



## Absolute Maximum Ratings (Notes 1, 2)

If Military/Aerospace specified devices are required, please contact the National Semiconductor Sales Office/Distributors for availability and specifications.

Supply Voltage ( $V_{DD}-V_{SS}$ )	15V
Voltage at Any Pin	$V_{SS} - 0.2V$ to $V_{DD} + 0.2V$
Power Dissipation (Note 3)	150 mW
ESD Susceptibility (Note 4)	2000V
Junction Temperature	150°C

Soldering Information		+ 260°C
N Package (10 sec.)		
Storage Temperature		- 65°C to + 150°C

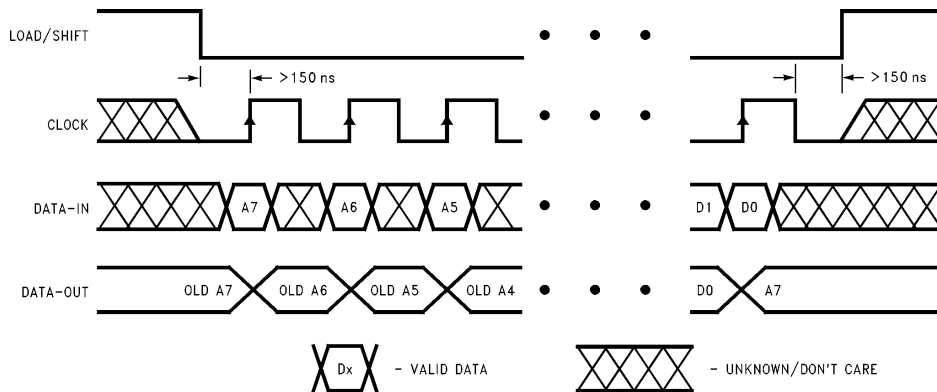
## Operating Ratings (Notes 1, 2)

Temperature Range	$T_{MIN}$	$T_A$	$T_{MAX}$
$T_{MIN} \leq T_A \leq T_{MAX}$	0°C	$\leq T_A$	$\leq +70^\circ C$
Supply Voltage ( $V_{DD} - V_{SS}$ )			4.5V to 12V

## Electrical Characteristics (Notes 1, 2)

The following specifications apply for all channels with  $V_{DD} = +6V$ ,  $V_{SS} = -6V$ ,  $V_{IN} = 5.5$  Vpk, and  $f = 1$  kHz, unless otherwise specified. Limits apply for  $T_A = 25^\circ C$ . Digital inputs are TTL and CMOS compatible.

Symbol	Parameter	Conditions	LM1972		Units (Limits)
			Typical (Note 5)	Limit (Note 6)	
$I_S$	Supply Current	Inputs are AC Grounded	2	4	mA (max)
THD + N	Total Harmonic Distortion plus Noise	$V_{IN} = 0.5$ Vpk @ 0dB Attenuation	0.0008	0.003	% (max)
XTalk	Crosstalk (Channel Separation)	0dB Attenuation for $V_{IN}$ $V_{CH}$ measured @ -78dB	110	100	dB (min)
SNR	Signal-to-Noise Ratio	Inputs are AC Grounded @ -12dB Attenuation A-Weighted	120	110	dB (min)
$A_M$	Mute Attenuation		104	96	dB (min)
	Attenuation Step Size Error	0dB to -47.5dB -48dB to -78dB		$\pm 0.05$ $\pm 0.25$	dB (max) dB (max)
	Absolute Attenuation Error	Attenuation @ 0dB	0.03	0.5	dB (min)
		Attenuation @ -20dB	19.8	19.0	dB (min)
		Attenuation @ -40dB	39.5	39.0	dB (min)
Attenuation @ -60dB		59.3	57.5	dB (min)	
	Attenuation @ -78dB	76.3	74.5	dB (min)	
	Channel-to-Channel Attenuation Tracking Error	Attenuation @ 0dB, -20dB, -40dB, -60dB Attenuation @ -78dB		$\pm 0.5$ $\pm 0.75$	dB (max) dB (max)
$I_{LEAK}$	Analog Input Leakage Current	Inputs are AC Grounded	10.0	100	nA (max)



TL/H/11978-3

FIGURE 2. Timing Diagram

## Electrical Characteristics (Notes 1, 2)

The following specifications apply for all channels with  $V_{DD} = +6V$ ,  $V_{SS} = -6V$ ,  $V_{IN} = 5.5$  Vpk, and  $f = 1$  kHz, unless otherwise specified. Limits apply for  $T_A = 25^\circ C$ . Digital inputs are TTL and CMOS compatible. (Continued)

Symbol	Parameter	Conditions	LM1972		Units (Limits)
			Typical (Note 5)	Limit (Note 6)	
$R_{IN}$	AC Input Impedance	Pins 4, 20, $V_{IN} = 1.0$ Vpk, $f = 1$ kHz	40	20 60	$k\Omega$ (min) $k\Omega$ (max)
$I_{IN}$	Input Current	@ Pins 9, 10, 11 @ $0V < V_{IN} < 5V$	1.0	$\pm 100$	nA (max)
$f_{CLK}$	Clock Frequency		3	2	MHz (max)
$V_{IH}$	High-Level Input Voltage	@ Pins 9, 10, 11		2.0	V (min)
$V_{IL}$	Low-Level Input Voltage	@ Pins 9, 10, 11		0.8	V (max)
	Data-Out Levels (Pin 12)	$V_{DD} = 6V$ , $V_{SS} = 0V$		0.1 5.9	V (max) V (min)

**Note 1:** All voltages are measured with respect to GND pins (1, 3, 5, 6, 14, 16, 19), unless otherwise specified.

**Note 2:** *Absolute Maximum Ratings* indicate limits beyond which damage to the device may occur. *Operating Ratings* indicate conditions for which the device is functional, but do not guarantee specific performance limits. *Electrical Characteristics* state DC and AC electrical specifications under particular test conditions which guarantee specific performance limits. This assumes that the device is within the Operating Ratings. Specifications are not guaranteed for parameters where no limit is given, however, the typical value is a good indication of device performance.

**Note 3:** The maximum power dissipation must be derated at elevated temperatures and is dictated by  $T_{JMAX}$ ,  $\theta_{JA}$ , and the ambient temperature  $T_A$ . The maximum allowable power dissipation is  $P_D = (T_{JMAX} - T_A) / \theta_{JA}$  or the number given in the Absolute Maximum Ratings, whichever is lower. For the LM1972,  $T_{JMAX} = +150^\circ C$ , and the typical junction-to-ambient thermal resistance, when board mounted, is  $65^\circ C/W$ .

**Note 4:** Human body model, 100 pF discharged through a 1.5 k $\Omega$  resistor.

**Note 5:** Typicals are measured at  $25^\circ C$  and represent the parametric norm.

**Note 6:** Limits are guaranteed to National's AOQL (Average Output Quality Level).

## Pin Description

**Signal Ground (3, 19):** Each input has its own independent ground, GND1 and GND2.

**Signal Input (4, 20):** There are 2 independent signal inputs, IN1 and IN2.

**Signal Output (2, 17):** There are 2 independent signal outputs, OUT1 and OUT2.

**Voltage Supply (13, 15):** Positive voltage supply pins,  $V_{DD1}$  and  $V_{DD2}$ .

**Voltage Supply (7, 18):** Negative voltage supply pins,  $V_{SS1}$  and  $V_{SS2}$ . To be tied to ground in a single supply configuration.

**AC Ground (1, 5, 6, 14, 16):** These five pins are not physically connected to the die in any way (i.e., No bondwires). These pins must be AC grounded to prevent signal coupling between any of the pins nearby. Pin 14 should be connected to pins 13 and 15 for ease of wiring and the best isolation, as an example.

**Logic Ground (8):** Digital signal ground for the interface lines; CLOCK, LOAD/SHIFT, DATA-IN and DATA-OUT.

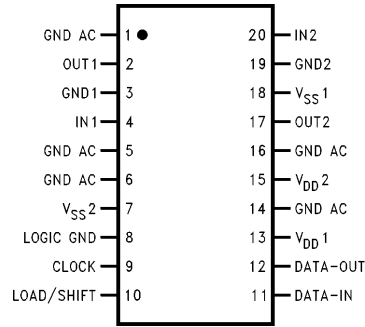
**Clock (9):** The clock input accepts a TTL or CMOS level signal. The clock input is used to load data into the internal shift register on the rising edge of the input clock waveform.

**Load/Shift (10):** The load/shift input accepts a TTL or CMOS level signal. This is the enable pin of the device, allowing data to be clocked in while this input is low (0V).

**Data-In (11):** The data-in input accepts a TTL or CMOS level signal. This pin is used to accept serial data from a microcontroller that will be latched and decoded to change a channel's attenuation level.

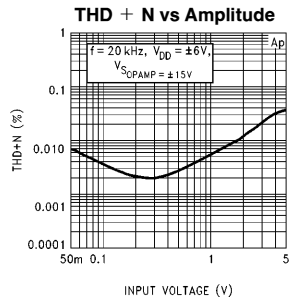
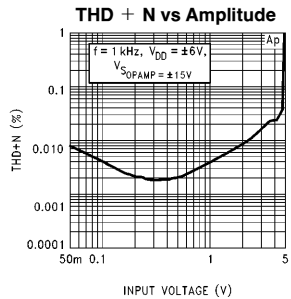
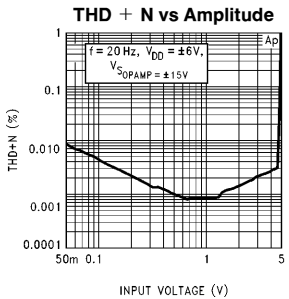
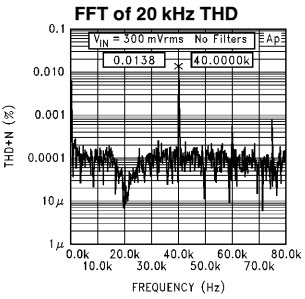
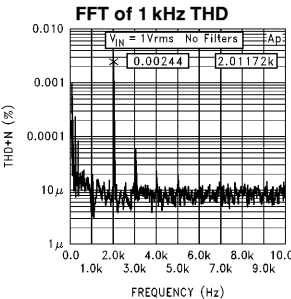
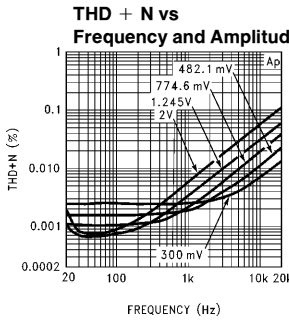
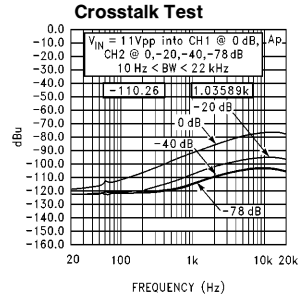
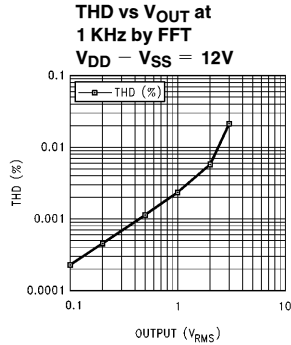
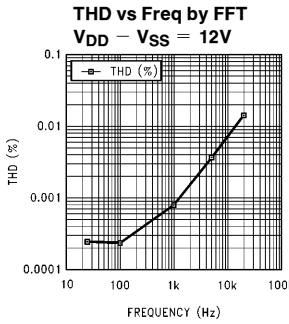
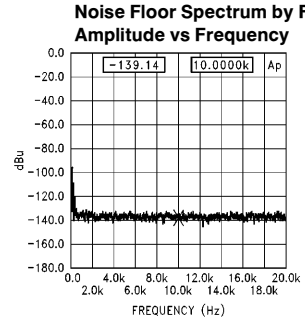
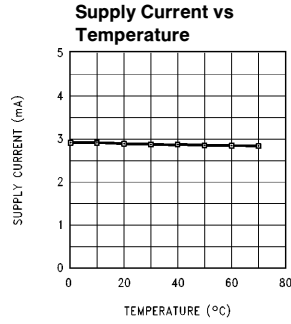
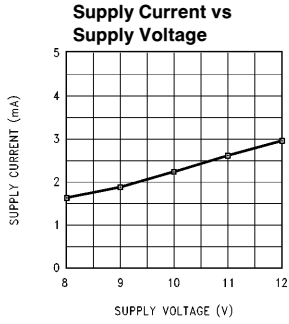
**Data-Out (12):** This pin is used in daisy-chain mode where more than one  $\mu$ Pot is controlled via the same data line. As the data is clocked into the chain from the  $\mu$ C, the preceding data in the shift register is shifted out the DATA-OUT pin to the next  $\mu$ Pot in the chain or to ground if it is the last  $\mu$ Pot in the chain. The LOAD/SHIFT line goes high once all of the new data has been shifted into each of its respective registers.

## Connection Diagram



TL/H/11978-4

# Typical Performance Characteristics

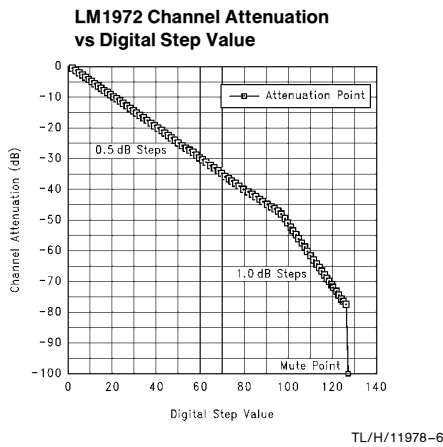


TL/H/11978-5

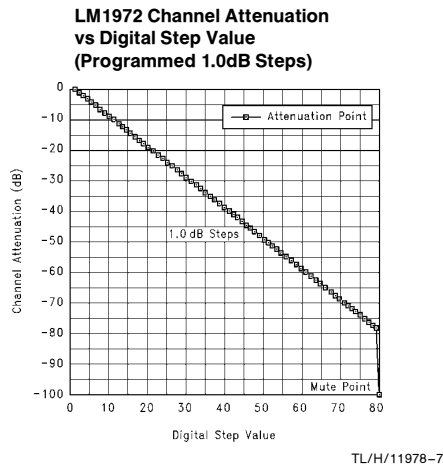
# Application Information

## ATTENUATION STEP SCHEME

The fundamental attenuation step scheme for the LM1972  $\mu$ Pot is shown in *Figure 3*. This attenuation step scheme, however, can be changed through programming techniques to fit different application requirements. One such example would be a constant logarithmic attenuation scheme of 1dB steps for a panning function as shown in *Figure 4*. The only restriction to the customization of attenuation schemes are the given attenuation levels and their corresponding data bits shown in Table I. The device will change attenuation levels only when a channel address is recognized. When recognized, the attenuation level will be changed corresponding to the data bits shown in Table I. As shown in *Figure 6*, an LM1972 can be configured as a panning control which separates the mono signal into left and right channels. This circuit may utilize the fundamental attenuation scheme of the LM1972 or be programmed to provide a constant 1dB logarithmic attenuation scheme as shown in *Figure 4*.

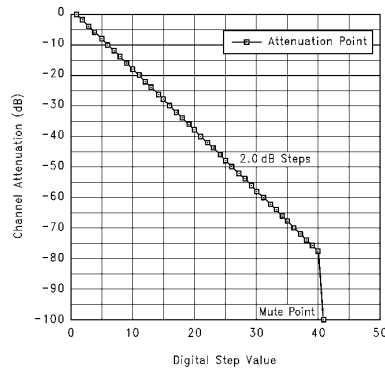


**FIGURE 3. LM1972 Attenuation Step Scheme**

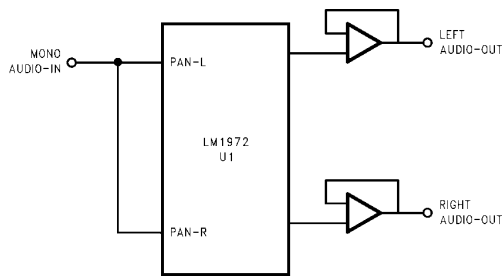


**FIGURE 4. LM1972 1.0dB Attenuation Step Scheme**

## LM1972 Channel Attenuation vs Digital Step Value (Programmed 2.0dB Steps)



**FIGURE 5. LM1972 2.0dB Attenuation Step Scheme**



**FIGURE 6. Mono Panning Circuit**

### INPUT IMPEDANCE

The input impedance of a  $\mu$ Pot is constant at a nominal 40 k $\Omega$ . To eliminate any unwanted DC components from propagating through the device it is common to use 1  $\mu$ F input coupling caps. This is not necessary, however, if the dc offset from the previous stage is negligible. For higher performance systems, input coupling caps are preferred.

### OUTPUT IMPEDANCE

The output of a  $\mu$ Pot varies typically between 25 k $\Omega$  and 35 k $\Omega$  and changes nonlinearly with step changes. Since a  $\mu$ Pot is made up of a resistor ladder network with a logarithmic attenuation, the output impedance is nonlinear. Due to this configuration, a  $\mu$ Pot cannot be considered as a linear potentiometer, but can be considered only as a logarithmic attenuator.

It should be noted that the linearity of a  $\mu$ Pot cannot be measured directly without a buffer because the input impedance of most measurement systems is not high enough to provide the required accuracy. Due to the low impedance of the measurement system, the output of the  $\mu$ Pot would be loaded down and an incorrect reading will result. To prevent loading from occurring, a JFET input op amp should be used as the buffer/amplifier. The performance of a  $\mu$ Pot is limited only by the performance of the external buffer/amplifier.

## Application Information (Continued)

### MUTE FUNCTION

One major feature of a  $\mu$ Pot is its ability to mute the input signal to an attenuation level of 104dB as shown in *Figure 3*. This is accomplished internally by physically isolating the output from the input while also grounding the output pin through approximately 2 k $\Omega$ .

The mute function is obtained during power-up of the device or by sending any binary data of 01111111 and above (to 11111111) serially to the device. The device may be placed into mute from a previous attenuation setting by sending any of the above data. This allows the designer to place a mute button onto his system which could cause a microcontroller to send the appropriate data to a  $\mu$ Pot and thus mute any or all channels. Since this function is achieved through software, the designer has a great amount of flexibility in configuring the system.

### DC INPUTS

Although the  $\mu$ Pot was designed to be used as an attenuator for signals within the audio spectrum, the device is capable of tracking an input DC voltage. The device will track DC voltages to a diode drop above each supply rail.

One point to remember about DC tracking is that with a buffer at the output of the  $\mu$ Pot, the resolution of DC tracking will depend upon the gain configuration of that output buffer and its supply voltage. It should also be remembered that the output buffer's supply voltage does not have to be the same as the  $\mu$ Pot's supply voltage. This could allow for more resolution when DC tracking.

### SERIAL DATA FORMAT

The LM1972 uses a 3-wire serial communication format that is easily controlled by a microcontroller. The timing for the 3-wire set, comprised of DATA-IN, CLOCK, and LOAD/SHIFT is shown in *Figure 2*. *Figure 8* exhibits in block diagram form how the digital interface controls the tap switches which select the appropriate attenuation level. As depicted in *Figure 2*, the LOAD/SHIFT line is to go low at least 150 ns before the rising edge of the first clock pulse and is to remain low throughout the transmission of each set of 16 data bits. The serial data is comprised of 8 bits for channel selection and 8 bits for attenuation setting. For both address data and attenuation setting data, the MSB is sent first and the 8 bits of address data are to be sent before the 8 bits of attenuation data. Please refer to *Figure 7* to confirm the serial data format transfer process.

TABLE I. LM1972 Micropot Attenuator Register Set Description

MSB	LSB
<b>Address Register (Byte 0)</b>	
0000 0000	Channel 1
0000 0001	Channel 2
0000 0010	Channel 3
<b>Data Register (Byte 1)</b>	
Contents	Attenuation Level dB
0000 0000	0.0
0000 0001	0.5
0000 0010	1.0
0000 0011	1.5
:: :::	::
0001 1110	15.0
0001 1111	15.5
0010 0000	16.0
0010 0001	16.5
0010 0010	17.0
:: :::	::
0101 1110	47.0
0101 1111	47.5
0110 0000	48.0
0110 0001	49.0
0110 0010	50.0
:: :::	::
0111 1100	76.0
0111 1101	77.0
0111 1110	78.0
0111 1111	100.0 (Mute)
1000 0000	100.0 (Mute)
:: :::	::
1111 1110	100.0 (Mute)
1111 1111	100.0 (Mute)

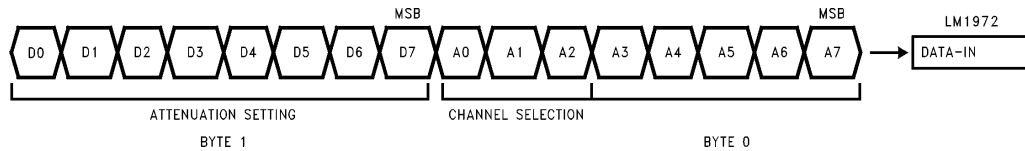


FIGURE 7. Serial Data Format Transfer Process

TL/H/11978-10

## Application Information (Continued)

### $\mu$ Pot SYSTEM ARCHITECTURE

The  $\mu$ Pot's digital interface is essentially a shift register, where serial data is shifted in, latched, and then decoded. As new data is shifted into the DATA-IN pin, the previously latched data is shifted out the DATA-OUT pin. Once the data is shifted in, the LOAD/SHIFT line goes high, latching in the new data. The data is then decoded and the appropriate switch is activated to set the desired attenuation level for the selected channel. This process is continued each and every time an attenuation change is made. Each channel is updated, only, when that channel is selected for an attenuator change or the system is powered down and then back up again. When the  $\mu$ Pot is powered up, each channel is placed into the muted mode.

### $\mu$ Pot LADDER ARCHITECTURE

Each channel of a  $\mu$ Pot has its own independent resistor ladder network. As shown in *Figure 9*, the ladder consists of multiple R1/R2 elements which make up the attenuation scheme. Within each element there are tap switches that select the appropriate attenuation level corresponding to the data bits in Table I. It can be seen in *Figure 9* that the input impedance for the channel is a constant value regardless of which tap switch is selected, while the output impedance varies according to the tap switch selected.

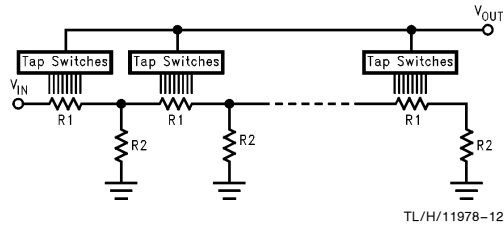


FIGURE 9.  $\mu$ Pot Ladder Architecture

### DIGITAL LINE COMPATIBILITY

The  $\mu$ Pot's digital interface section is compatible with either TTL or CMOS logic due to the shift register inputs acting upon a threshold voltage of 2 diode drops or approximately 1.4V.

### DIGITAL DATA-OUT PIN

The DATA-OUT pin is available for daisy-chain system configurations where multiple  $\mu$ Pots will be used. The use of the daisy-chain configuration allows the system designer to use only one DATA and one LOAD/SHIFT line per chain, thus simplifying PCB trace layouts.

In order to provide the highest level of channel separation and isolate any of the signal lines from digital noise, the DATA-OUT pin should be terminated through a 2 k $\Omega$  resistor if not used. The pin may be left floating, however, any signal noise on that line may couple to adjacent lines creating higher noise specs.

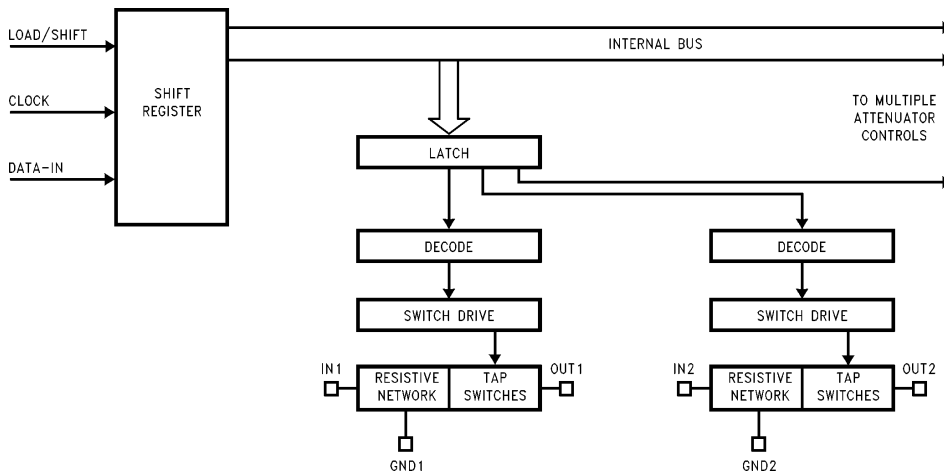


FIGURE 8.  $\mu$ Pot System Architecture

TL/H/11978-11



## Application Information (Continued)

### DAISY-CHAIN CAPABILITY

Since the  $\mu$ Pot's digital interface is essentially a shift register, multiple  $\mu$ Pots can be programmed utilizing the same data and load/shift lines. As shown in *Figure 10*, for an  $n$ - $\mu$ Pot daisy-chain, there are  $16n$  bits to be shifted and loaded for the chain. The data loading sequence is the same for  $n$ - $\mu$ Pots as it is for one  $\mu$ Pot. First the LOAD/SHIFT line goes low, then the data is clocked in sequentially while the preceding data in each  $\mu$ Pot is shifted out the DATA-OUT pin to the next  $\mu$ Pot in the chain or to ground if it is the last  $\mu$ Pot in the chain. Then the LOAD/SHIFT line goes high; latching the data into each of their corresponding  $\mu$ Pots. The data is then decoded according to the address (channel selection) and the appropriate tap switch controlling the attenuation level is selected.

### CROSSTALK MEASUREMENTS

The crosstalk of a  $\mu$ Pot as shown in the **Typical Performance Characteristics** section was obtained by placing a signal on one channel and measuring the level at the output of another channel of the same frequency. It is important to be sure that the signal level being measured is of the same frequency such that a true indication of crosstalk may be obtained. Also, to ensure an accurate measurement, the measured channel's input should be AC grounded through a  $1\ \mu\text{F}$  capacitor.

### CLICKS AND POPS

So, why is that output buffer needed anyway? There are three answers to this question, all of which are important from a system point of view.

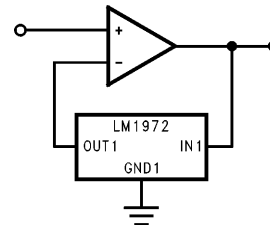
The first reason to utilize a buffer/amplifier at the output of a  $\mu$ Pot is to ensure that there are no audible clicks or pops due to attenuation step changes in the device. If an on-board bipolar op amp had been used for the output stage, its requirement of a finite amount of DC bias current for operation would cause a DC voltage "pop" when the output impedance of the  $\mu$ Pot changes. Again, this phenomenon is due to the fact that the output impedance of the  $\mu$ Pot is changing with step changes and a bipolar amplifier requires a finite amount of DC bias current for its operation. As the impedance changes, so does the DC bias current and thus there is a DC voltage "pop".

Secondly, the  $\mu$ Pot has no drive capability, so any desired gain needs to be accomplished through a buffer/non-inverting amplifier.

Third, the output of a  $\mu$ Pot needs to see a high impedance to prevent loading and subsequent linearity errors from occurring. A JFET input buffer provides a high input impedance to the output of the  $\mu$ Pot so that this does not occur. Clicks and pops can be avoided by using a JFET input buffer/amplifier such as an LF412ACN. The LF412 has a high input impedance and exhibits both a low noise floor and low THD+N throughout the audio spectrum which maintains signal integrity and linearity for the system. The performance of the system solution is entirely dependent upon the quality and performance of the JFET input buffer/amplifier.

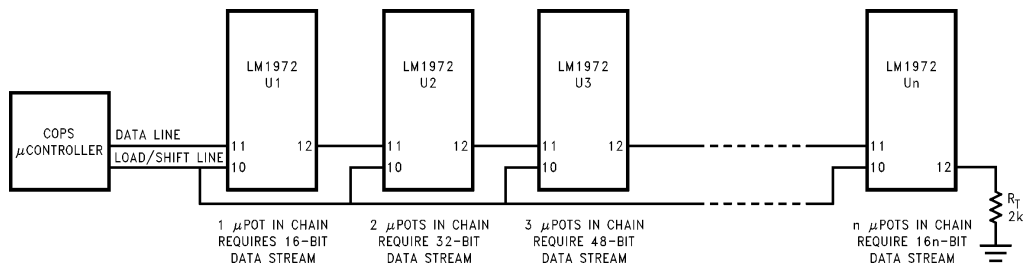
### LOGARITHMIC GAIN AMPUFIER

The  $\mu$ Pot is capable of being used in the feedback loop of an amplifier, however, as stated previously, the output of the  $\mu$ Pot needs to see a high impedance in order to maintain its high performance and linearity. Again, loading the output will change the values of attenuation for the device. As shown in *Figure 11*, a  $\mu$ Pot used in the feedback loop creates a logarithmic gain amplifier. In this configuration the attenuation levels from Table I, now become gain levels with the largest possible gain value being 78dB. For most applications 78dB of gain will cause signal clipping to occur, however, because of the  $\mu$ Pot's versatility the gain can be controlled through programming such that the clipping level of the system is never obtained. An important point to remember is that when in mute mode the input is disconnected from the output. In this configuration this will place the amplifier in its open loop gain state, thus resulting in severe comparator action. Care should be taken with the programming and design of this type of circuit. To provide the best performance, a JFET input amplifier should be used.



TL/H/11978-14

**FIGURE 11. Digitally-Controlled Logarithmic Gain Amplifier Circuit**

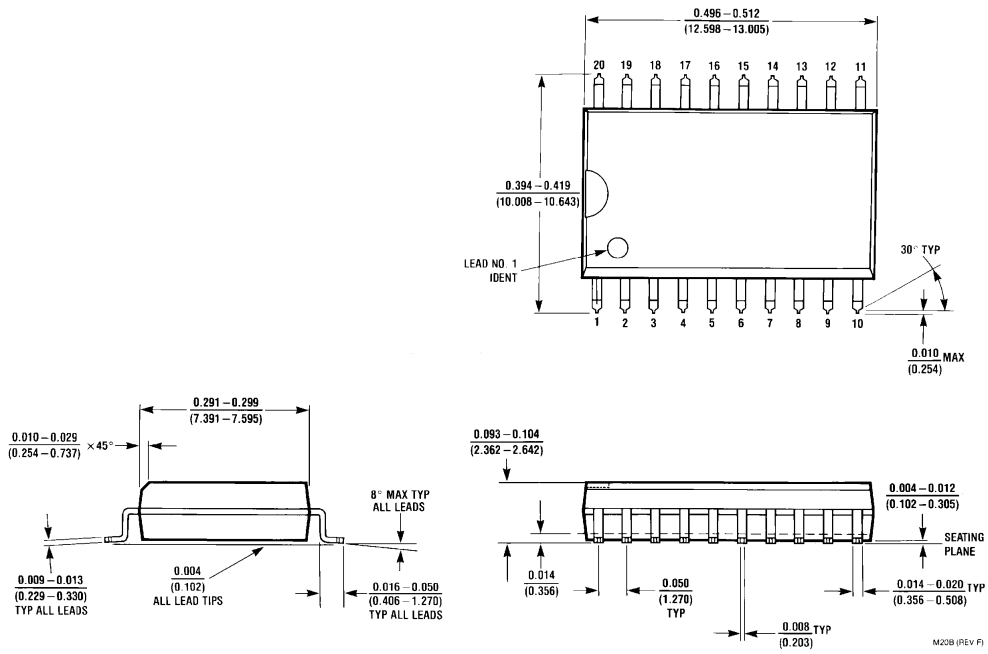


TL/H/11978-13

**FIGURE 10. n- $\mu$ Pot Daisy-Chained Circuit**



**Physical Dimensions** inches (millimeters)

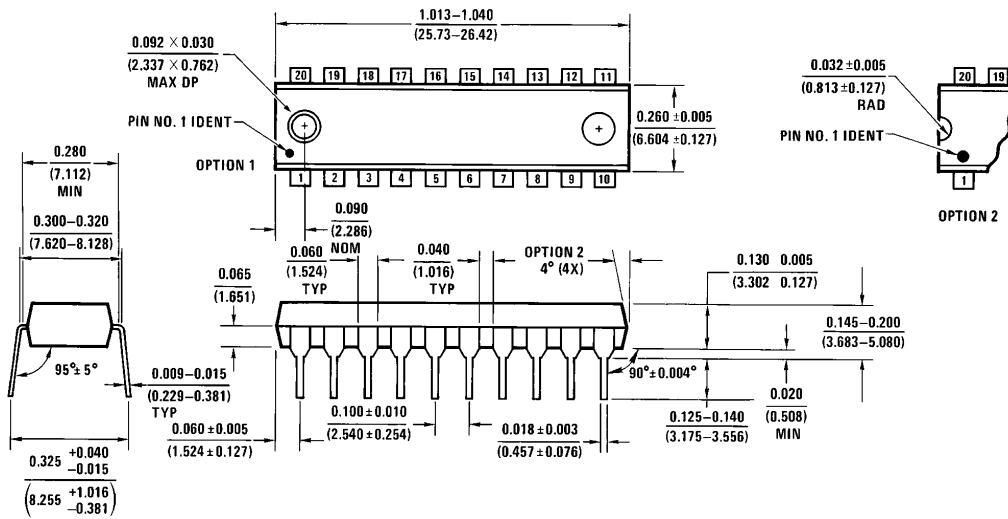


**Surface Mount Package**  
**Order Number LM1972M**  
**NS Package Number M20B**

M20B (REV. F)

LM1972  $\mu$ Pot 2-Channel Attenuator with Mute

**Physical Dimensions** inches (millimeters) (Continued)



**Dual-In-Line Plastic Package**  
**Order Number LM1972N**  
**NS Package Number N20A**

N20A (REV G)

**LIFE SUPPORT POLICY**

NATIONAL'S PRODUCTS ARE NOT AUTHORIZED FOR USE AS CRITICAL COMPONENTS IN LIFE SUPPORT DEVICES OR SYSTEMS WITHOUT THE EXPRESS WRITTEN APPROVAL OF THE PRESIDENT OF NATIONAL SEMICONDUCTOR CORPORATION. As used herein:

1. Life support devices or systems are devices or systems which, (a) are intended for surgical implant into the body, or (b) support or sustain life, and whose failure to perform, when properly used in accordance with instructions for use provided in the labeling, can be reasonably expected to result in a significant injury to the user.
2. A critical component is any component of a life support device or system whose failure to perform can be reasonably expected to cause the failure of the life support device or system, or to affect its safety or effectiveness.



**National Semiconductor Corporation**  
 2900 Semiconductor Drive  
 P.O. Box 58090  
 Santa Clara, CA 95052-8090  
 Tel: (408) 272-9959  
 TWX: (910) 339-9240

**National Semiconductor GmbH**  
 Livny-Gargan-Str. 10  
 D-82256 Fürstenfeldbruck  
 Germany  
 Tel: (81-41) 35-0  
 Telex: 527849  
 Fax: (81-41) 35-1

**National Semiconductor Japan Ltd.**  
 Sumitomo Chemical  
 Engineering Center  
 Bldg. 7F  
 Tsimshatsui, Kowloon  
 Hong Kong  
 1-7-1, Nakase, Mihama-Ku  
 Chiba-City,  
 Ciba Prefecture 261  
 Tel: (043) 299-2300  
 Fax: (043) 299-2500

**National Semiconductor Hong Kong Ltd.**  
 13th Floor, Straight Block,  
 Ocean Centre, 5 Canton Rd.  
 Tsimshatsui, Kowloon  
 Hong Kong  
 Tel: (852) 2737-1600  
 Fax: (852) 2736-9960

**National Semicondutores Do Brazil Ltda.**  
 Rue Deputado Lacorda Franco  
 120-3A  
 Sao Paulo-SP  
 Brazil 05418-000  
 Tel: (55-11) 212-5066  
 Telex: 391-1131931 NSBR BR  
 Fax: (55-11) 212-1181

**National Semiconductor (Australia) Pty. Ltd.**  
 Building 16  
 Business Park Drive  
 Monash Business Park  
 Nottinghill, Melbourne  
 Victoria 3168 Australia  
 Tel: (3) 558-9999  
 Fax: (3) 558-9998

National does not assume any responsibility for use of any circuitry described, no circuit patent licenses are implied and National reserves the right at any time without notice to change said circuitry and specifications.