

# Acer TravelMate 270 Series

## Service Guide

Service guide files and updates are available on the ACER/CSD web; for more information, please refer to <http://csd.acer.com.tw>

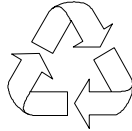

100% Recycled Paper

PART NO.: VD.T18V5.001

PRINTED IN TAIWAN

---

# Revision History

Please refer to the table below for the updates made on TravelMate 270 service guide.

Date	Chapter	Updates

---

## Copyright

Copyright © 2002 by Acer Incorporated. All rights reserved. No part of this publication may be reproduced, transmitted, transcribed, stored in a retrieval system, or translated into any language or computer language, in any form or by any means, electronic, mechanical, magnetic, optical, chemical, manual or otherwise, without the prior written permission of Acer Incorporated.

## Disclaimer

The information in this guide is subject to change without notice.

Acer Incorporated makes no representations or warranties, either expressed or implied, with respect to the contents hereof and specifically disclaims any warranties of merchantability or fitness for any particular purpose. Any Acer Incorporated software described in this manual is sold or licensed "as is". Should the programs prove defective following their purchase, the buyer (and not Acer Incorporated, its distributor, or its dealer) assumes the entire cost of all necessary servicing, repair, and any incidental or consequential damages resulting from any defect in the software.

Acer is a registered trademark of Acer Corporation.

Intel is a registered trademark of Intel Corporation.

Pentium and Pentium II/III are trademarks of Intel Corporation.

Other brand and product names are trademarks and/or registered trademarks of their respective holders.

---

## Conventions

The following conventions are used in this manual:

<b>SCREEN MESSAGES</b>	Denotes actual messages that appear on screen.
<b>NOTE</b>	Gives bits and pieces of additional information related to the current topic.
<b>WARNING</b>	Alerts you to any damage that might result from doing or not doing specific actions.
<b>CAUTION</b>	Gives precautionary measures to avoid possible hardware or software problems.
<b>IMPORTANT</b>	Reminds you to do specific actions relevant to the accomplishment of procedures.

---

## Preface

Before using this information and the product it supports, please read the following general information.

1. This Service Guide provides you with all technical information relating to the BASIC CONFIGURATION decided for Acer's "global" product offering. To better fit local market requirements and enhance product competitiveness, your regional office MAY have decided to extend the functionality of a machine (e.g. add-on card, modem, or extra memory capability). These LOCALIZED FEATURES will NOT be covered in this generic service guide. In such cases, please contact your regional offices or the responsible personnel/channel to provide you with further technical details.
2. Please note WHEN ORDERING FRU PARTS, that you should check the most up-to-date information available on your regional web or channel. If, for whatever reason, a part number change is made, it will not be noted in the printed Service Guide. For ACER-AUTHORIZED SERVICE PROVIDERS, your Acer office may have a DIFFERENT part number code to those given in the FRU list of this printed Service Guide. You MUST use the list provided by your regional Acer office to order FRU parts for repair and service of customer machines.

<b>Chapter 1</b>	<b>System Specifications</b>	<b>3</b>
	Features .....	3
	System Block Diagram .....	5
	Board Layout .....	6
	Top View .....	6
	Bottom View .....	7
	Outlook View .....	8
	Front View .....	8
	Left Panel .....	10
	Right Panel .....	11
	Rear Panel .....	12
	Bottom Panel .....	13
	Indicators .....	14
	Lock Keys .....	15
	Embedded Numeric Keypad .....	16
	Windows Keys .....	17
	Hot Keys .....	18
	The Euro Symbol .....	20
	Launch Keys .....	21
	E-Mail Detection .....	22
	Touchpad .....	23
	Touchpad Basics .....	23
	Hardware Specifications and Configurations .....	25
<b>Chapter 2</b>	<b>System Utilities</b>	<b>37</b>
	BIOS Setup Utility .....	37
	Navigating the BIOS Utility .....	37
	Main .....	39
	System Devices .....	41
	Security .....	42
	Boot .....	46
	Info. ....	47
	Exit .....	48
	BIOS Flash Utility .....	49
	System Utility Diskette .....	49
	System Diagnostic Diskette .....	49
	Running Diagnostics Program .....	50
<b>Chapter 3</b>	<b>Machine Disassembly and Replacement</b>	<b>55</b>
	General Information .....	56
	Before You Begin .....	56
	Disassembly Procedure Flowchart .....	57
	Removing the HDD Module/Memory/FDD Module/Optical Module and CPU .....	60
	Removing the HDD Module .....	60
	Removing the Memory .....	60
	Removing the FDD Module .....	60
	Removing the Optical Module .....	60
	Removing the CPU .....	61
	Removing the LCD Module and Switch Board .....	63
	Removing the LCD Module .....	63
	Removing the Switch Board .....	64
	Disassembling the Main Unit .....	65
	Separate the main unit into the logic upper and the logic lower assembly ...	65
	Disassembling the logic upper .....	65

# Table of Contents

Disassembling the logic lower . . . . .	67
Disassembling the LCD Module . . . . .	68
Disassembling the External Modules . . . . .	69
Disassembling the HDD Module . . . . .	69
Disassembling the Floppy Disk Drive Module . . . . .	69
Disassembling the Optical Drive Module . . . . .	69
<b>Chapter 4 Troubleshooting</b>	<b>71</b>
System Check Procedures . . . . .	72
External Diskette Drive Check . . . . .	72
External CD-ROM/DVD-ROM Drive Check . . . . .	72
Keyboard or Auxiliary Input Device Check . . . . .	73
Memory Check . . . . .	73
Power System Check . . . . .	73
Touchpad Check . . . . .	75
Display Check . . . . .	75
Sound Check . . . . .	76
Power-On Self-Test (POST) Error Message . . . . .	77
Index of Error Messages . . . . .	78
Index of Symptom-to-FRU Error Message . . . . .	80
Intermittent Problems . . . . .	83
Undetermined Problems . . . . .	84
Index of AFlash BIOS Error Message . . . . .	85
<b>Chapter 5 Jumper and Connector Locations</b>	<b>87</b>
Top View . . . . .	87
SW1 Settings (Lid switch) . . . . .	88
SW2 Settings . . . . .	88
Bottom View . . . . .	89
<b>Chapter 6 FRU (Field Replaceable Unit) List</b>	<b>91</b>
TravelMate 270 Series . . . . .	108
<b>Appendix A Model Definition and Configuration</b>	<b>108</b>
Main Features . . . . .	109
<b>Appendix B Test Compatible Components</b>	<b>111</b>
Microsoft® Window® XP Home Environment Test . . . . .	112
Microsoft® Window® XP Pro Environment Test . . . . .	114
Microsoft® Window® 2000 Environment Test . . . . .	116
<b>Appendix C Online Support Information</b>	<b>119</b>
<b>Index</b>	<b>121</b>

# System Specifications

---

## Features

This computer was designed with the user in mind. Here are just a few of its many features:

### Performance

- Mobile Intel® Pentium®4 processor-M at 1.4GHz or higher
- Built-in 0.13 micron technology; includes 512KB L2 Cache; supports Enhanced Intel® SpeedStep™ technology
- Standard 128/256MB DDR-266 SDRAM, upgradeable up to 1GB on dual SoDIMM sockets
- 14.1" or 15.0" XGA TFT color LCD, 1024x768, 16.7M colours
- High-capacity, Enhanced-IDE hard disk
- Li-Ion main battery pack
- Power management system with ACPI (Advanced Configuration Power Interface)
- DualView™ support
- Simultaneous LCD and CRT display at 1024x768, 16.7M colours

### Display

- Thin-Film Transistor (TFT) liquid-crystal display (LCD) displaying 32-bit high true colour up to 16.7 million colours at 1024X768 eXtended Graphics Array (XGA) resolution for 14.1"/15.0" or 1400x1050 Super eXtended Graphics Array+ (SXGA+) for resolution for some 15.0" models (specification varies depending on models)
- 3D capabilities
- S-video for output to a television or display device that supports S-video input
- "Automatic LCD dim" feature that automatically decides the best settings for your display and conserves power
- Simultaneous LCD and CRT display at 1024x768, 16.7M colours
- SiS 650 with integrated VGA, default shared 16MB DDR video memory (or 32/64MB configured via BIOS)
- 4x AGP graphics accelerator
- MPEG-2/DVD hardware assisted capability

### Multimedia

- high-fidelity AC'97 stereo audio
- Built-in dual speakers
- Built-in microphone
- SoundBlaster-Pro and MS DirectSound compatible
- High-speed optical drive
- S-video (NTSC/PAL) output

### Connectivity

- High-speed fax/data modem port
- Ethernet/Fast Ethernet port



- 
- USB (Universal Serial Bus) ports
  - IEEE 1394 port
  - 802.11b wireless LAN

### **Keyboard and Pointing Device**

- 4-way scroll button
- Sleek, smooth and stylish design
- Full-sized keyboard
- Ergonomically-centered touchpad pointing device

### **Expansion**

- Two type II or one type III cardBus PC Card slots
- Upgradeable memory

### **Keyboard and Pointing Device**

- Acer FineTouch keyboard: with a 5° curve, 84/85/88-key, inverted “T” cursor layout, 18mm spacing, 2.5mm(min) key travel
- Built-in touchpad pointing device with ergonomic buttons and 4-way integrated scroll key
- 12 function keys; 4 cursor keys; two Windows® keys; hotkey controls
- 5 launch keys, including Internet browser, email (with LED for received mail), and 3 user-programmable keys
- Acer InviLink™ button for wireless models
- Embedded numeric keypad
- International language support

### **I/O Ports**

- Two CardBus Type II/One Type III slots
- One RJ-11 modem jack
- One RJ-45 network jack
- One DC-in jack for AC adapter
- One RS-232 (16550 compatible) serial port
- One ECP/EPP-compliant parallel port
- One PS/2-compatible keyboard/mouse port
- One external VGA port
- One speaker/microphone/line-in jack
- One microphone/line-in jack
- One S-video-out (NTSC/PAL) port
- Three Universal Serial Bus (USB) ports
- One IEEE 1394 port

# System Block Diagram

File Name : LA-1341

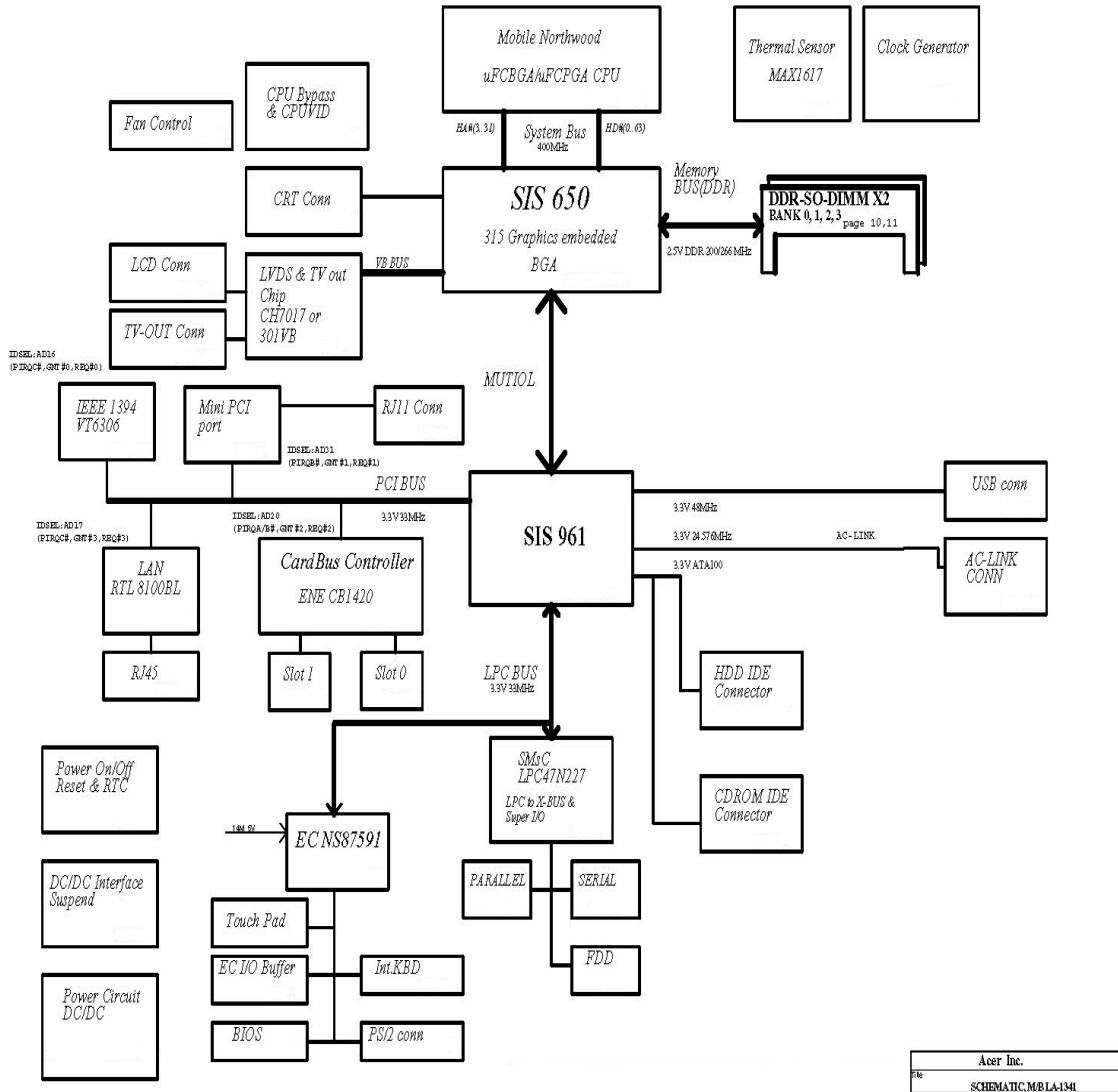

Acer Inc.  
File: SCHEMATIC.M0/LA-1341

# Board Layout

## Top View

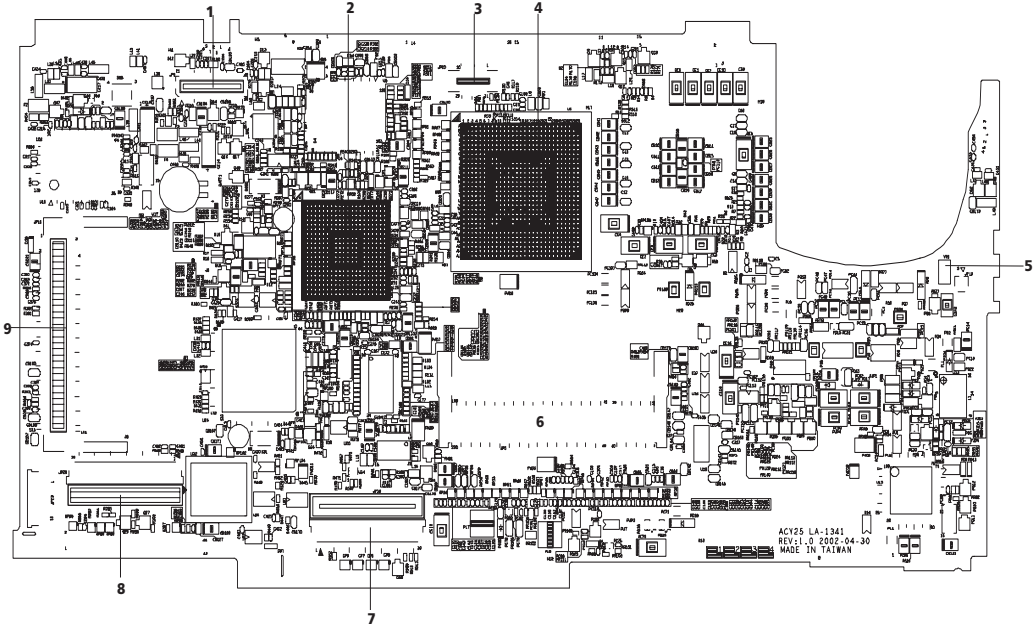

- |   |                                   |   |                               |
|---|-----------------------------------|---|-------------------------------|
| 1 | Panel connector                   | 6 | DDR-200P so DIMM connector    |
| 2 | Southbridge                       | 7 | Int. KB interface connector   |
| 3 | Switch button interface connector | 8 | Audio to main board connector |
| 4 | Northbridge                       | 9 | Mini PCI connector            |
| 5 | Modem connector                   |   |                               |

# Bottom View

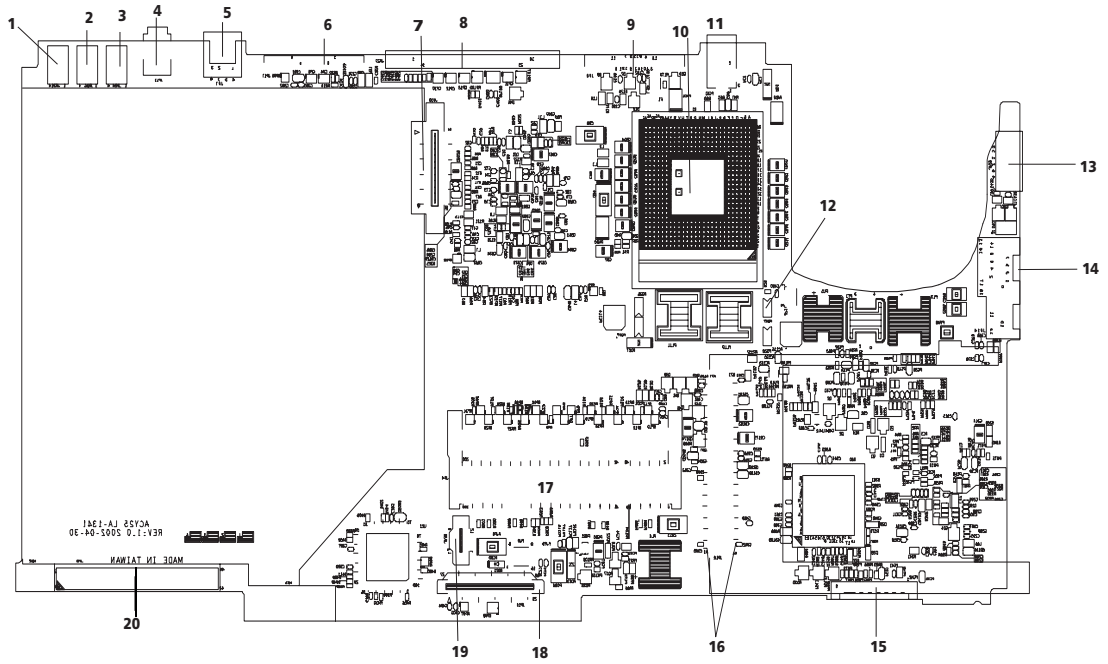

- |    |                    |    |                        |
|----|--------------------|----|------------------------|
| 1  | USB connector      | 11 | DC jack connector      |
| 2  | USB connector      | 12 | CPU fan connector      |
| 3  | USB connector      | 13 | Keyboard/PS2 connector |
| 4  | 1394 connector     | 14 | RJ45-11 connector      |
| 5  | TV-out connector   | 15 | Battery connector      |
| 6  | Serial port        | 16 | PCMCIA connector       |
| 7  | CD-ROM connector   | 17 | DDR 200P               |
| 8  | Parallel connector | 18 | FDD connector          |
| 9  | CRT connector      | 19 | Card reader connector  |
| 10 | CPU socket         | 20 | HDD connector          |

# Outlook View

A general introduction of ports allow you to connect peripheral devices, as you would with a desktop PC.

## Front View

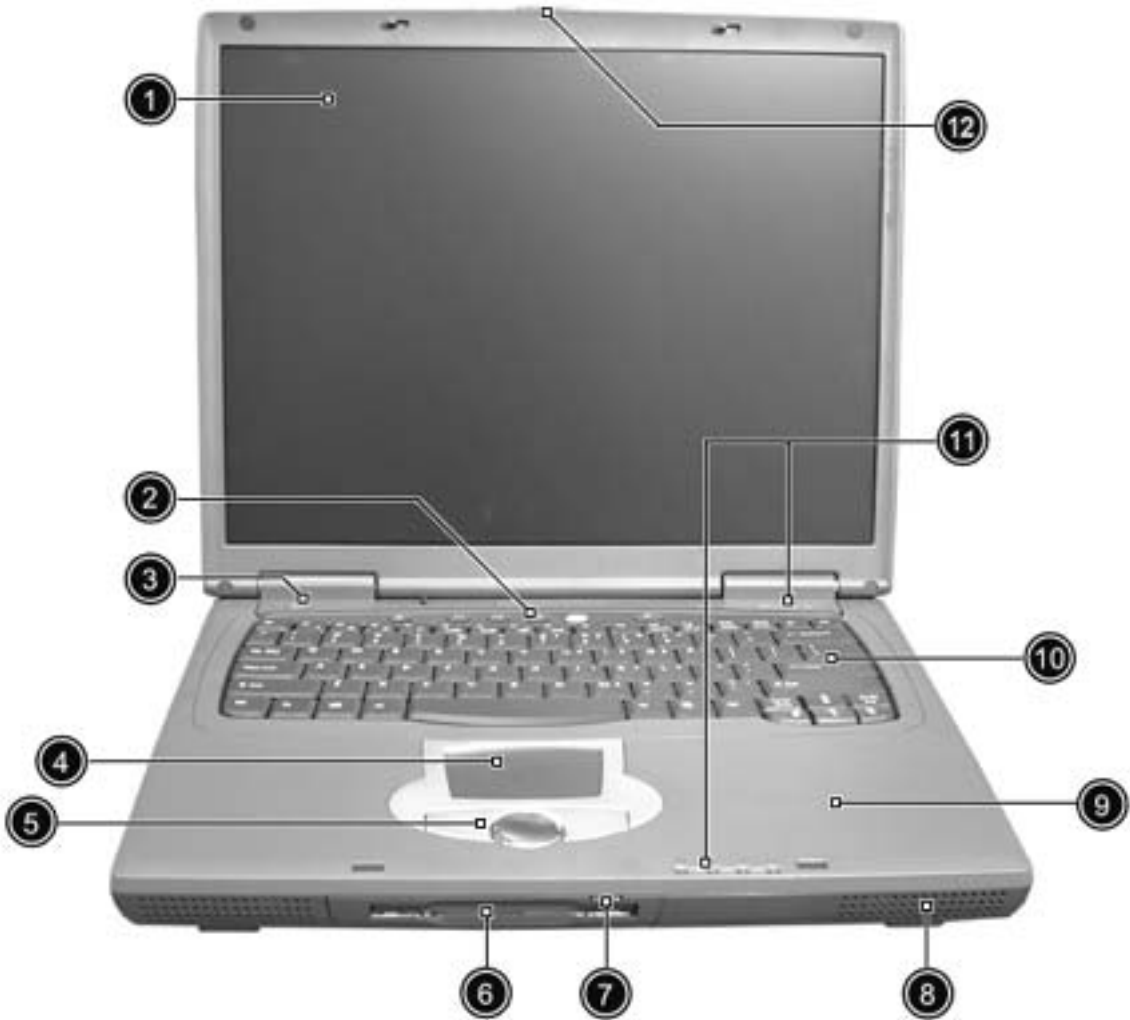

#	Icon	Item	Description
1	1	Display screen	Also called LCD (liquid-crystal display), displays computer output.
2		Launch keys	Special keys for launching Internet browser, E-mail program and frequently used programs. Located at the top of the keyboard are five buttons. They are designated as P1, P2, P3, E-mail button and Web browser button. P1, P2 and P3 launch user-programmable applications; E-mail and Web browser launch E-mail and Internet browser applications.
3		Power Switch	Turns on the computer power.

---

4		Touchpad	Touch-sensitive pointing device which functions like a computer mouse.
5		Click buttons (left, center and right)	The left and right buttons function like the left and right mouse buttons; the center button serves as a 4-way scroll button.
6		Floppy disk drive (or card reader if installed)	Reads/writes data from/to the media.
7		Floppy eject button	Ejects floppy disk.
8		Speakers	Outputs sound.
9		Palmrest	Comfortable support area for your hands when you use the computer. Outputs sound.
10		Keyboard	Inputs data into your computer.
11		Status indicators	LEDs (light-emitting diode) that turn on and off to show the status of the computer, its functions and components.







## Left Panel



#	Icon	Item	Description
1		Optical drive	Houses an optical drive module (CD-ROM, DVD-ROM or DVD/CD-RW combo drive).
2		Optical drive indicator	Lights up when the optical drive is active.
3		Eject button	Ejects the drive tray.
4		Emergency eject slot	Ejects the drive tray when the computer is turned off. There is a mechanical eject button on the optical drive. Simply insert the tip of a pen or paperclip and push to eject the tray.

## Right Panel











#	Icon	Item	Description
1		Microphone/Line-in jack	Accepts audio line-in devices (e.g., microphone, audio CD player, stereo walkman).
2		Headphone/Speaker/Line-out jack	Connects to audio line-out devices (e.g., headphones, speakers).
3		PC card eject buttons	Eject the PC Card from the slot.
4		PC card slots	Accepts two Type II or one Typelll PC cards.
5		Modem jack	Connects to a phone line.
6		Network jack	Connects to an Ethernet 10/100-based network.
7		PS/2 port	Connects to a PS/2 keyboard or mouse.



## Rear Panel



#	Icon	Item	Description
1		Security keylock	Connects to a Kensington-compatible computer security lock.
2		Power jack	Connects to an AC adapter.
3		External display port	Connects to a display device (e.g., external monitor, LCD projector).
4		Parallel port	Connects to a parallel device (e.g., parallel printer).
5		Serial port	Connects to a serial device (e.g., serial mouse).
6		S-video	Connects to a television or display device with S-video input.
7		IEEE 1394 port	Connects to an IEEE 1394 device.
8		USB port	Connects to Universal Serial Bus devices (e.g., USB mouse, USB camera).

## Bottom Panel









#	Icon	Item	Description
1		Cooling fan	Helps keep the computer cool. Note: Don't cover or obstruct the opening of the fan.
2		Battery bay	Houses the computer's battery pack.
3		Battery release latches	Unlatches the battery to remove the battery pack.
4		Hard disk bay	Houses the computer's hard disk.
5		Memory compartment	Houses the computer's main memory.

## Indicators

The computer has seven easy-to-read status icons below the display screen.



The status LCD displays icons that show the status of the computer and its components.



Icon	Function	Description
	Power	Lights green when the computer is on and lights orange when the computer is in Standby mode.
	Media activity	Lights when the hard disk is active.
	Battery charge	Lights green when the battery is being charged. Lights orange when the battery power is low and is being charged.
	Wireless communication	Lights when the Wireless LAN capabilities are enabled.
	Caps lock	Lights when Caps Lock is activated.
	Num lock	Lights when Num Lock is activated.
	Scroll lock	Lights when Scroll Lock is activated.

---

## Lock Keys

The keyboard has three lock keys which you can toggle on and off.



Lock Key	Description
Caps Lock	When Caps Lock is on, all alphabetic characters typed are in uppercase.
Num lock (Fn-F11)	When Num Lock is on, the embedded keypad is in numeric mode. The keys function as a calculator (complete with the arithmetic operators +, -, *, and /). Use this mode when you need to do a lot of numeric data entry. A better solution would be to connect an external keypad.
Scroll lock (Fn-F12)	When Scroll Lock is on, the screen moves one line up or down when you press  and  respectively. Scroll Lock does not work with some applications.

# Embedded Numeric Keypad

The embedded numeric keypad functions like a desktop numeric keypad. It is indicated by small characters located on the upper right corner of the keycaps. To simplify the keyboard legend, cursor-control key symbols are not printed on the keys.



Desired Access	Num Lock On	Num Lock Off
Number keys on embedded keypad	Type numbers in a normal manner.	
Cursor-control keys on embedded keypad	Hold  while using cursor-control keys.	Hold Fn while using cursor-control keys.
Main keyboard keys	Hold Fn while typing letters on embedded keypad.	Type the letters in a normal manner.

---

## Windows Keys

The keyboard has two keys that perform Windows-specific functions.



Key	Icon	Description
Windows logo key		Start button. Combinations with this key perform special functions. Below are a few examples: <ul style="list-style-type: none"><li>+ Tab (Activates next taskbar button)</li><li>+ E (Explores My Computer)</li><li>+ F (Finds Document)</li><li>+ M (Minimizes All)</li><li> + Windows logo key + M (Undoes Minimize All)</li><li>+ R (Displays the Run... dialog box)</li></ul>
Application key		Opens a context menu (same as a right-click).

# Hot Keys







The computer uses hotkey or key combinations to access most of the computer's controls like sreen brightness, volume output.

To activate hot keys, press and hold the **Fn** key before pressing the other key in the hot key combination.



Hot Key	Icon	Function	Description
Fn-F1	?	Hot key help	Displays help on hot keys.
Fn-F2		System Property	Displays the System Property.
Fn-F3		Power Options	Display the Power Options Properties used by the computer (function available if supported by operating system). See "Power management" on page 25.
Fn-F4	Z <sup>2</sup>	Sleep	Puts the computer in Sleep mode. See "Power management" on page 25.
Fn-F5		Display toggle	Switches display output between the display screen, external monitor (if connected) and both the display screen and external monitor.
Fn-F6		Screen blank	Turns the display screen backlight off to save power. Press any key to return.
Fn-F7		Touchpad toggle	Turns the internal touchpad on and off.
Fn-F8		Speaker toggle	Turns the speakers on and off.
Fn-		Volume up	Increases the speaker volume.

---

Hot Key	Icon	Function	Description
Fn- 		Volume down	Decreases the speaker volume.
Fn- 		Brightness up	Increases the screen brightness.
Fn- 		Brightness down	Decreases the screen brightness



---

## The Euro Symbol

If your keyboard layout is set to United States-International or United Kingdom or if you have a keyboard with a European layout, you can type the Euro symbol on your keyboard.



**NOTE:** For US keyboard users: The keyboard layout is set when you first set up Windows. For the Euro symbol to work, the keyboard layout has to be set to United States-International.

To verify the keyboard type in Windows 2000, follow the steps below:

1. Click on **Start, Settings, Control Panel**.
2. Double-click on **Keyboard**.
3. Click on the **Language** tab.
4. Verify that keyboard layout used for "En English (United States)" is set to United States-International. If not, select and click on **Properties**; then select **United States-International** and click on **OK**.
5. Click on **OK**.

To verify the keyboard type in Windows XP, follow the steps below:

1. Click on **Start, Control Panel**.
2. Double-click on **Regional and Language Options**.
3. Click on the **Language** tab and click on **Details**.
4. Verify that the keyboard layout used for "En English (United States)" is set to United States-International. If not, select and click on **ADD**; then select **United States-International** and click on **OK**.
5. Click on **OK**.

To type the Euro symbol:

1. Locate the Euro symbol on your keyboard.
2. Open a text editor or word processor.
3. Hold **Alt Gr** and press the Euro symbol.

**NOTE:** Some fonts and software do not support the Euro symbol. Please refer to [www.microsoft.com/typography/faq/faq12.htm](http://www.microsoft.com/typography/faq/faq12.htm) for more information.

---

## Launch Keys

Located at the top of keyboard are five buttons. These buttons are called launch keys. They are designated as P1, P2, P3 Email button and Web browser button.



**NOTE:** To the left of these five launch keys is the wireless communication button. This wireless communication button works for model with 802.11b wireless LAN only.

Launch Key	Default application
P1	User-programmable
P2	User-programmable
P3	User-programmable
Email	Email application
Web browser	Internet browser application

---

## E-Mail Detection

Click right button at the Launch Manager icon on the taskbar and click on E-Mail Detection. In this dialog box, you have the option to enable/disable mail checking, set the time interval for mail checking, etc. If you already have an email account, you can fill in User Name, Password and POP3 Server in the dialog box. The POP3 Server is the mail server where you get your email.

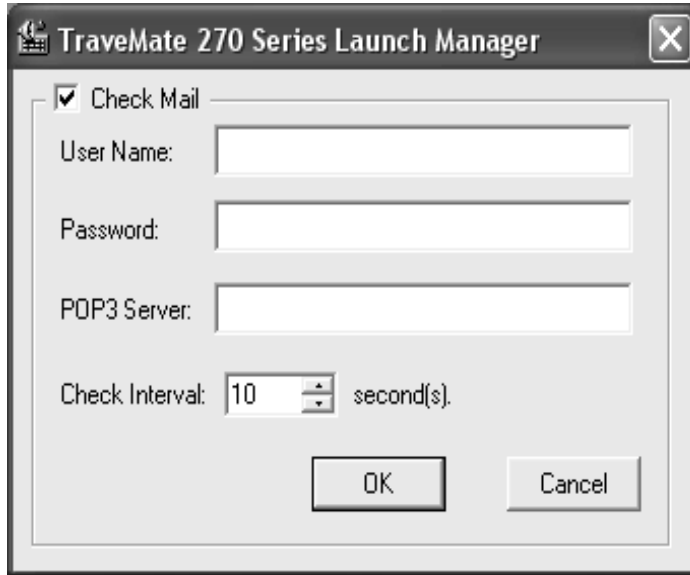

Aside from the email checking function, there is a mail button that is used to launch the email application. It is located above the keyboard right below the LCD.

# Touchpad

The built-in touchpad is a pointing device that senses movement on its surface. This means the cursor responds as you move your finger on the surface of the touchpad. The central location on the palmrest provides optimal comfort and support.



**NOTE:** If you are using an external USB mouse, you can press **Fn-F7** to disable the touchpad.

## Touchpad Basics

The following teaches you how to use the touchpad:



- Move your finger across the touchpad to move the cursor.
- Press the left (1) and right (3) buttons located on the edge of the touchpad to do selection and execution functions. These two buttons are similar to the left and right buttons on a mouse. Tapping on the touchpad produces similar results.
- Use the 4-way scroll (2) button (top/bottom/left/and right) to scroll.

Function	Left Button	Right Button	Scroll Button	Tap
Execute	Click twice quickly			Tap twice (at the same speed as double-clicking the mouse button)
Select	Click once			Tap once
Drag	Click and hold, then use finger to drag the cursor on the touchpad			Tap twice (at the same speed as double-clicking a mouse button) then hold finger to the touchpad on the second tap to drag the cursor
Access context menu		Click once		

---

Function	Left Button	Right Button	Scroll Button	Tap
Scroll			Click and hold the button in the desired direction (up/down/left/right)	

**NOTE:** Keep your fingers dry and clean when using the touchpad. Also keep the touchpad dry and clean. The touchpad is sensitive to finger movements. Hence, the lighter the touch, the better the response. Tapping too hard will not increase the touchpad's responsiveness.

# Hardware Specifications and Configurations

## Processor

Item	Specification
CPU type	Intel Pentium 4
CPU package	/μ FC-PGA package
CPU core voltage	1.3/1.2

## BIOS

Item	Specification
BIOS vendor	Phoenix
BIOS Version	1.00
BIOS ROM type	Flash ROM
BIOS ROM size	512KB
BIOS package	TSOP
Supported protocols	ACPI 1.0b, PC Card 95, SM BIOS 2.3, EPP/IEEE 1284, ECP/IEEE 1284 1.7 & 1.9, PCI 2.2, PnP 1.0a, DMI 2.0, PS/2 keyboard and mouse, USB, VGA BIOS, CD-ROM bootable,
BIOS password control	Set by setup manual

## Second Level Cache

Item	Specification
Cache controller	Built-in CPU
Cache size	512KB
1st level cache control	Always enabled
2st level cache control	Always enabled
Cache scheme control	Fixed in write-back

## System Memory

Item	Specification
Memory controller	
Memory size	128/256MB
DIMM socket number	1 sockets (2 banks)
Supports memory size per socket	512MB
Supports maximum memory size	1G (by two 512MB SO-DIMM module)
Supports DIMM type	DDR Synchronous DRAM
Supports DIMM Speed	133 MHz
Supports DIMM voltage	2.5V
Supports DIMM package	200-pin soDIMM
Memory module combinations	You can install memory modules in any combinations as long as they match the above specifications.

### Memory Combinations

Slot 1	Slot 2	Total Memory
128MB/256 MB	0 MB	128MB/256 MB
128MB/256 MB	128 MB	256MB/384 MB
128MB/256 MB	256 MB	384MB/512 MB
128MB/256 MB	512 MB	640MB/768 MB
512MB	512MB	1024MB

**NOTE:** Above table lists some system memory configurations. You may combine DIMMs with various capacities to form other combinations. .

### LAN Interface

Item	Specification
Supports LAN protocol	10/100 Mbps
LAN connector type	RJ45
LAN connector location	Right side

### Modem Interface

Item	Specification
Data modem data baud rate (bps)	56K
Supports modem protocol	V.90 MDC
Modem connector type	RJ11
Modem connector location	Right side

### Floppy Disk Drive Interface

Item	Specification		
Vendor & model name	Panasonic JU226A273FC/Mitsumi D353G-2938		
Floppy Disk Specifications			
Media recognition	2DD (720KB)	2HD (1.2MB, 3-mode)	2HD (1.44MB)
Sectors/track	9	15	18
Tracks	80	80	80
Rotational speed (RPM)	300	360	300
Read/write heads	2		
Encoding method	MFM/FM		
Power Requirement			
Input Voltage (V)	+5V +/- 10%		

### Hard Disk Drive Interface

Item	Specification								
Vendor & Model Name	IBM 20G	IBM 30G	IBM 40G	Toshiba 20G (MK2018 )	Toshiba 30G (MK3018 )	Toshiba 40G (MK4018 )	Hitachi 20G DK23DA -20F	Hitachi 30G DK23DA -30F	Hitachi 40G DK23DA -40F
Capacity (MB)	20000	30000	40000	20000	30000	40000	20000	30000	40000
Bytes per sector	512	512	512	512	512	512	512	512	512
Data heads	2	3	4	2	3	4	2	3	4
Drive Format									
Disks	1	2	2	1	2	2	1	2	2

### Hard Disk Drive Interface

Item	Specification								
Spindle speed (RPM)	4200 RPM	4200 RPM	4200 RPM	4200 RPM	4200 RPM	4200 RPM	4200 RPM	4200 RPM	4200 RPM
Performance Specifications									
Buffer size	2048KB	2048KB		2048KB	2048KB				
Interface	ATA-5	ATA-5		ATA-5	ATA-5				
Max. media transfer rate (disk-buffer, Mbytes/s)	216	287		287	235				
Data transfer rate (host-buffer, Mbytes/s)	100 MB/Sec. Ultra DMA mode-5	100 MB/Sec. Ultra DMA mode-5		100 MB/Sec. Ultra DMA mode-5	100 MB/Sec. Ultra DMA mode-5				
DC Power Requirements									
Voltage tolerance	5V(DC) +/- 5%	5V(DC) +/- 5%		5V(DC) +/- 5%	5V(DC) +/- 5%				

### DVD-ROM Interface

Item	Specification	
Vendor & model name	Toshiba SD-C2502	
Performance Specification	With CD Diskette	With DVD Diskette
Transfer rate (KB/sec)	Sustained: Max 3.6Mbytes/sec	Sustained: Max 10.8Mbytes/sec
Data Buffer Capacity	128 KBytes	
Interface	IDE/ATAPI	
Applicable disc format	DVD: DVD-ROM (DVD-5, DVD-9, DVD-10, DVD-18), DVD-R (read, single border) CD: CD-DA, CD+(E)G, CD-MIDI, CD-TEXT, CD-ROM, CD-ROM XA, CD-I, CD-I Bridge (Photo-CD, Video-CD) Multisession CD (Photo-CD, CD-EXTRA, CD-R, CD-RW), CD-R (read), CD-RW (read)	
Loading mechanism	Load: Manual Release: (a) Electrical Release (Release Button) (b) Release by ATAPI command (c) Emergency Release	
Power Requirement		
Input Voltage	+5 V +/- 5 % (Operating) +/- 8 % (Start up)	



## Audio Interface

Item	Specification
Audio Controller	Integrated Software Audio in SiS961 South Bridge with Realtek ALC202 AC97 Codec(No SPDIF)
Audio onboard or optional	Built-in
Mono or Stereo	Stereo
Resolution	20 bit stereo Digital to analog converter 18 bit stereo Analog to Digital converter
Compatibility	Microsoft PC98/PC99, AC97 2.1
Mixed sound source	Line-in, CD, Video, AUX
Voice channel	8/16-bit, mono/stereo
Sampling rate	44.1 KHz
Internal microphone	No
Internal speaker / Quantity	Yes/2
Supports PnP DMA channel	DMA channel 00
Supports PnP IRQ	IRQ3, IRQ5, IRQ7, IRQ9, IRQ10, IRQ11

## Video Interface

Item	Specification
Chip vendor	SiS
Chip name	Integrated VGA chip in SiS650 North Bridge
Chip voltage	Core/3.3V
Supports ZV (Zoomed Video) port	No

## Video Resolutions Mode (for both LCD and CRT)

Resolution	16 bits (High color)	32 bits (True color)
800x600	Yes	Yes
1024x768	Yes	Yes
1152x864	Yes	Yes
1280x1024	Yes	Yes
1400x1050 (SXGA+panel only)	Yes	Yes

## Parallel Port

Item	Specification
Parallel port controller	SMSC LPC47N227
Number of parallel port	1
Location	Rear side
Connector type	25-pin D-type connector, in female type
Parallel port function control	Enable/Disable/Auto (BIOS or operating system chooses configuration) by BIOS Setup <b>Note:</b> Depending on your operating system, disabling an unused device may help free system resources for other devices.

## Parallel Port

Item	Specification
Supports ECP/EPP/Bi-directional (PS/2 compatible)	Yes (set by BIOS setup) <b>Note:</b> When Mode is selected as EPP mode, "3BCh" will not be available.
Optional ECP DMA channel (in BIOS Setup)	DMA channel 1
Optional parallel port I/O address (in BIOS Setup)	378h, 278h, 3BCH
Optional parallel port IRQ (in BIOS Setup)	IRQ7, IRQ5

## USB Port

Item	Specification
USB Compliancy Level	1.1
OHCI	USB 1.1
Number of USB port	3
Location	Rear side
Serial port function control	Enable/Disable by BIOS Setup

## PCMCIA Port

Item	Specification
PCMCIA controller	ENE CB1420 CardBus controller
Supports card type	Type-III/II
Number of slots	One type-III or Two type-II
Access location	Right panel
Supports ZV (Zoomed Video) port	No ZV support
Supports 32 bit CardBus	Yes (IRQ11)

## System Board Major Chips

Item	Controller
System core logic	SiS650+SiS961(SB)
Super I/O controller	SMC LPC47N227
Audio controller	Integrated Software Audio in SiS961 South Bridge with Realtek ALC202 AC97 Codec(No SPDIF)
Video controller	Integrated VGA chip in SiS650 North Birdge
Hard disk drive controller	ICH2
Keyboard controller	NS87591
RTC	ICH2

## Keyboard

Item	Specification
Keyboard controller	NS87591
Keyboard vendor & model name	Chicony
Total number of keypads	87/88/89 keys with 101/102 key emulation
Windows logo key	Yes
Internal & external keyboard work simultaneously	Yes

## Battery

Item	Specification
Vendor & model name	Panasonic
Battery Type	Li-ion
Pack capacity	57Wh
Cell voltage	3.7V/cell
Number of battery cell	8
Package configuration	4 cells in series, 2 series in parallel
Package voltage	14.8V

## LCD Inverter Specification

This inverter is designed to light up the CCFL of LCD for TravelMate 270 series notebook. It should be supported the following LCD panels.

No.	Supplier	Model	Type
1	LG	LP150x04	TFT, 15.0" XGA
2	Hitachi	TX38D85	TFT, 15.0" XGA
3	CPT	CLAA14/XF01	TFT, 14.1" XGA
4	CPT	CLAA150PA01	TFT, 15.0" SXGA+
5	LG	LP150E0/-A2M2	TFT, 15.0" SXGA+
6	IBM	ITSX95C	TFT 15.0" XGA

There are two control signals that come from system to control lamp brightness. One signal is named DAC\_BRIG, which limits current to meet LCD lamp current specification. Another one is named PWM, which adjusts lamp brightness. This inverter brightness is adjusted by PWM burst mode. The PWM burst mode is that turning on and off the lamp at rate of 150Hz. The effective brightness is a function of the duty cycle.

## Features

1. Wide range 9V to 21V input voltage.
2. Brightness adjustment by PWM duty mode.

### 3. Automatic brightness compensation for input voltage variation.

#### Electrical Characteristics

No.	Parameter	Symbol	Min.	Typ.	Max.	Unit	Comment
1	Input voltage	NV_PWR	9	14.8	21	V	
2	Input current	Iin	--	0.33	--	A	
3	Lamp current	IL	2.7	--	6.3	mA	*Note 1
4	Frequency	F	45	55	65	KHz	* Note 2
5	Output power	Pout	--	--	4.5	W	
6	Efficiency	η	80%	--	--	--	
7	Starting voltage	Vs	1600	--	---	V	At 0°C
8	Starting time	Tvs	1	--	1.5	Sec	
9	DispoFF#		2.8	3.3	3.6	V	Backlight on/off signal
			0	0.5	0.8	V	Low level
10	Limited lamp maximum current	DAC-BRIG	0		3.3	V	*Note 1
11	PWM signal *Note 4	INV_PWM	142	150	158	Hz	PWM signal frequency
			3.0	3.3	3.6	V	PWM signal amplitude
			30	--	100	%	Duty = $\frac{T_{on}}{Period}$
12	Lamp current over-shoot	I zero-PK	--	--	10	%	Line transient (10.8V to 21V/100us) and turn on transient
13	Current Waveform factor	$\frac{I_p}{I_{rms}}$	1.27	$\sqrt{2}$	1.56	Multiple	$\frac{I_{-p}}{I_{rms}}$ or $I_{rms} * 10$
14	Unbalance Rate	$\frac{I_p -  I_{-p} }{I_{rms}}$	-10%	0	+10%	Muiltple	
15	Turn off voltage	Voff	--	--	100Vp-P	V	PWM=40%
16	Voltage Rise time	Trise	--	--	300us	us	PWM=40%
17	Voltage fall time	Tfall	--	--	300us	us	PWM=40%

**NOTE:** Please pay attention to the following:

\*1. Limited lamp maximum current by DAC\_BRIG signal:

When DAC\_BRIG voltage is 0V and INV\_PWM enables (100%), lamp has max. current.

When DAC\_BRIG voltage is 3.3V and INV\_PWM enables (100%), lamp has min. current.

DAC\_BRIG signal comes from system chipset with internal resistance of 3K  $\Omega$

\*2. Inverter operating frequency should be within specification (45~65kHz) at max. and min. brightness load.

\*3. INV\_PWM enable implies INV\_PWM signal is High level (On duty cycle is 100%). It is a square wave of 150Hz to adjust backlight brightness that is a function of PWM duty cycle. Backlight brightness is maximum value under INV\_PWM at 100% and brightness is minimum under INV\_PWM at 30%.

\*4. The system interface signals belong to 3.3V.

\*5. Please make sure open lamp output voltage should be within starting voltage specification.

\*6. Inverter should pass human body safety test.

\*7. Inverter should be no smoking by any component open/short test.

\*8. Transformer voltage stress should not be over 85% under any condition.

(turn on overshoot transient and line transient.)

\*9. Audio noise should be less than 36dB at 10cm distance.

### Electrical specification

No	Symbol	Min.	Typ.	Max.	Unit	Comment
1	V oper*	--	700	--	Vrms	Lamp operating voltage
	II	5.7	6.0	6.3	mArms	DAC_BRIG: 0V, PWM:100%
	II	2.7	3.0	3.3	mArms	DAC_BRIG: 0V, PWM:30%
	F	45	55	65	kHz	
	$\eta$	80%	--	--	--	

### Thermal

All components on inverter board should follow below rules:

1. Component using conditions (component stress) must be within component specification including voltage rating, current rating, temperature etc.

2. Component temperature should follow below:

$\Delta T \leq 30$  degree C, at 25, 35 degree C.

Component temperature should be less than 70 degree C inside system at 35 degree C.

### LCD

Item	Specification				
Vendor & model name	AU UB 141X03	Samsung LTN141XF-L05	Hannstar HSD150PXII-B	Hannstar HSD150PKII-B	IBM ITUX97C
Mechanical Specifications					
LCD display area (diagonal, inch)	14.1	14.1	15.0	15.0	15.0
Display technology	TFT	TFT	TFT	TFT	TFT
Resolution	XGA (1024x768)	XGA (1024x768)	XGA (1024x768)	SXGA+ (1400x1050)	UXGA (1600x1200)

## LCD

Item	Specification				
Supports colors	262K	262K	262K	262K	262K
Optical Specification					
Brightness control	keyboard hotkey	keyboard hotkey	keyboard hotkey	keyboard hotkey	keyboard hotkey
Contrast control	No	No	No	No	No
Suspend/Standby control	Yes	Yes	Yes	Yes	Yes
Electrical Specification					
Supply voltage for LCD display (V)	3.3	3.3	3.3	3.3	3.3
Supply voltage for LCD backlight (Vrms)	690	690	690	690	690

## AC Adapter

Item	Specification
Vendor & model name	ADAPTER ADP-65DB BG65W 3 PINS
Input Requirements	
Maximum input current (A, @90Vac, full load)	1.8 A @ 90Vac 0.9 A @ 180Vac
Nominal frequency (Hz)	47 - 63
Frequency variation range (Hz)	47 - 63
Nominal voltages (Vrms)	90 - 265
Inrush current	The maximum inrush current will be less than 50A and 100A when the adapter is connected to 115Vac(60Hz) and 230Vac(50Hz) respectively.
Efficiency	It should provide an efficiency of 84% minimum, when measured at maximum load under 115V(60Hz).
Output Ratings (CV mode)	
DC output voltage	19.0V including the effects of line voltage variation, load current, ripple and noise
Noise + Ripple	300mvp-pmax (20MHz bandwidth) for resistor load
Output current	0 A (min.) 3.5A (max.)
Output Ratings (CC mode)	
DC output voltage	19.0
Constant output	3.5A
Dynamic Output Characteristics	
Start-up time	3 sec. (@115Vac)
Hold up time	6 ms min. (@120 Vac input, full load)
Over Voltage Protection (OVP)	25 V
Short circuit protection	Output can be shorted without damage, and auto recovery
Electrostatic discharge (ESD)	15kV (at air discharge) 8kV (at contact discharge)
Dielectric Withstand Voltage	
Primary to secondary	4242 Vdc for 1 second
Leakage current	60uA at 254Vac
Regulatory Requirements	1. FCC class B requirements(USA) 2. VDE class B requirements(German) 3. VCCI classII requirements(Japan)

ACPI mode	Power Management
Mech. Off (G3)	All devices in the system are turned off completely.
Soft Off (G2/S5)	OS initiated shutdown. All devices in the system are turned off completely.
Working (G0/S0)	Individual devices such as the CPU and hard disk may be power managed in this state.
Standby (S1)	CPU in Stop Clock state VGA Standby, turn off back-light PCMCIA Standby Audio Power Down Hard Disk Spin Down motor Super I/O Power down
Suspend to RAM (S3)	CPU set power down VGA Suspend PCMCIA Suspend Audio Power Down Hard Disk Power Down CD-ROM Power Down Super I/O Low Power mode
Save to Disk (S4)	Also called Hibernate state. System saves all system states and data onto the disk prior to power off the whole system.

### Environmental Requirements

Item	Specification
Temperature	
Operating	+5~+35°C
Non-operating	-20~+50°C
Non-operating	-20~+50°C (storage package)
Humidity	
Operating	10% to 90% RH, non-condensing
Non-operating	10% to 90% RH, non-condensing (unpacked)
Non-operating	10% to 90% RH, non-condensing (storage package)
Vibration	
Operating (unpacked)	5~500Hz: 1.0G
Non-operating (unpacked)	50~500Hz: 2.16G

### Mechanical Specification

Item	Specification
Dimensions	322mm (W) x 272mm (D) x 38.0 mm(H) for 14.1 LCD model 327mm (W) x 272mm (D) x 38.5mm (H) for 15.0 inch model
Weight	6.71lb~7.2lb (including HDD, CD-ROM, FDD and BATT) for 14.1 inch model 6.78lb ~7.5lb(including HDD, CD-ROM, FDD and BATT) for 15.0 inch model
I/O Ports	1 parallel port (25 pins) EPP/ECP capability, 1 CRT port (15 pins) supports DDC 2B, 1 TV-out connector, 1 microphone-in port, 1 headphone-out with SPDIF port, 1 AC adapter jack (2 pins), 1 type III or type II PCMCIA card bus slots, 3 USB ports (4 pins), 1 RJ-11/RJ-45 port
Drive Bays	One
Material	Plastic PC+ABS (Bayer OM105Q)
Indicators	Power, Media activity, Battery charge, Wireless communication, Caps lock, Num lock and Scroll lock indicators

## Mechanical Specification

Item	Specification
Switch	Power switch Lid switch Internet switch Wireless ON/OFF switch E-mail switch

## Memory Address Map

Memory Address	Size	Function
00100000h-000F0000h	64KB	System BIOS
000CD000h-000C0000h		VGA BIOS
000C0000h-000A0000h	128 KB	Video memory (VRAM)
000A0000h-00000000h	640KB	Conventional memory

## I/O Address Map

I/O Address	Function
000-00F	DMA controller-1
020-021	Interrupt controller-1
040-043	Timer 1
060, 064	Keyboard controller 38859 chip select
061	System speaker out
040B	DMA controller-1
061	System speaker
070-071	Real-time clock and NMI mask
080-08F	DMA page register
0A0-0A1	Interrupt controller-2
0C0-0DF	DMA controller-2
0F0-0FF	Numeric data processor
170-177	2nd EIDE device (CD-ROM) select
1F0-1F7	1st EIDE device (hard drive) select
220-22F	Audio
240-24F	Audio (optional)
278-27F	Parallel port 3
378,37A	Parallel port 1
3B0-3BB 3C0-3DF	Video Controller
3F0h-3F7	Standard Floppy Disk Controller
3F0-3F7	Floppy disk controller
480-48F, 4D6	DMA controller-1
4D0-4D1 CF8-CFF	PCI configuration register

## IRQ Assignment Map

Interrupt Channel	Function(Hardware)
IRQ00	System timer
IRQ01	Keyboard
IRQ02	Programmable Interrupt Controller
IRQ03	Free by default or Generic



---

### IRQ Assignment Map

Interrupt Channel	Function(Hardware)
IRQ04	Communications Port (COM1)
IRQ05	PCI AUDIO/MODEM
IRQ06	Standard Floppy Disk Controller
IRQ07	ECP Printer Port (LPT1)
IRQ08	Real Time Clock
IRQ09	SCI
IRQ10	LAN/Universal Serial Bus
IRQ11	PCMCIA/VGA
IRQ12	Mouse
IRQ13	Numeric data processor
IRQ14	Primary IDE controller (hard disk)
IRQ15	Secondary IDE controller (CD-ROM drive)

### DMA Channel Assignment

DMA Channel	Function(Hardware)
00	PnP Audio System CODEC
01	Free
02	Standard Floppy Disk Controller
03	ECP Printer Port (default)

## System Utilities

### BIOS Setup Utility

The BIOS Setup Utility is a hardware configuration program built into your computer's BIOS (Basic Input/Output System).

Your computer is already properly configured and optimized, and you do not need to run this utility. However, if you encounter configuration problems, you may need to run Setup. Please also refer to Chapter 4 Troubleshooting when problem arises.

To activate the BIOS Utility, press **F2** during POST (when "Press <F2> to enter Setup" message is prompted on the bottom of screen).

PhoenixBIOS Setup Utility					
Main	System Devices	Security	Boot	Info.	Exit
Item specific Help					
System Time:		[09:00:00]			
System Date:		[01/01/2002]	<Tab>, <Shift-Tab>, or		
Floppy Disk Drive		1.44 MB	Floppy disk size		
Internal Hard Disk:		[ xxxxx MB]	Disk Size		
ATAPI Device :		[ Model Name]			
Boot Display Device:		[Both]			
Screen Expansion:		[Enabled]			
Television Type:		[NTSC]	Select NTSL or PAL standard		
VGA Memory:		[32MB]	VGA Memory Size Configuration		
F1 Help    ↑↓ Select Item    F5/F6 Change Values    F9 Setup defaults Esc Exit    ←→ Select Menu    Enter Select ▶ Sub-Menu    F10 Save and Exit					

### Navigating the BIOS Utility

There are six menu options: Main, System Devices, Security, Boot, Info. and Exit.

Follow these instructions:

- To choose a menu, use the cursor left/right keys (← →).
- To choose a parameter, use the cursor up/down keys (↑ ↓).
- To change the value of a parameter, press **F5** or **F6**.
- A plus sign (+) indicates the item has sub-items. Press **ENTER** to expand this item.
- Press **ESC** while you are in any of the menu options to go to the Exit menu.
- In any menu, you can load default settings by pressing **F9**. You can also press **F10** to save any

---

changes made and exit the BIOS Setup Utility.

**NOTE:** You can change the value of a parameter if it is enclosed in square brackets. Navigation keys for a particular menu are shown on the bottom of the screen. Help for parameters are found in the Item Specific Help part of the screen. Read this carefully when making changes to parameter values.

## Main

The Main screen displays a summary of your computer hardware information, and also includes basic setup parameters. It allows the user to specify standard IBM PC AT system parameters.

PhoenixBIOS Setup Utility				
Main	System Devices	Security	Boot	Info. Exit
Item specific Help				
System Time:		[09:00:00]		
System Date:		[01/01/2002]	<Tab>, <Shift-Tab>, or	
Floppy Disk Drive		1.44 MB		Floppy disk size
Internal Hard Disk:		[xxxxx MB]		Disk Size
ATAPI Device :		[ Model Name]		
Boot Display Device:		[Both]		
Screen Expansion:		[Enabled]		
Television Type:		[NTSC]		Select NTSL or PAL standard
VGA Memory:		[32MB]		VGA Memory Size Configuration
F1 Help	↑↓ Select Item	F5/F6 Change Values	F9 Setup defaults	
Esc Exit	←→ Select Menu	Enter Select	Sub-Menu	F10 Save and Exit

**NOTE:** The screen above is for reference only. Actual values may differ.

The table below describes the parameters in this screen. Settings in **boldface** are the default and suggested parameter settings..

Parameter	Description	Format/Option
System Time	Sets the system time.	Format: HH:MM:SS (hour:minute:second)System Time
System Date	Sets the system date.	Format MM/DD/YYYY (month/day/ year) System Date
Floppy Disk Drive	Shows floppy drive type information.	
Internal Hard Disk	Shows the hard disk types and capacity. If there is no hard disk present or unknown type, "None" should be shown on this field, otherwise the capacity must be shown.	
ATAPI Device	Auto detects and shows the CD-ROM, DVD-ROM or CD-RW types. If there is no ATAPI Device present or unknown type, "None" should be shown on this field, otherwise the model name must be shown.	
Boot Display Device	Both: Simultaneously enable both the integrated LCD screen and the system's external video port (for an external CRT or projector). Auto-Selected: During power on process, the system will detect if any display device is connected on external video port. If any external display device is connected, the power on display will be in CRT (or projector) only mode. Otherwise it will be in LCD only mode.	Option: <b>Both</b> or Auto-Selected
Screen Expansion		Option: <b>Enabled</b> or Disabled
Television Type	Selects NTSC or PAL standard.	Option: <b>NTSC</b> or PAL
VGA Memory	Specifies the amount of main memory to allocate for VGA.	Option: <b>32MB</b> /16MB/64MB

**NOTE:** The sub-items under each device will not be shown if the device control is set to disable or auto. This is because the user is not allowed to control the settings in these cases.

## System Devices

The System Devices screen contains parameters involving your hardware devices. It also provides advanced settings of the system.

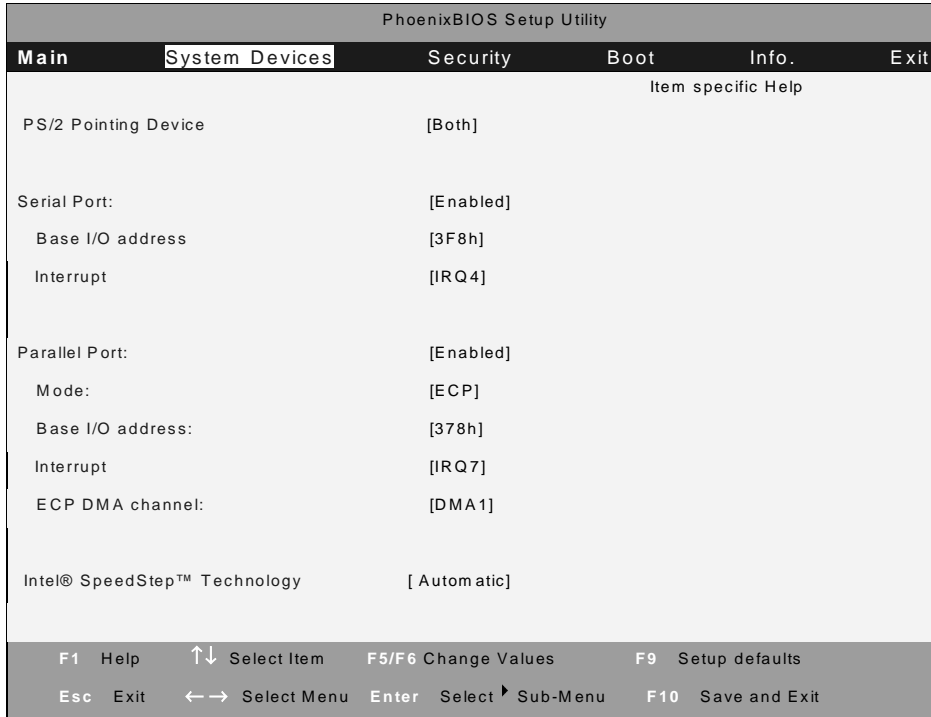

The table below describes the parameters in the screen. Settings in **boldface** are the default and suggested parameter settings.

Parameter	Description	Options
PS/2 Pointing Device	Determines whether or not to disable the internal touchpad of a PS/2 pointing device is connected.	<b>Both</b> or Auto-Selected
Serial Port	Enables, disables or auto detects the serial port.	<b>Enabled</b> /Disabled/Auto
Base I/O address	Sets the I/O address of the serial port.	<b>3F8h</b> /2F8h/3E8h/2E8h
Interrupt	Sets the interrupt request of the serial port.	<b>IRQ4</b> / IRQ3
Parallel Port	Enables, disables or auto detects the parallel port.	<b>Enabled</b> /Disabled/Auto
Mode	Sets the operation mode of the parallel port.	<b>ECP</b> , EPP, Normal or Bi-directional
Base I/O address	Sets the I/O address of the parallel port. This parameter is enabled only if Mode is set to ECP or Bi-directional.	<b>378h</b> , 278h or 3BCh
Interrupt	Sets the interrupt request of the parallel port.	<b>IRQ 7</b> or IRQ5
Mode	Sets the operation mode of the parallel port.	<b>ECP</b> , EPP or Bi-directional
ECP DMA Channel	Sets a DMA channel for the printer to operate in ECP mode. This parameter is enabled only if Mode is set to ECP.	<b>DMA3</b> or DMA1

## Security

The Security screen contains parameters that help safeguard and protect your computer from unauthorized use.

PhoenixBIOS Setup Utility				
Main	System Devices	Security	Boot	Info.
Exit				Item specific Help
	User Password is	Clear		
	Administrator Password is	Clear		
	Set User Password	[Enter]		
	Set Administrator Password	[Enter]		Supervisor Password controls access to the setup utility
	Password Required to:			
	Boot:	[Enabled]		
	Processor Serial Number :	[Enabled]		
F1 Help	↑↓ Select Item	F5/F6 Change Values	F9 Setup defaults	
Esc Exit	←→ Select Menu	Enter Select ▶ Sub-Menu	F10 Save and Exit	



The table below describes the parameters in this screen. Settings in **boldface** are the default and suggested parameter settings.

Parameter	Description	Option
User Password is	Shows the setting of the user password.	<b>Clear</b> or Set
Administrator Password is	Shows the setting of the administrator password	<b>Clear</b> or Set
Set User Password	Press Enter to set the user password. When set, this password protects the BIOS Setup Utility from unauthorized access.	
Set Administrator Password	Press Enter to set the administrator password. When set, this password protects the BIOS Setup Utility from unauthorized access.	
Password require to	Defines whether a password is required or not while the events defined in this group happened. The following sub-options are all requires the Administrator password for changes and should be grayed out if the user password was used to enter setup.m (When enabled, the user password protects the computer from unauthorized access during boot up.)	<b>Disabled</b> or Enabled
Boot	Allows the user to specify whether or not a password is required to boot.	<b>Disabled</b> or Enabled

**NOTE:** When you are prompted to enter a password, you have three tries before the system halts. Don't forget your password. If you forget your password, you may have to return your notebook computer to your dealer to reset it.

## Setting a Password

Follow these steps as you set the user or the administrator password:

- Use the  and  keys to highlight the Set Administrator Password parameter and press the  key. The Set Administrator Password box appears:



Set Administrator Password

Enter New Password [            ]

Confirm New Password [            ]



- Type a password in the Enter new password field. The password length can not exceeds 8 alphanumeric characters (A-Z, a-z, 0-9, not case sensitive). Retype the password in the Confirm new password field.

**IMPORTANT:** Be very careful when typing your password because the characters do not appear on the screen.

- Press .
- After setting the password, the computer sets the User Password parameter to "Set".
- If desired, you can opt to enable the Password on boot parameter.
- When you are done, press  to save the changes and exit the BIOS Setup Utility.

## Removing a Password

Follow these steps:

- Use the  and  keys to highlight the Set User Password parameter and press the  key. The Set Password box appears:



Set Administrator Password	
Enter current password	[            ]
Enter New Password	[            ]
Confirm New Password	[            ]

2. Type the current password in the Enter Current Password field and press **ENTER**.
3. Press **ENTER** twice **without** typing anything in the Enter New Password and Confirm New Password fields. The computer then sets the Administrator Password parameter to "Clear".
4. When you have changed the settings, press **F10** to save the changes and exit the BIOS Setup Utility.

### Changing a Password

1. Use the **↑** and **↓** keys to highlight the Set User Password parameter and press the **ENTER** key. The Set Password box appears:

Set Administrator Password	
Enter current password	[            ]
Enter New Password	[            ]
Confirm New Password	[            ]

2. Type the current password in the Enter Current Password field and press **ENTER**.
3. Type a password in the Enter New Password field. Retype the password in the Confirm New Password field.
4. Press **ENTER**. After setting the password, the computer sets the User Password parameter to "Set".
5. If desired, you can enable the Password on boot parameter.
6. When you are done, press **F10** to save the changes and exit the BIOS Setup Utility.

If the verification is OK, the screen will display as following.

Setup Notice
Changes have been saved.
[ continue ]

The password setting is complete after the user presses **F10**.

If the current password entered does not match the actual current password, the screen will show you the Setup Warning.

---

Setup Warning  
Invalid password  
Re-enter Password  
[ continue]

If the new password and confirm new password strings do not match, the screen will display the following message.

Setup Warning  
Password do not match  
Re-enter Password

# Boot

This menu allows the user to decide the order of boot devices to load the operating system. Bootable devices includes the distette drive in module bay, the onboard hard disk drive and the CD-ROM in module bay.

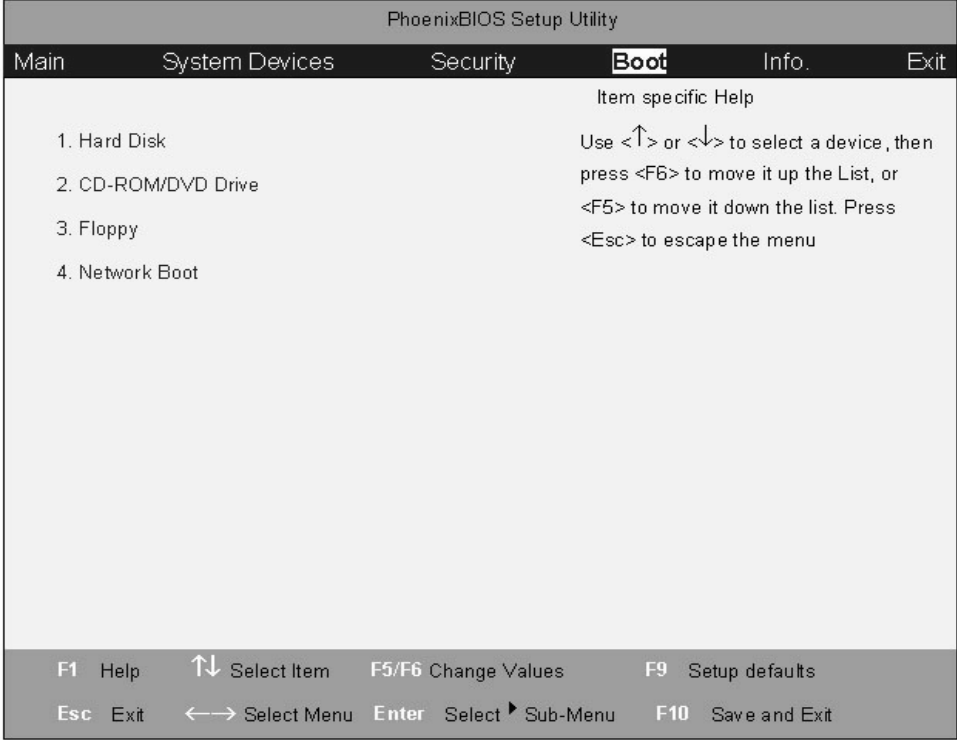

# Info.

This menu provides you the information of the system.

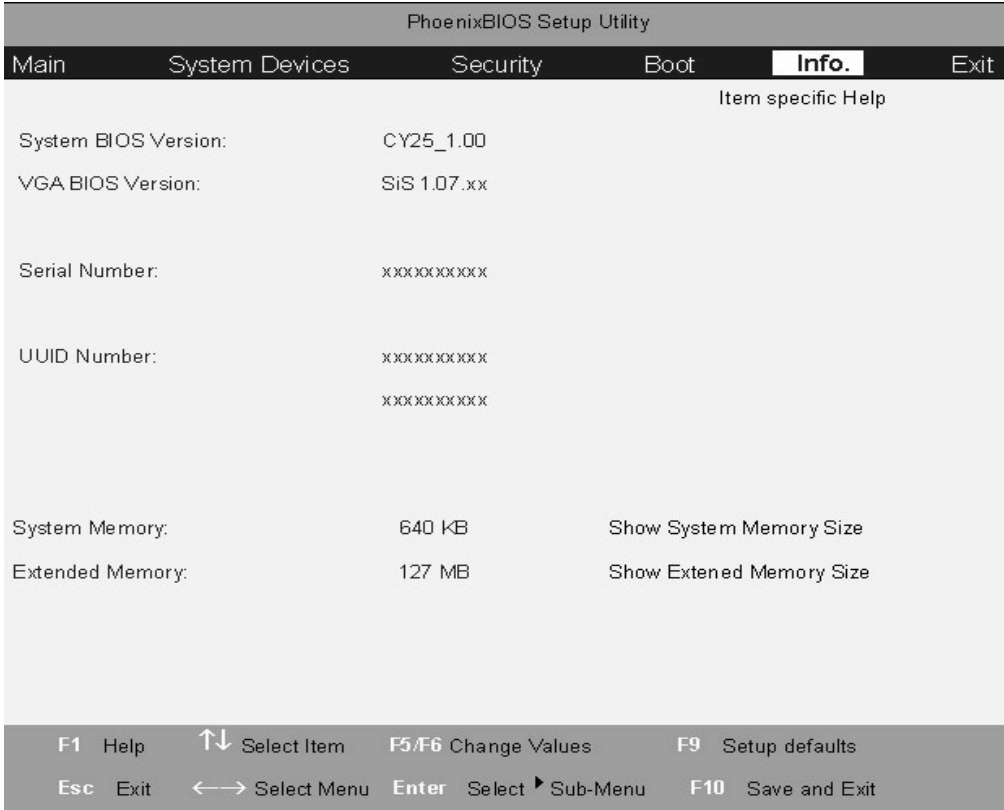

Parameter	Description
System BIOS Version	Displays system BIOS version
VGA BIOS Version	Displays VGA BIOS version
Serial Number	
UUID Number	UUID=16bytes
System Memory	This field reports the memory size of system base memory. The size is fixed to 640KB.
Extended Memory	This field reports the memory size of the extended memory in the system. Extended memory size=Total memory size-1MB

# Exit

The Exit screen contains parameters that help safeguard and protect your computer from unauthorized use.

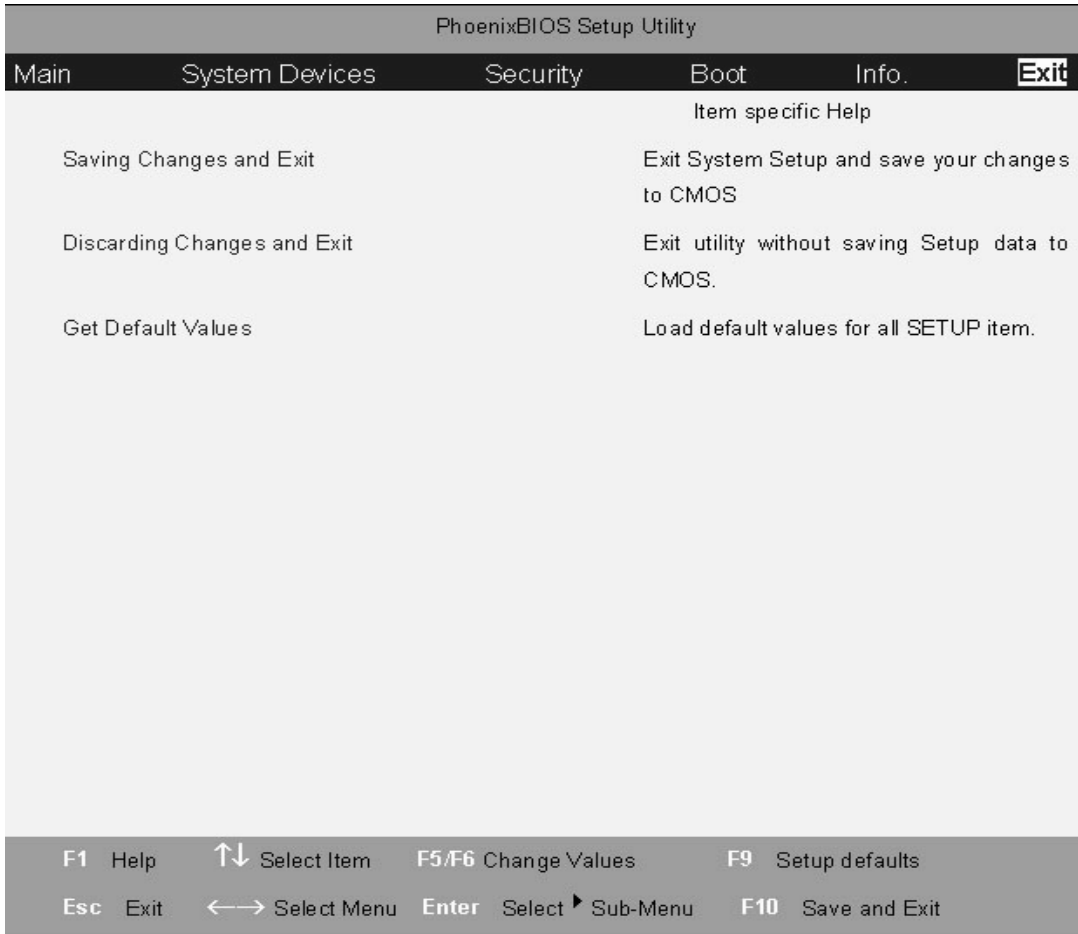

The table below describes the parameters in this screen.

Parameter	Description
Saving Changes and Exit	Saves your changes to CMOS and exits System Setup (same as  ).
Discarding Changes and Exit	Discards changes made and exits System Setup.
Get Default Values	Loads default settings for all parameters (same as  ).

---

## BIOS Flash Utility

The BIOS flash memory update is required for the following conditions:

- New versions of system programs
- New features or options
- Restore a BIOS when it becomes corrupted.

Use the Phlash utility to update the system BIOS flash ROM.

**NOTE:** If you do not have a crisis recovery diskette at hand, then you should create a **Crisis Recovery Diskette** before you use the Phlash utility.

**NOTE:** Do not install memory-related drivers (XMS, EMS, DPMS) when you use the Phlash.

**NOTE:** Please use the AC adaptor power supply when you run the Phlash utility. If the battery pack does not contain enough power to finish BIOS flash, you may not boot the system because the BIOS is not completely loaded.

Follow the steps below to run the Phlash.

1. Prepare a bootable diskette.
2. Copy the Phlash utilities to the bootable diskette.
3. Then boot the system from the bootable diskette. The Phlash utility has auto-execution function.

## System Utility Diskette

This utility diskette is for the Acer TravelMate 270 series notebook machine. You can find the utility in Service CD kit. It provides the following functions:

1. Panel ID Utility
2. Thermal & Fan Utility
3. Mother Board Data Utility

To use this diskette, first boot from this diskette, then a "Microsoft Windows ME Startup Menu" prompt you to choose the testing item. Follow the instructions on screen to proceed.

**NOTE:** This program contains a readme.txt file. This readme.txt file will introduce each test utility and its functions.

## System Diagnostic Diskette

**IMPORTANT:** <sup>1</sup>The diagnostics program we use for TravelMate 270 series is not exactly the same as PQA (Product Quality Assurance), the diagnostic program we used to employ in other model. The system diagnostic utilities is provided by Acer Headquarters. You can utilize it as a basic diagnostic tool. To get this program, find it in the TravelMate 270 series service CD kit. To better fit local service requirements, your regional office MAY have other diagnostic program. Please contact your regional offices or the responsible personnel/channel to provide you with further technical details.

**NOTE:** For ASSY Function Test Procedure, please prepare the following items for system components test: SIO/PIO loopback, diskette, mouse (PS/2), CD-Disk (Test Program), battery pack, SYS\_card (Card Bus)X2, AC-adapter, keyboard, external speaker and feather.

---

<sup>1</sup> New added description. Please pay attention to it.

## Running Diagnostics Program

### 1. BIOS Re-flash

Insert CD-Disk and floppy disk then boot from floppy disk drive to BIOS re-flash.

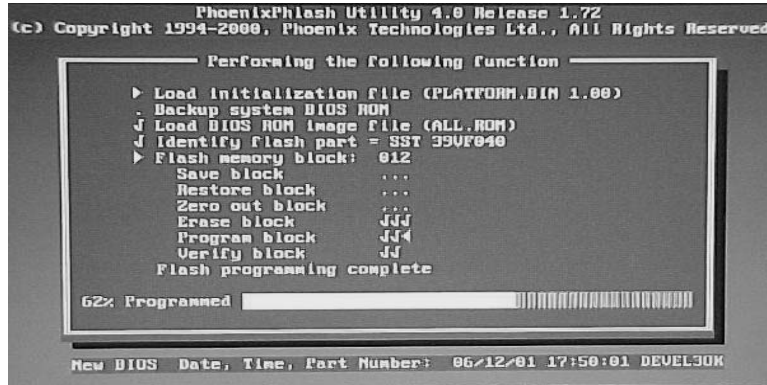

### 2. Serial Port, Parallel Port and FDD Test

Insert SIO/PIO loopback to serial/parallel port. Place the diskette in the floppy diskette drive. Then run the test utility.

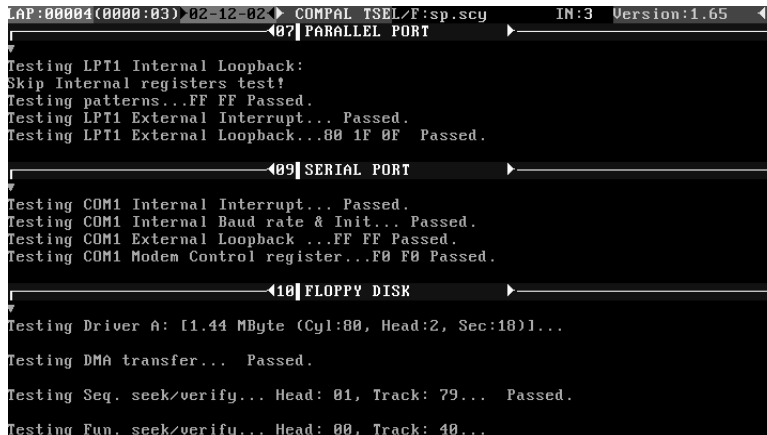

### 3. CMOS RTC and FDD Test

Insert the diskette to the floppy disk drive for test.

```

Wait for zero counter...
Testing...>17:06:174
DOS TIME = 17:06:17.13(6157713), CMOS TIME = 17:06:17(6157700)
DOS DATE: 02/14/2002, CMOS DATE: 02/14/2002
DATE & TIME test Passed.

<05| COMPACT DISC ROM |>

CD ROM Drive E:, MSCDEX ver.: 2.25, Driver name: CDROM1 , Vol.: COMPAL_TEST
Total 264496 sectors(2352 bytes/sector) = 622094592 bytes

Testing for DATA CD:
Testing CD ROM reset function...Passed.
Testing seq. read... sector: 243295( 24)
Testing fun. read... sector: 116359( 23) Passed.

<06| CDROM CHECK2 |>

CD ROM Drive E:, MSCDEX ver.: 2.25, Driver name: CDROM1 , Vol.: COMPAL_TEST
Total 264496 sectors(2352 bytes/sector) = 622094592 bytes

Testing Eject/Close door:
Eject door Passed.

```

#### 4. Thermal Test

```

Begin Time(mm/dd hh:mm:ss) 03/17 21:41:31
Remote_Temp.=59 [70]Local_Temp.=61 [65] 03/17 21:41:31
Remote_Temp.=59 [70]Local_Temp.=61 [65] 03/17 21:41:32
Remote_Temp.=59 [70]Local_Temp.=61 [65] 03/17 21:41:33
PASS + PASS +
C:\DOSTEST\THERMAL>pause
Press any key to continue . . .

C:\DOSTEST\THERMAL>cd\
C:\>
C:\>

```

#### 5. Config Test

```

System Manufacturer      COMPAL
System Product           CY25
Mother Board Manufacturer COMPAL
Mother Board Model       CY25
BIOS Manufacturer       Phoenix Technologies LTD
BIOS Version             B125_0.17
Processor Speed          1200 MHz
Processor Packet         uPGA479M Socket
Processor Manufacturer   Intel Corporation
Cache size               512 KB
Memory Size              256 MB
LCD Panel                ID 1 : CLAA 141XP01 14.1" XGA 1024x768
                        1024x768
Primary Battery          Panasonic Li-ion
Secondary Battery        None
Primary IDE              ATA device
                        IC25N020ATCS04-0
                        20000 MB
Secondary IDE            ATAPI device
                        HL-DT-STDUD-ROM GDR0001N

Press any key to continue . . .

```

#### 6. 1394 ID Check

If you need to confirm whether the 1394GUID serial number has been input or not, you can run this utility. Press **[ESC]** then Y key to next test.





**7. Touchpad Test**

After you run the utility, please point and move your finger on the touchpad. Then see if the movement of the cursor can reach to left top (X=0, Y=0). Press the right and left button then continue next test.



**8. VGA R.G.B. Mode Test**

Inspects red, green and blue color of display quality. Press any key to continue next test.

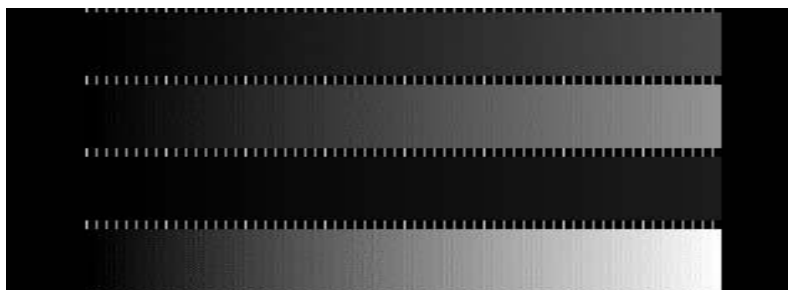

## 9. FAN Test

Check if the fan has turned on or not. You can confirm the function by a feather.



## 10. Keyboard Test

Press all keys according to this order--from left to right and from up to down to test each key's function. If pass then press **CTRL** + Break to continue the next test.



## 11. 32bit Systemcard Test

Insert two pieces of Syscard (Card bus) into PCMCIA slots for test.

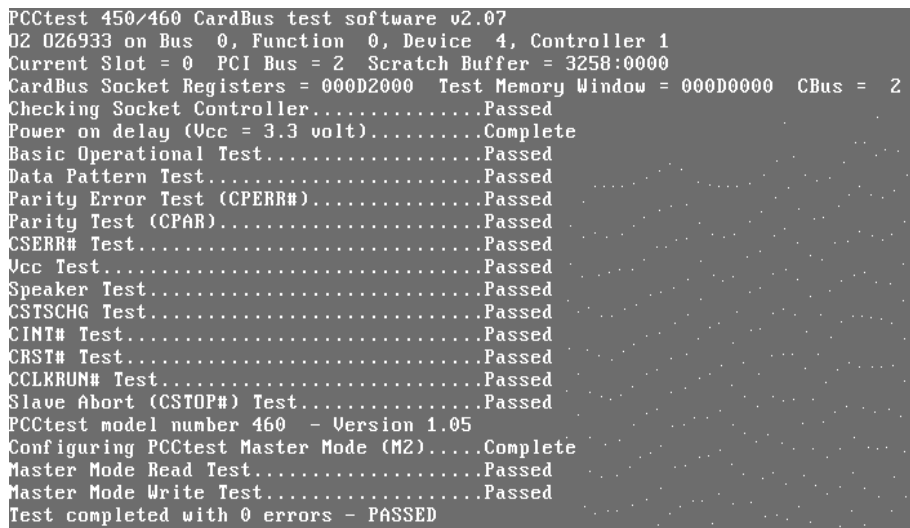

## 12. Audio Test

Test the left channel first. After you hear a sound press **ENTER** to test the right channel.

```
ALC101/200/201/201A/202A/650/202/ALC100 (Audio OK ?) Autest Program

1. Play a wave file (48k sampling rate/16-bits stereo file)
   You must hear some music. Yes/No ?
   Press 'S' or any Key to stop playing a wave file
   Press 'P' Key to pause playing and any key to go on
   Press 'F' key (If the function is failed)
   Playing properly finish !
2. Test Primary Codec Reset(Cold/Warm/Register) :
   Codec Reset Test Success!
3. Test Codec Register Default(Primary) :
   Codec Register Default Test Success!
4. Test Codec Register R/W(Primary) :
   Codec Register R/W Test Success!
5. Test Codec Complete Power Down(Primary) :

[F10] to EXIT

Copyright(C) 2002, Realtek Semiconductor CO. Ltd
```

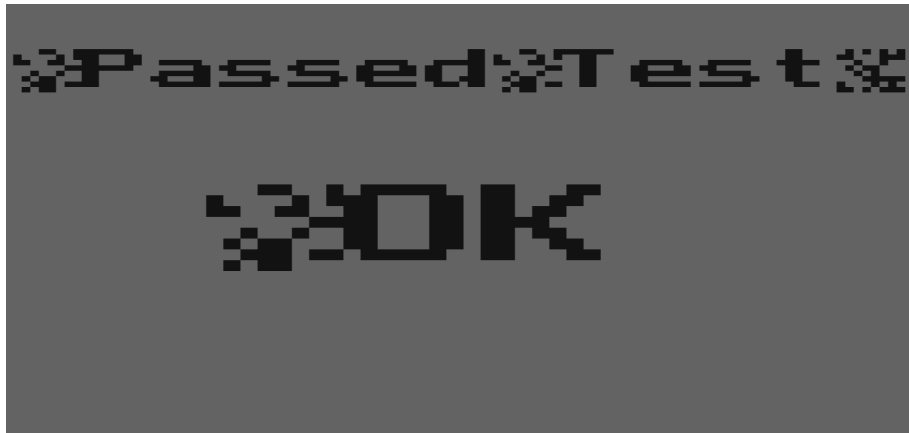

## 13. Battery Charge Test

Plug in AC adapter to the system for test.

```
ONLY FOR 87591 Series Battery Test Program.[591] V1.3 2001/11/15
MAIN Battery
Manufacturer: Panasonic                      Serial Number : 5585
Design Capacity Value           = 3900mAh
Battery fullcharge Capacity     = 3900mAh
Design Voltage Value            = 14800mV [Lion]
Available Percentage Value      = 1164mAh [29.8%] (Relative) [10.0%]
Charge -> Remaincharge capacity = 1164 1166 [ PASS ]
C:\DOSTEST>
```

## Machine Disassembly and Replacement

---

This chapter contains step-by-step procedures on how to disassemble the notebook computer for maintenance and troubleshooting.

To disassemble the computer, you need the following tools:

- Wrist grounding strap and conductive mat for preventing electrostatic discharge
- Small Philips screw driver
- Philips screw driver
- Flat head screwdriver
- Large flat head screw driver
- Tweezers
- Nut driver

**NOTE:** The screws for the different components vary in size. During the disassembly process, group the screws with the corresponding components to avoid mismatch when putting back the components. When you remove the stripe cover, please be careful not to scrape the cover.

---

## General Information

### Before You Begin

Before proceeding with the disassembly procedure, make sure that you do the following:

1. Turn off the power to the system and all peripherals.
2. Unplug the AC adapter and all power and signal cables from the system.
3. Remove the battery pack.

**NOTE:** TravelMate 270 series product uses mylar or tape to fasten the FFC/FPC/connectors/cable, you may need to tear the tape or mylar before you disconnect different FFC/FPC/connectors.

# Disassembly Procedure Flowchart

The flowchart on the succeeding page gives you a graphic representation on the entire disassembly sequence and instructs you on the components that need to be removed during servicing. For example, if you want to remove the system board, you must first remove the keyboard, then disassemble the inside assembly frame in that order.

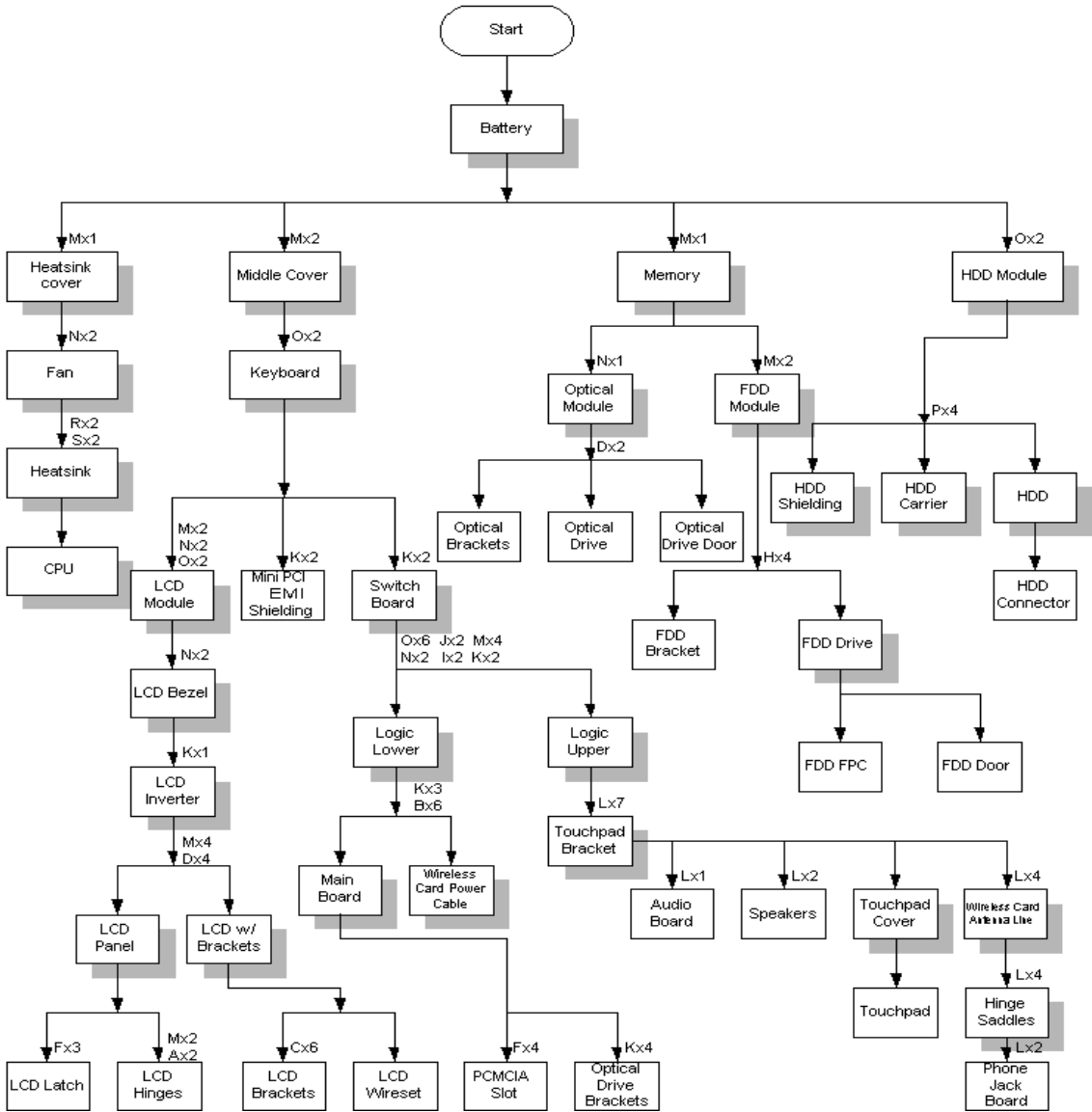

## Screw List

Item	Description
A	CPU FRAME NUT
B	Screw, #4-40UNF
C	Screw, M2.0X2.5NL
D	Screw, M2.0X3
E	Screw, M2.0X3NL
F	Screw, M2.0X5
G	Screw, M2.0X7

---

<b>Item</b>	<b>Description</b>
H	Screw, M2.0X0.4P+3FP-ZK(NL)
I	Screw, M2.5X12
J	Screw, M2.5X18
K	Screw, M2.5X3NL
L	Screw, M2.5X4
M	Screw, M2.5X5
N	Screw, M2.5X7NL
O	Screw, M2.5X9NL
P	Screw, M3.0X3
Q	Screw, TPB-1.7 3.5P-ZK(NL)
R	Thermal screw with spring
S	Thermal screw with white spring

---

## Removing the Battery Pack

1. Press the battery lock and slide the battery latch to the right.
2. Then remove the battery.





---

# Removing the HDD Module/Memory/FDD Module/Optical Module and CPU

## Removing the HDD Module

1. Remove the two screws that secure the HDD module.
2. Then take the HDD module away.

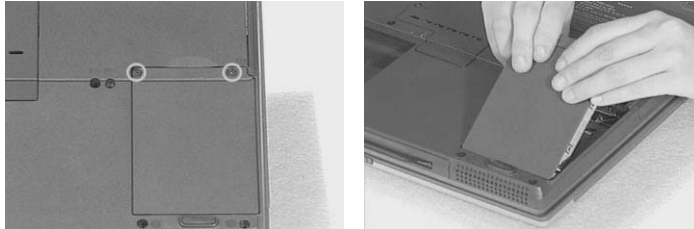

## Removing the Memory

1. Remove the screw as shown here.
2. Remove the DIMM door.
3. Then prize out the memory with the fingers.



## Removing the FDD Module

1. Remove the screw that secures the FDD module.
2. Disconnect FDD FPC.
3. Then remove the FDD module.

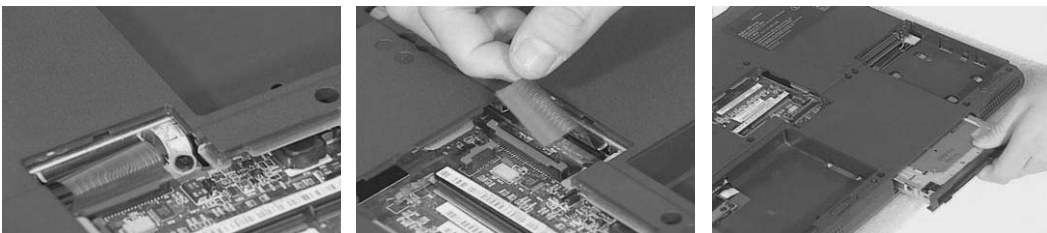

## Removing the Optical Module

1. Remove the screw that secures the optical module.
2. Push the optical module outwards.
3. Then take out the optical module.

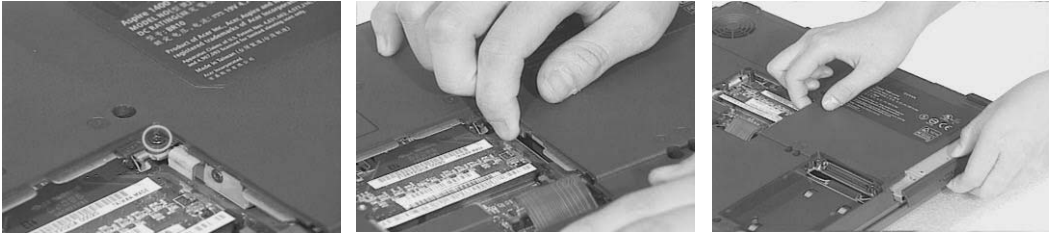

## Removing the CPU

1. Replace the screw that secure the heatsink cover.
2. Remove the heatsink cover.

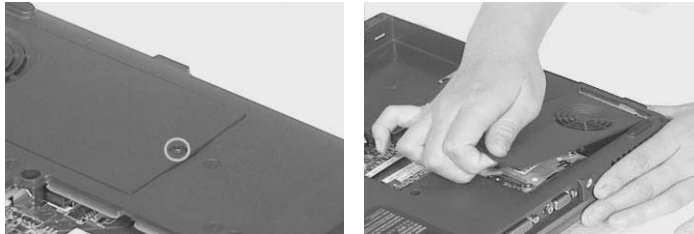

3. Disconnect the fan power cable.
4. Remove the two screws that secure the fan.
5. Then remove the fan.

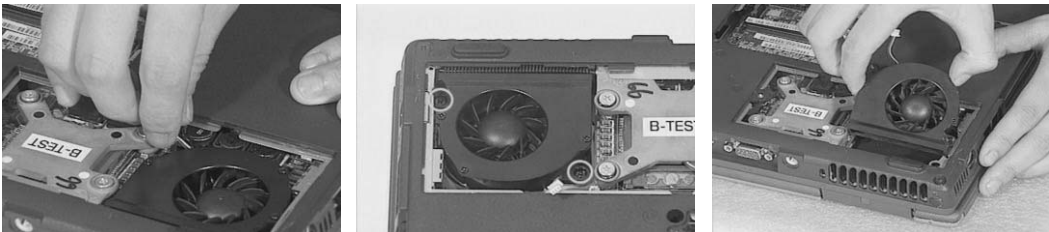

6. Remove the four screws as shown.
7. Then remove the heatsink.

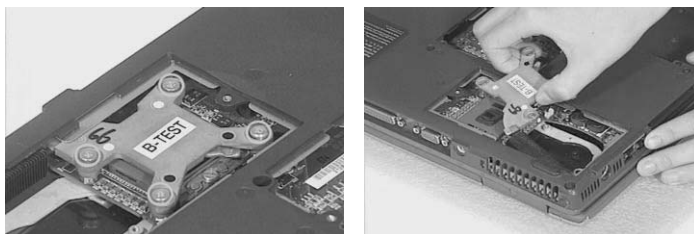

8. Unlock the CPU lock with the flat head screwdriver.
9. Then remove the CPU

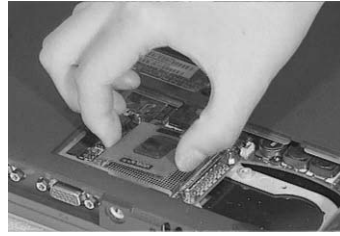
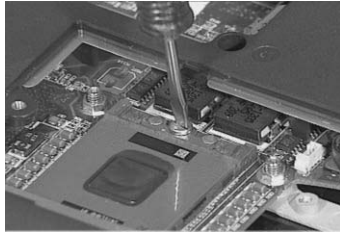

# Removing the LCD Module and Switch Board

## Removing the LCD Module

1. Remove the two (one on each side) screws holding the middle cover.
2. Use a tool to pull the keyboard locks outwards as shown here.
3. Prize the middle cover with a plastic flat head screwdriver.



4. Unscrew the two screws as shown here.
5. Place the keyboard as the picture shows.
6. Disconnect the keyboard cable..



7. Disconnect the LCD power cable.
8. Unscrew the two screws as shown here. One on each side.
9. Then, remove the two screws as shown here. One on each side.

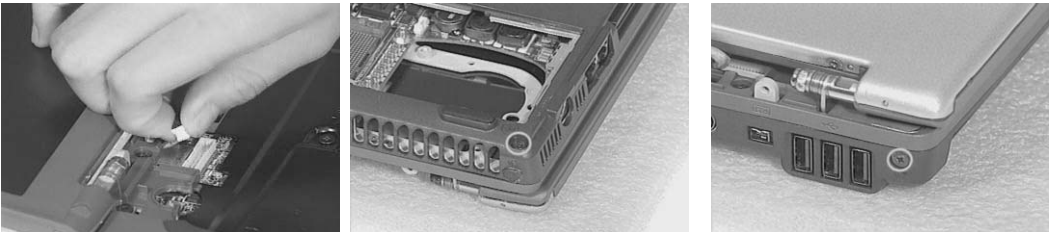

10. Remove the two screws holding the LCD hinges.
11. Then, remove the LCD module from the main unit.

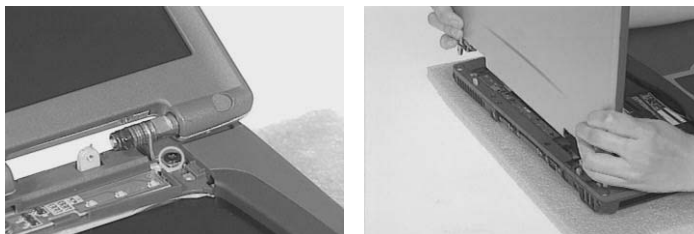

---

## Removing the Switch Board

1. Unscrew the two screws that secure the switch board.
2. Then remove the switch board from the main unit.

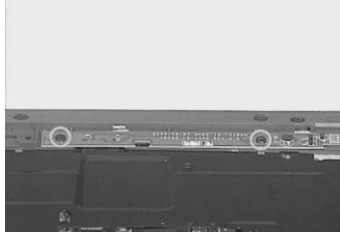

## Disassembling the Main Unit

### Separate the main unit into the logic upper and the logic lower assembly

1. Unscrew the two screws holding the Mini PCI EMI shielding then remove it from the main unit.
2. Disconnect the audio board FFC..

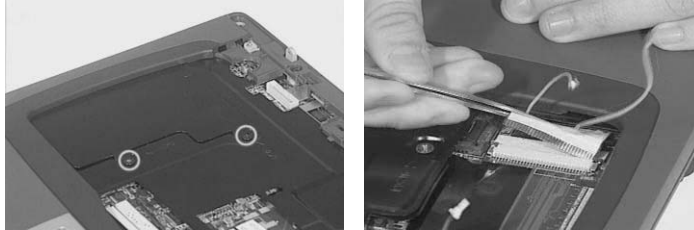

3. Remove the 11 screws on the lower case.
4. Remove the 5 screws holding the upper case.
5. Disattach the logic upper form the logic lower..

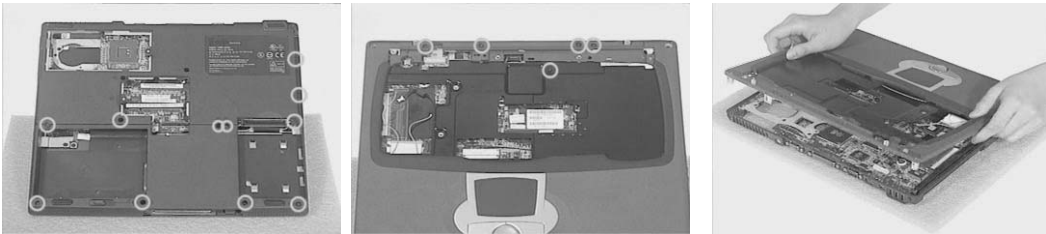

### Disassembling the logic upper

1. Unscrew the 7 screws holding the touchpad bracket. Then remove the touchpad bracket.
2. Disconnect the two speakers' cable.

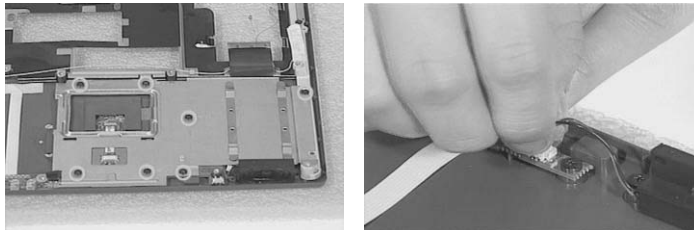

3. Disconnect the touchpad FFC from the audio board.
4. Unscrew one screw as shown here. Then turn over the audio board.

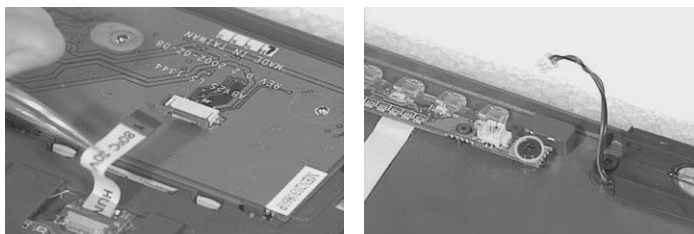

5. Disconnect the phone jack FFC from the audio board. Then remove the audio board.
6. Disconnect the audio board FFC from the audio board.
7. Disattach the touchpad cover latch.

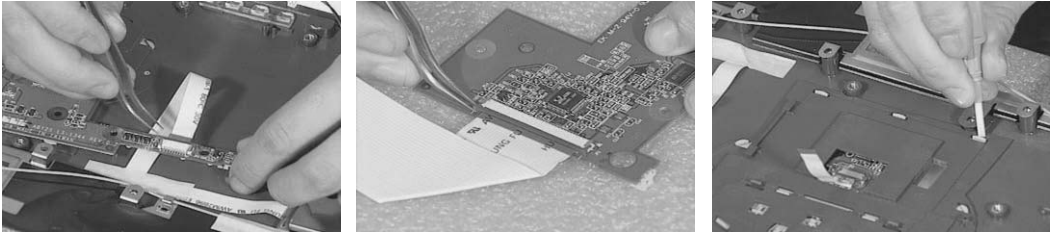

8. Turn over the upper case and disattach the touchpad cover from the upper case.
9. Remove the touchpad.
10. Disconnect the touchpad FFC.



11. Unscrew the screws holding the speakers; one on each side.
12. Remove the two screws that hold the wireless card antenna line; two on each side.
13. Unscrew the two screws that secure the hinge saddles, then remove the right and left hinge saddles.

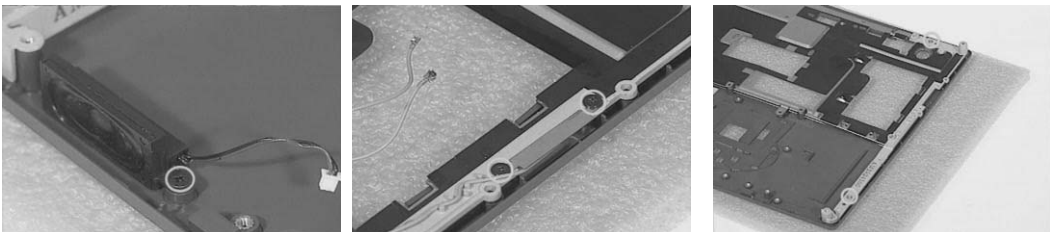

14. Remove the two screws holding the phone jack board. Then remove the phone jack board shielding.
15. Disconnect the phone jack FFC.
16. Remove the EMI shielding from the upper case.

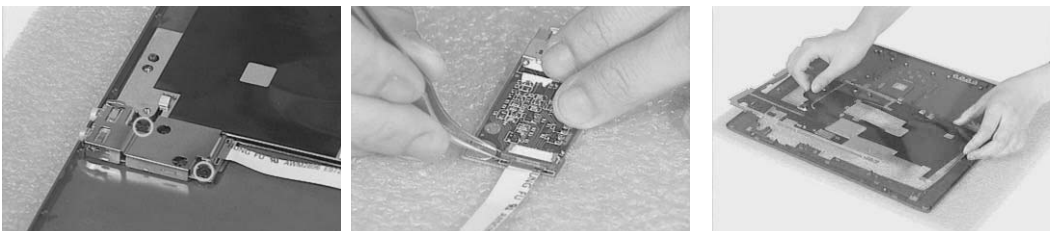

---

## Disassembling the logic lower

1. Tear off the mylar that fastens the wireless card power cable.
2. Disconnect the wireless card power cable and remove it from the main board.

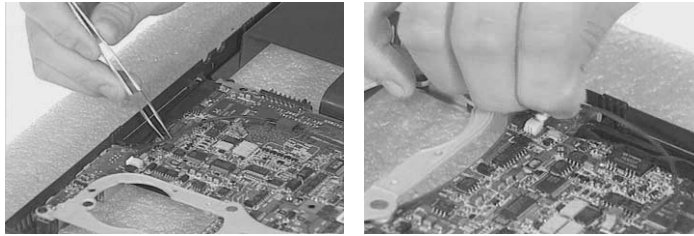

3. Unscrew the three screws that secure the main board to the lower case.
4. Remove the six nuts with a nut screwdriver. Two screws that secure the main board.
5. Then take out the main board from the lower case.

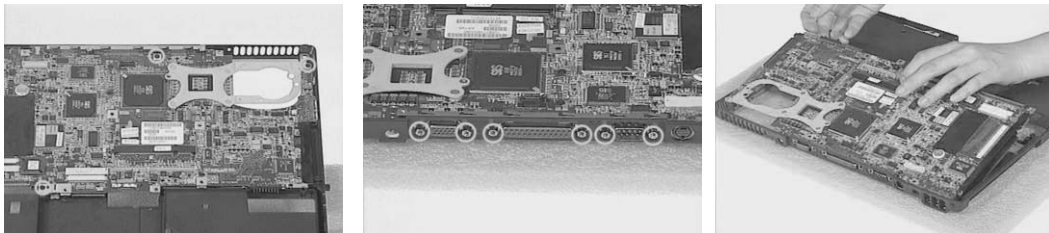

6. Remove the four screws holding the optical drive bracket then remove it from the main board.
7. Remove the four screws that secure the PCMCIA slot and remove it from the main board.

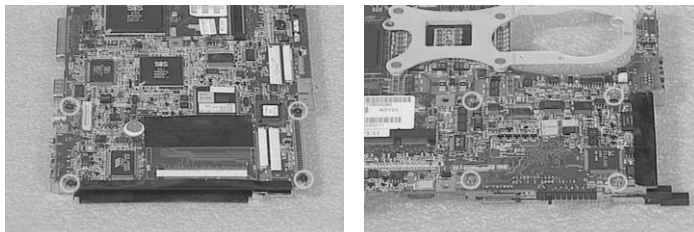



## Disassembling the LCD Module

1. Remove the two screwpad then unscrew the two screws on the LCD bezel. One on each side.
2. Disattach the LCD bezel from the upper side of the LCD module carefully..

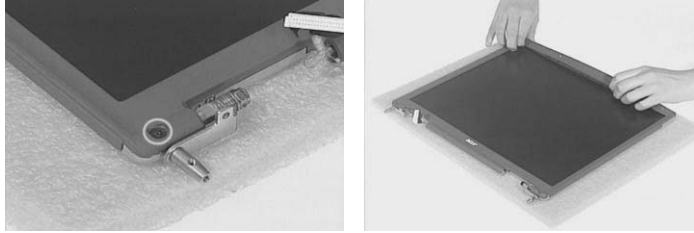

3. Unscrew the screw that holds the LCD inverter.
4. Disconnect the LCD wire set and LCD power cable from the LCD inverter.
5. Remove the eight screws that secure the LCD to LCD panel; four on each side.



6. Remove the LCD from the LCD panel.
7. Remove the six screws holding the right and the left LCD brackets. Four on each side.
8. Tear off the mylar that fastens the LCD wire set..

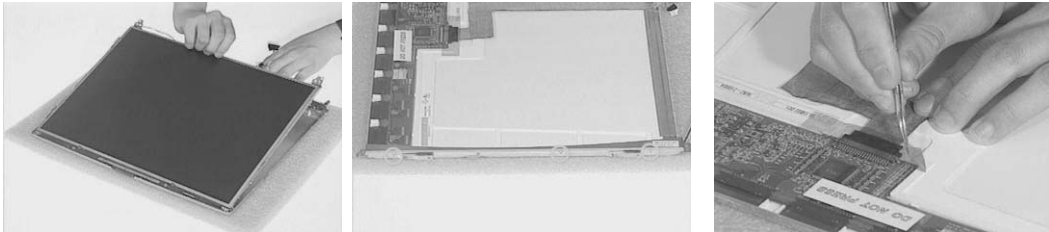

9. Disconnect the LCD wire set.
10. Unscrew the two screws that secure the right and left hinges. Then remove the two hinges.
11. Unscrew the three screws then remove the LCD latch.



---

## Disassembling the External Modules

### Disassembling the HDD Module

1. Remove the four (two on each side) screws on HDD carrier.
2. Remove the HDD EMI shielding and take out the HDD from the carrier.
3. Disconnect the hard disk drive connector.



### Disassembling the Floppy Disk Drive Module

1. Remove the four screws (two on each side) that secure the FDD to the FDD bracket. Then remove the FDD from the FDD bracket.
2. Disconnect FDD FFC.
3. Use a tool (a tip of a pen or an uncurved paper clipper) to release the FDD door lock on one side, then the other. And you can remove the FDD door.

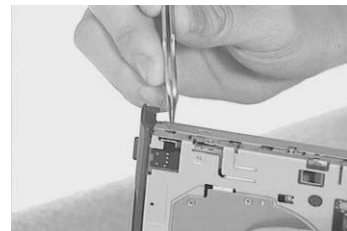
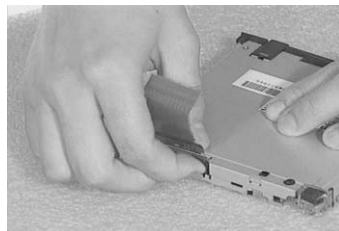
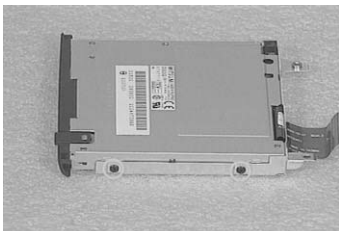

### Disassembling the Optical Drive Module

1. Unscrew the two screws holding the optical bracket.
2. Then remove the optical bracket.





# Troubleshooting

Use the following procedure as a guide for computer problems.

**NOTE:** The diagnostic tests are intended to test this model (TravelMate 270 series). Non-Acer products, prototype cards, or modified options can give false errors and invalid system responses.

1. Obtain the failed symptoms in as much detail as possible.
2. Verify the symptoms by attempting to re-create the failure by running the diagnostic test or by repeating the same operation.
3. If any problem occurs, you can perform visual inspection before you follow this chapter's instructions. You can check the following:
  - power cords are properly connected and secured;
  - there are no obvious shorts or opens;
  - there are no obviously burned or heated components;
  - all components appear normal.
4. After you perform visual inspection you can also verify the following:
  - ask the user if a password is registered and, if it is, ask him or her to enter the password.
  - verify with the customer that Windows XP is installed on the hard disk. Operating systems that were not preinstalled by Acer can cause malfunction.
  - make sure all optional equipment is removed from the computer.
  - make sure the floppy disk is empty.
5. Use the following table with the verified symptom to determine which page to go to.

Symptoms (Verified)	Go To
Power failure. (The power indicator does not go on or stay on.)	"Power System Check" on page 73.
POST does not complete. No beep or error codes are indicated.	"Power-On Self-Test (POST) Error Message" on page 77 "Undetermined Problems" on page 84
POST detects an error and displayed messages on screen.	"Error Message List" on page 78
The diagnostic test detected an error and displayed a FRU code.	"System Diagnostic Diskette" on page 49
Other symptoms (i.e. LCD display problems or others).	"Power-On Self-Test (POST) Error Message" on page 77
Symptoms cannot be re-created (intermittent problems).	Use the customer-reported symptoms and go to "Power-On Self-Test (POST) Error Message" on page 77 "Intermittent Problems" on page 83 "Undetermined Problems" on page 84

---

# System Check Procedures

## External Diskette Drive Check

Do the following steps to isolate the problem to a controller, driver, or diskette. A write-enabled, diagnostic diskette is required.

**NOTE:** Make sure that the diskette does not have more than one label attached to it. Multiple labels can cause damage to the drive or cause the drive to fail.

Do the following to select the test device. See “System Diagnostic Diskette” on page 49 for details.

1. The FDD heads can become dirty over time, affecting their performance. Use an FDD cleaning kit to clean the heads. If the FDD still does not function properly after cleaning, go to next step.
2. Boot from diagnostic program (see “System Diagnostic Diskette” on page 49)
3. If an error occurs with the internal diskette drive, reconnect the diskette connector on the main board.

If the error still remains:

1. Reconnect the external diskette drive module.
2. Replace the external diskette drive module.
3. Replace the main board.

## External CD-ROM/DVD-ROM Drive Check

Do the following to isolate the problem to a controller, drive, or CD-ROM/DVD-ROM. Make sure that the CD-ROM does not have any label attached to it. The label can cause damage to the drive or can cause the drive to fail.

Do the following to select the test device:

1. Insert an audio CD into the CD/DVD drive. If the CD/DVD drive can read the data from the audio CD. The drive does not have problem, then go to next step. If the CD/DVD LED on the front panel does not emit light as it read the data from the audio CD, then go to next step. However, if the CD/DVD drive can not read data from the audio CD, you may need to clean the CD/DVD drive with a CD/DVD drive cleaning disk.
2. Make sure that the appropriate driver has been installed on the computer for the CD/DVD drive.
3. Boot from the diagnostics diskette and start the diagnostics program (refer to “System Diagnostic Diskette” on page 49.)
4. See if CD-ROM Test is passed when the program runs to CD-ROM/DVD-ROM Test.
5. Follow the instructions in the message window.

If an error occurs, reconnect the connector on the main board. If the error still remains:

1. Reconnect the CD-ROM/DVD-ROM module.
2. Replace the CD-ROM/DVD-ROM module.
3. Replace the main board.

---

## Keyboard or Auxiliary Input Device Check

Remove the external keyboard if the internal keyboard is to be tested.

If the internal keyboard does not work or an unexpected character appears, make sure that the flexible cable extending from the keyboard is correctly seated in the connector on the main board.

If the keyboard cable connection is correct, run the Keyboard Test. See “System Diagnostic Diskette” on page 49 for more details.

If the tests detect a keyboard problem, do the following one at a time to correct the problem. Do not replace a non-defective FRU:

1. Reconnect the keyboard cables.
2. Replace the keyboard.
3. Replace the main board.

The following auxiliary input devices are supported by this computer:

- Embedded Numeric Keypad
- External keyboard

If any of these devices do not work, reconnect the cable connector and repeat the failing operation.

## Memory Check

Memory errors might stop system operations, show error messages on the screen, or hang the system. Currently, we do not provide memory test program. However, if you need to check memory but have no testing program or diagnostic utility at hand, please go to <http://www.passmark.com> to download the shareware “BurnIn Test V.3.0”. You may test the memory with this program under Window XP environment.

**NOTE:** Make sure that the DIMM is fully installed into the connector. A loose connection can cause an error.

## Power System Check

To verify the symptom of the problem, power on the computer using each of the following power sources:

1. Remove the battery pack.
2. Connect the power adapter and check that power is supplied.
3. Disconnect the power adapter and install the charged battery pack; then check that power is supplied by the battery pack.

If you suspect a power problem, see the appropriate power supply check in the following list:

- “Check the Power Adapter” on page 74
- “Check the Battery Pack” on page 75

---

## Check the Power Adapter

Unplug the power adapter cable from the computer and measure the output voltage at the plug of the power adapter cable. See the following figure

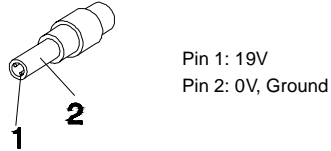

1. If the voltage is not correct, replace the power adapter.
2. If the voltage is within the range, do the following:
  - Replace the main board.
  - If the problem is not corrected, see “Undetermined Problems” on page 84.
  - If the voltage is not correct, go to the next step.

**NOTE:** An audible noise from the power adapter does not always indicate a defect.

3. If the DC-IN indicator does not light up, check the power cord of the power adapter for correct continuity and installation.
4. If the operational charge does not work, see “Check the Power Adapter” on page 74.

---

## Check the Battery Pack

To check the battery pack, do the following:

From Software:

1. Check out the Power Options in control Panel
2. In Power Meter, confirm that if the parameters shown in the screen for Current Power Source and Total Battery Power Remaining are correct.
3. Repeat the steps 1 and 2, for both battery and adapter.
4. This helps you identify first the problem is on recharging or discharging.

From Hardware:

1. Power off the computer.
2. Remove the battery pack and measure the voltage between battery terminals 1(+) and 6(ground).
3. If the voltage is still less than 7.5 Vdc after recharging, replace the battery.
4. If the voltage is within the normal range, run the diagnostic program.

To check the battery charge operation, use a discharged battery pack or a battery pack that has less than 50% of the total power remaining when installed in the computer.

If the battery status indicator does not light up, remove the battery pack and let it return to room temperature. Re-install the battery pack.

If the charge indicator still does not emit, replace the battery pack. If the charge indicator still does not light up, replace the DC/DC charger board.

## Touchpad Check

If the touchpad doesn't work, do the following actions one at a time to correct the problem. Do not replace a non-defective FRU:

1. After rebooting, run Touch pad/PS2 Mode Driver.
2. Run utility with the PS/2 mouse function and check if the mouse is working.
3. If the PS/2 mouse does not work, then check if the main board to switch board FPC is connected well.
4. If the main board to switch board FPC is connected well, then check if the touch pad FPC connects to the main board properly.
5. If there is still an error after you have connected the touch pad FPC to the main board properly, then replace the touch pad or touch pad FPC. The touch pad or touch pad FPC may be damaged.
6. Replace switch board.
7. If the touch pad still does not work, then replace the FPC on Track Pad PCB.

After you use the touchpad, the pointer drifts on the screen for a short time. This self-acting pointer movement can occur when a slight, steady pressure is applied to the touchpad pointer. This symptom is not a hardware problem. No service actions are necessary if the pointer movement stops in a short period of time.

## Display Check

1. Connect an external display to the computer's external monitor port, the boot the computer. The computer can automatically detect the external display. Press Fn+  to switch to the external display.
2. If the external display works fine, the internal LCD may be damaged. Then perform the following steps:

Make sure the DDRRAM module is seated properly. Then run the display test again. If the problem still exists, go to next step.

Replace the inverter board, then run the display test program again. If the problem still occurs, go on next step.

Replace the LCD module with a new one then run the display test again. If the problem still happens, continue next step.

Replace LCD/FL cable with a new one then execute the display diagnostic again. If the problem



---

still occurs, continue next step.

Replace the CPU with another of the same specifications. If the problems still occurs, go to next step.

The main board may be damaged. Replace main board.

3. If the external monitor has the same problem as the internal monitor, the main board may be damaged. Please insert the diagnostic disk and run the display test program and go through the sub-steps under step 2.

## Sound Check

To determine if the computer's built-in speakers are functioning properly, perform the following steps. Before you start the steps below, adjust the speaker volume to an appropriate level.

1. Try different audio sources. For example, employ audio CD and digital music file to determine whether the fault is in the speaker system or not. If not all sources have sound problem, the problem is in the source devices. If all have the same problem, continue next step.
2. Connect a set of earphone or external speakers. If these devices work fine, go to next step. If not, then the main board may be defective or damaged. Replace the main board.
3. Follow the disassembling steps in Chapter 3. Ensure the speaker cable is firmly connected to the main board. If the speaker is still a malfunction, go on next step.
4. If the speakers do not sound properly, the speakers may be defective or damaged. Replace the speakers. If the problem still occurs, then replace the main board.

---

## Power-On Self-Test (POST) Error Message

The POST error message index lists the error message and their possible causes. The most likely cause is listed first.

**NOTE:** Perform the FRU replacement or actions in the sequence shown in FRU/Action column, if the FRU replacement does not solve the problem, put the original part back in the computer. Do not replace a non-defective FRU.

This index can also help you determine the next possible FRU to be replaced when servicing a computer.

If the symptom is not listed, see “Undetermined Problems” on page 84.

The following lists the error messages that the BIOS displays on the screen and the error symptoms classified by function.

**NOTE:** Most of the error messages occur during POST. Some of them display information about a hardware device, e.g., the amount of memory installed. Others may indicate a problem with a device, such as the way it has been configured.

**NOTE:** If the system fails after you make changes in the BIOS Setup Utility menus, reset the computer, enter Setup and install Setup defaults or correct the error.

# Index of Error Messages

## Error Message List

Error Messages	FRU/Action in Sequence
0200 Failure Fixed Disk	Hard disk error detected. Check to see if fixed disk is attached properly. Enter the BIOS Setup Utility and verify the hard disk is detected.
0211 Keyboard error	see "Keyboard or Auxiliary Input Device Check" on page 73.
0212 Keyboard Controller Failed	see "Keyboard or Auxiliary Input Device Check" on page 73. May require replacing the keyboard controller.
0213 Keyboard locked - Unlock key switch	Unlock the system to proceed.
0220 Monitor type does not match CMOS - Run SETUP	Display device mismatch. Enter the BIOS Setup Utility and verify the parameters (try loading the default settings); then save and restart the computer.
0230 System RAM Failed at offset: nnnn	Shadow RAM test failed Main board
0231 Shadow RAM Failed at offset: nnnn	System RAM test failed Main board
0232 Extended RAM Failed at address line: nnnn	Extended RAM test failed Main board
0250 System battery is dead - Replace and run SETUP	CMOS clock battery needs to be replaced. Replace the battery and run BIOS Setup Utility to reconfigure system time, then reboot system.
0251 System CMOS checksum bad - Default configuration used	CMOS has been corrupted or modified incorrectly. Run BIOS Setup Utility and verify the parameters; then save and restart the computer. Check the system battery.
0260 System timer error	System timer test failed, and the main board needs to be repaired. Run BIOS Setup Utility to reconfigure system time, then reboot system. Main board
0270 Real time clock error	RTC battery Run BIOS Setup Utility to reconfigure system time, then reboot system. Main board
0280 Previous boot incomplete - Default configuration used	Previous boot-up was not completed successfully. Enter the BIOS Setup Utility and verify the parameters (try loading the default settings); then save and restart the computer. RTC battery Main board
0281 Memory size found by POST differed from EISA CMOS	Run "Load Setup Defaults" in BIOS Setup Utility. Main board
02B0 Diskette drive A error	Drive A: or B: is present but fails the BIOS POST diskette tests. Check the drive is defined with the proper diskette type in BIOS Setup Utility Check if the diskette drive is attached correctly. See "External Diskette Drive Check" on page 72.
02B2 Incorrect Drive A type - run SETUP	Type of floppy drive A: not correctly identified in Setup. Main board
02D0 System cache error - Cache disabled	RAM cache failed and BIOS disabled the cache. On older boards, check the cache jumpers. You may have to replace the cache. Main board

## Error Message List

Error Messages	FRU/Action in Sequence
02F0 CPU ID	CPU socket number for Multi-Processor error. Main board
02F4 EISA CMOS not writeable	System unable to write to EISA CMOS. Main board
02F5 DMA Test Failed	System unable to write to DMA (Direct Memory Access) registers. Main board
02F6 Software NMI Failed	System unable to generate software NMI (Non-Maskable Interrupt). Main board
02F7 Fail-Safe Timer NMI Failed	Fail-Safe Timer takes too long. Main board
Invalid System Configuration Data	Error with NVRAM (CMOS) data. Enter the BIOS Setup Utility and verify the parameters (try loading the default settings); then save and restart your computer. Main board
Operating system not found	Operating system cannot be found on the boot device. Enter the BIOS Setup Utility and verify the parameters (try loading the default settings); then save and restart the computer. Recover hard disk. Reinstall the operating system.
Parity Check 1 <i>nnnn</i>	Parity error found on system bus. BIOS attempts to locate the address and display it on the screen. If it cannot locate the address, it displays.
Parity Check 2 <i>nnnn</i>	Parity error found on I/O bus. BIOS attempts to locate the address and display it on the screen. If it cannot locate the address, it displays .

# Index of Symptom-to-FRU Error Message

## LCD-Related Symptoms

Symptom / Error	Action in Sequence
LCD backlight doesn't work LCD is too dark LCD brightness cannot be adjusted LCD contrast cannot be adjusted	Enter BIOS Utility to execute "Load Setup Defaults" on Exit screen, then reboot system. Reconnect the LCD connectors. Keyboard (if contrast and brightness function key doesn't work). LCD cable LCD inverter LCD Main board
Unreadable LCD screen Missing pels in characters Abnormal screen Wrong color displayed	Reconnect the LCD connector LCD cable LCD inverter LCD Main board
LCD has extra horizontal or vertical lines displayed.	LCD inverter LCD cable LCD Main board

## Indicator-Related Symptoms

Symptom / Error	Action in Sequence
Indicator incorrectly remains off or on, but system runs correctly	Reconnect the inverter board Inverter board Main board

## Power-Related Symptoms

Symptom / Error	Action in Sequence
Power shuts down during operation	Power source (battery pack and power adapter). See "Power System Check" on page 73. Battery pack Power adapter Hard drive & battery connection board Main board
The system doesn't power-on.	Power source (battery pack and power adapter). See "Power System Check" on page 73". Battery pack Power adapter Hard drive & battery connection board Main board
The system doesn't power-off.	Power source (battery pack and power adapter). See "Power System Check" on page 73. Hold and press the power switch for more than 4 seconds. Main board
Battery can't be charged	See "Check the Power Adapter" on page 74. Battery pack Main board

### PCMCIA-Related Symptoms

Symptom / Error	Action in Sequence
System cannot detect the PC Card (PCMCIA)	See "System Diagnostic Diskette" on page 49. Please run Sycard 32 Bit test. PCMCIA slot assembly Main board
PCMCIA slot pin is damaged.	PCMCIA slot assembly

### Memory-Related Symptoms

Symptom / Error	Action in Sequence
Memory count (size) appears different from actual size.	DIMM Main board

### Speaker-Related Symptoms

Symptom / Error	Action in Sequence
In Windows, multimedia programs, no sound comes from the computer.	See "Sound Check" on page 76 Audio driver Speaker Main board
Internal speakers make noise or emit no sound.	See "Sound Check" on page 76 Speaker Main board

### Power Management-Related Symptoms

Symptom / Error	Action in Sequence
The system will not enter hibernation	Keyboard (if control is from the keyboard) Hard disk drive Main board
The system doesn't enter hibernation mode and four short beeps every minute.	Press Fn+F4 and see if the computer enters hibernation mode. Touchpad Keyboard Hard disk connection board Hard disk drive Main board
The system doesn't enter standby mode after closing the LCD	LCD cover switch Main board
The system doesn't resume from hibernation mode.	Hard disk connection board Hard disk drive Main board
The system doesn't resume from standby mode after opening the LCD.	LCD cover switch Main board
Battery fuel gauge in Windows doesn't go higher than 90%.	Remove battery pack and let it cool for 2 hours. Refresh battery (continue use battery until power off, then charge battery). Battery pack Main board
System hangs intermittently.	Reconnect hard disk drives. Hard disk drive connector Main board

### Peripheral-Related Symptoms

Symptom / Error	Action in Sequence
System configuration does not match the installed devices.	Enter BIOS Setup Utility to execute "Load Setup defaults", then reboot system. Reconnect hard disk/CD-ROM/diskette drives.
External display does not work correctly.	See "System Diagnostic Diskette" on page 49 See if there is an error beep. If there is an error beep, then change main board. Power off. Then check if RAM CPU BIOS are well-connected. Press Fn+F5 three times slowly LCD FPC LCD inverter LCD
USB does not work correctly	USB device cable is firmly connected into the USB ports. Test one USB port each time. USB socket is firmly secured to the main board. Main board
Print problems.	Ensure the "Parallel Port" in the "System Devices" of BIOS Setup Utility is set to Enabled. Onboard Devices Configuration Run parallel port test Printer driver Printer cable Printer Main board

### Keyboard/Touchpad-Related Symptoms

Symptom / Error	Action in Sequence
Keyboard (one or more keys) does not work.	Reconnect the keyboard cable. Keyboard Main board
Touchpad does not work.	Reconnect touch pad cable. Modem port is secured to the main board Touch pad FPC Audio/Touch pad board Main board

### Modem-Related Symptoms

Symptom / Error	Action in Sequence
Internal modem does not work correctly.	Ensure the telephone cable is firmly plugged into the telephone wall socket and the modem port of the computer. Modem phone port is secured to the main board. modem combo board Main board

**NOTE:** If you cannot find a symptom or an error in this list and the problem remains, see "Undetermined Problems" on page 84.

---

## Intermittent Problems

Intermittent system hang problems can be caused by a variety of reasons that have nothing to do with a hardware defect, such as: cosmic radiation, electrostatic discharge, or software errors. FRU replacement should be considered only when a recurring problem exists.

When analyzing an intermittent problem, do the following:

1. Run the diagnostic test for several times to isolate the problem.
2. If no error is detected, do not replace any FRU.
3. If any error is detected, replace the FRU. Rerun the test to verify that there are no more errors.

If an error is detected by the main battery test, see “Check the Power Adapter” on page 74

If an error is detected by the display test, see “Index of Symptom-to-FRU Error Message” on page 80 .

If an error is detected by the floppy disk drive test, see “External Diskette Drive Check” on page 72.

If an error is detected by the keyboard test, see “Keyboard or Auxiliary Input Device Check” on page 73.



---

## Undetermined Problems

The diagnostic problems does not identify which adapter or device failed, which installed devices are incorrect, whether a short circuit is suspected, or whether the system is inoperative.

Follow these procedures to isolate the failing FRU (do not isolate non-defective FRU).

**NOTE:** Verify that all attached devices are supported by the computer.

**NOTE:** Verify that the power supply being used at the time of the failure is operating correctly. (See "Power System Check" on page 71):

1. Power-off the computer.
2. Visually check them for damage. If any problems are found, replace the FRU.
3. Remove or disconnect all of the following devices:
  - Non-Acer devices
  - Printer, mouse, and other external devices
  - Battery pack
  - Hard disk drive
  - DIMM
  - CD-ROM/Diskette drive Module
  - PC Cards
4. Power-on the computer.
5. Determine if the problem has changed.
6. If the problem does not recur, reconnect the removed devices one at a time until you find the failing FRU.
7. If the problem remains, replace the following FRU one at a time. Do not replace a non-defective FRU:
  - Main board
  - LCD assembly

---

## Index of AFlash BIOS Error Message

Error Message	Action in Sequence
Hardware Error	See "System Diagnostic Diskette" on page 49
VPD Checksum Error	Reboot the system and then retest with this diskette.
BIOS Update Program Error	Turn off the power and restart the system.
System Error	Make sure this AFlash BIOS diskette for this model.
Without AC adapter	make sure to connect AC adapter
Battery Low	make sure to install a highly charged battery, and reboot system.



# Jumper and Connector Locations

## Top View

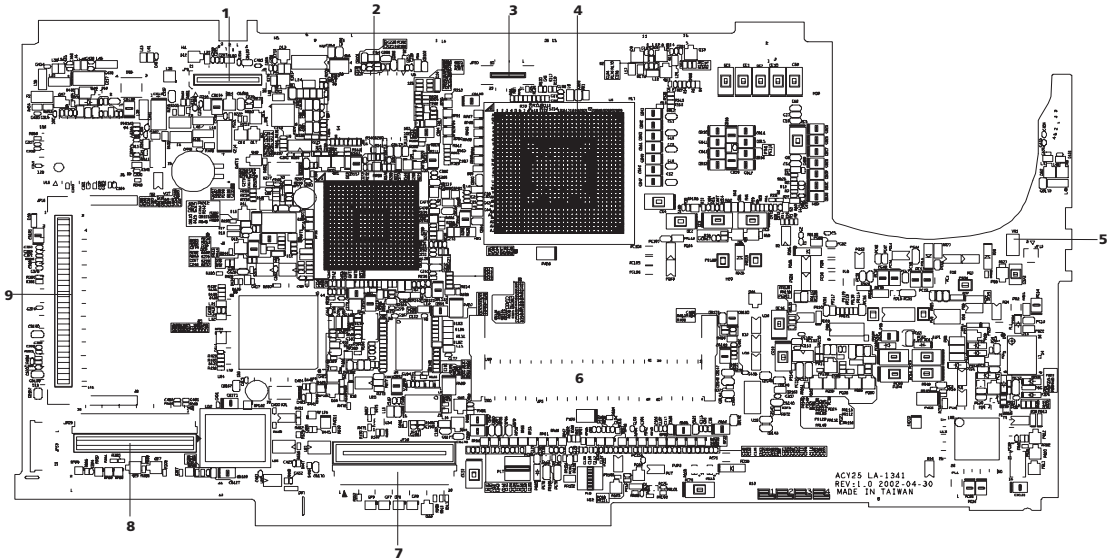

1-JP8	Panel connector	7-JP18	Int.keyboard interface connector
3-JP20	Switch button interface connector	8-JP29	Audio to main board connector
5-JP15	Modem connector	9-JP16	Mini-PCI connector
6-JP5	DDR-200P		

---

### SW1 Settings (Lid switch)

	Setting
Switch 1	NONE
Switch 2	STAND BY
Switch 3	HIBERNATE
Switch 4	ON/OFF BUTTON

### SW2 Settings

SW2	Setting
POWER BUTTON	ON:SYSTEM ON OFF: SYSTEM OFF

# Bottom View

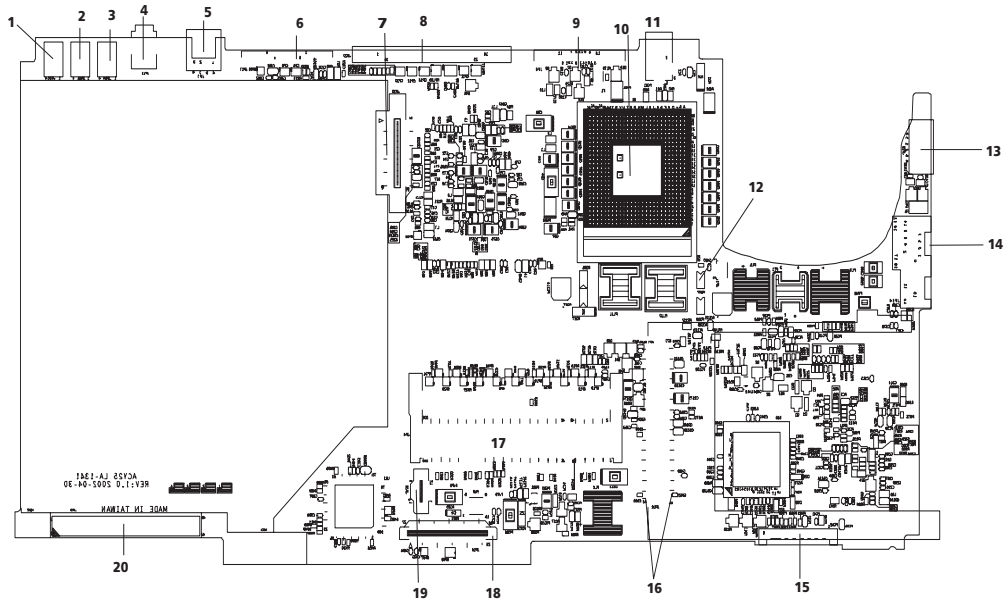

1-JP31	USB connector	12-JP1	CPU fan connector
2-JP26	USB connector	13-JP28	Keyboard/PS2
3-JP24	USB connector	14-JP14	RJ45-11 connector
4-JP11	1394 connector	16-JP12	PCMCIA connector
5-JP7	TV-out connector	17-JP4	DDR 200P so-DIMM connector
6-JP17	Serial port	18-JP19	FDD connector
7-JP10	CD-ROM connector	19-JP30	Card reader connector
8-JP27	Parallel connector	20-JP9	HDD connector
9-JP6	CRT connector		



## FRU (Field Replaceable Unit) List

---

This chapter gives you the FRU (Field Replaceable Unit) listing in global configurations of TravelMate 270 series products. Refer to this chapter whenever ordering for parts to repair or for RMA (Return Merchandise Authorization).

Please note that WHEN ORDERING FRU PARTS, you should check the most up-to-date information available on your regional web or channel. For whatever reasons a part number change is made, it will not be noted on the printed Service Guide. For ACER AUTHORIZED SERVICE PROVIDERS, your Acer office may have a DIFFERENT part number code from those given in the FRU list of this printed Service Guide. You MUST use the local FRU list provided by your regional Acer office to order FRU parts for repair and service of customer machines.

**NOTE:** To scrap or to return the defective parts, you should follow the local government ordinance or regulations on how to dispose it properly, or follow the rules set by your regional Acer office on how to return it.



# Exploded Diagram

## THE SYSTEM

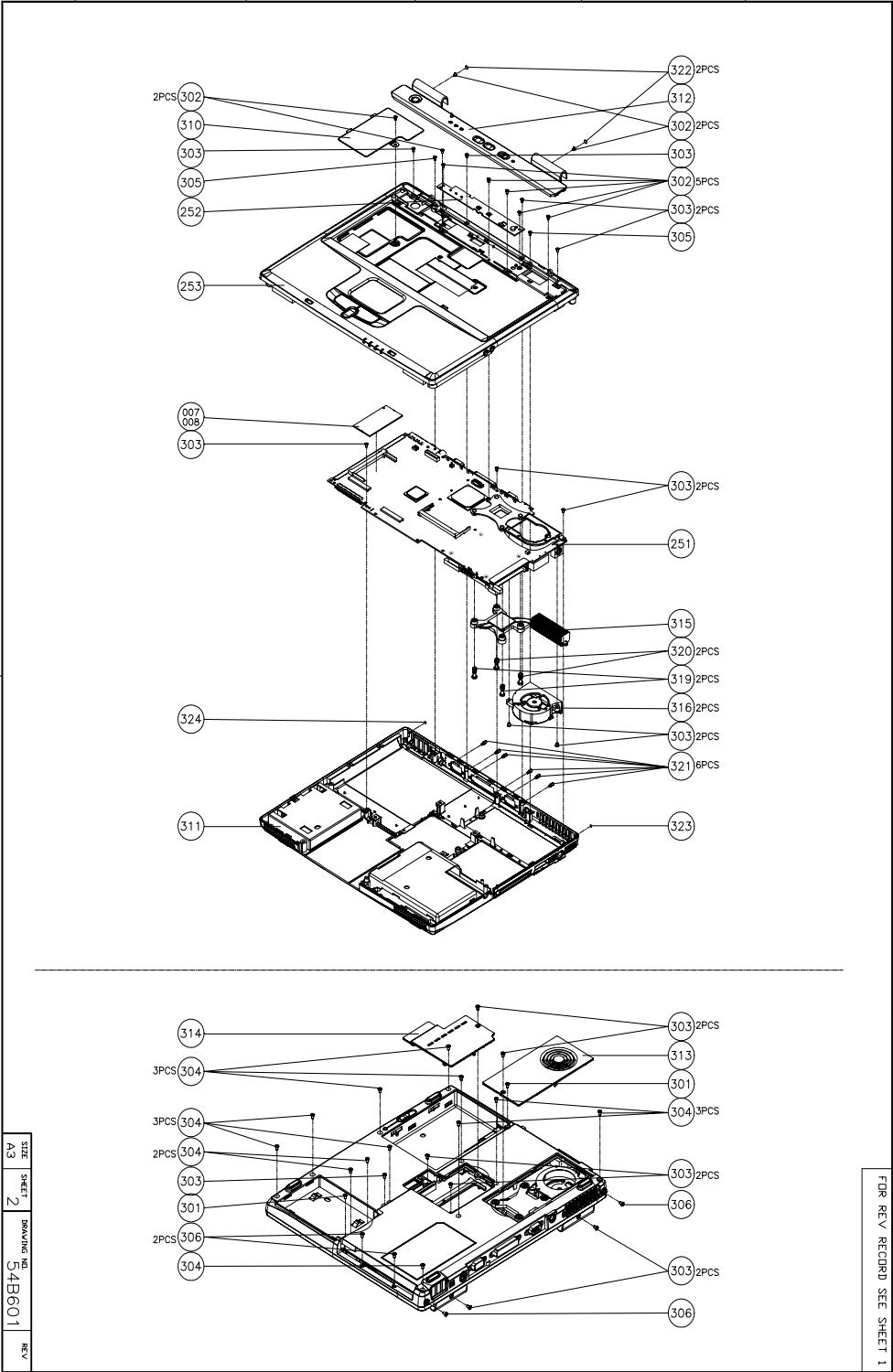

SIZE	SHEET	DRAWING NO.	REV.
A3	2	54B601	

FOR REV RECORD SEE SHEET 1

# LOGIC UPPER ASSY

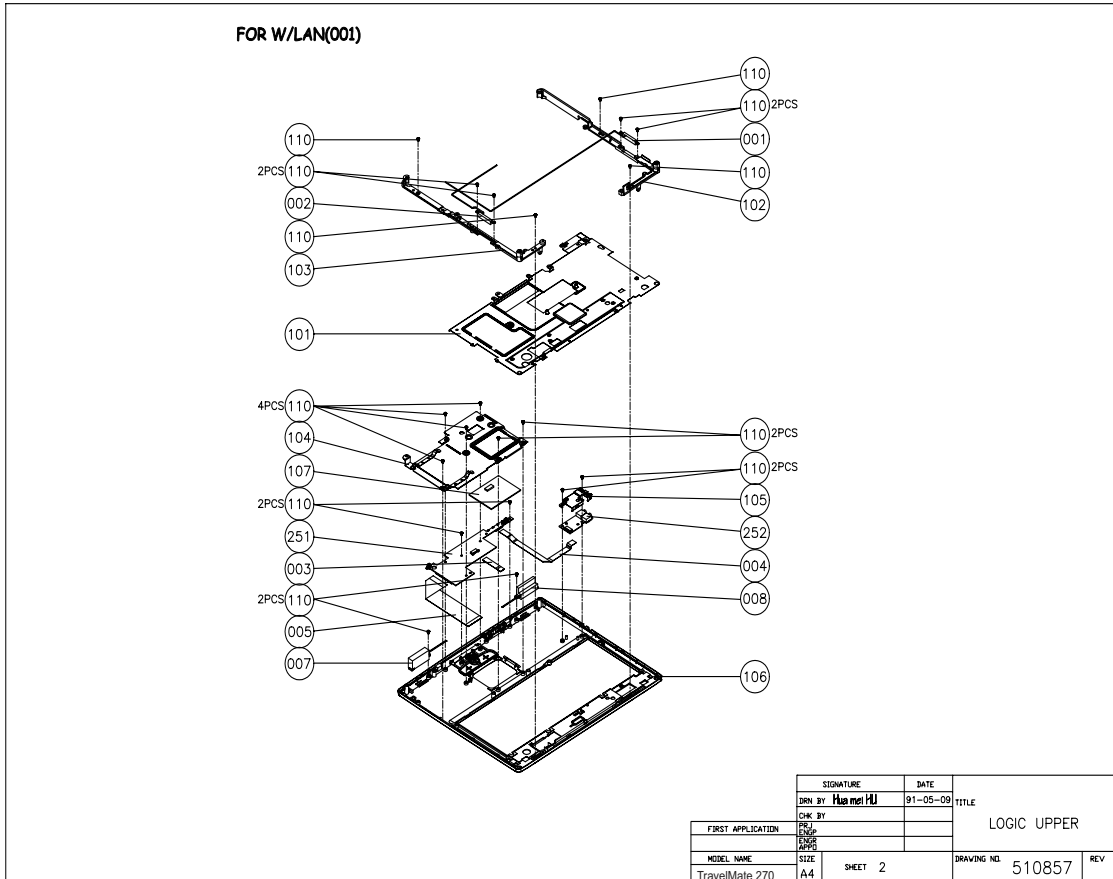

# LCD 14.1"

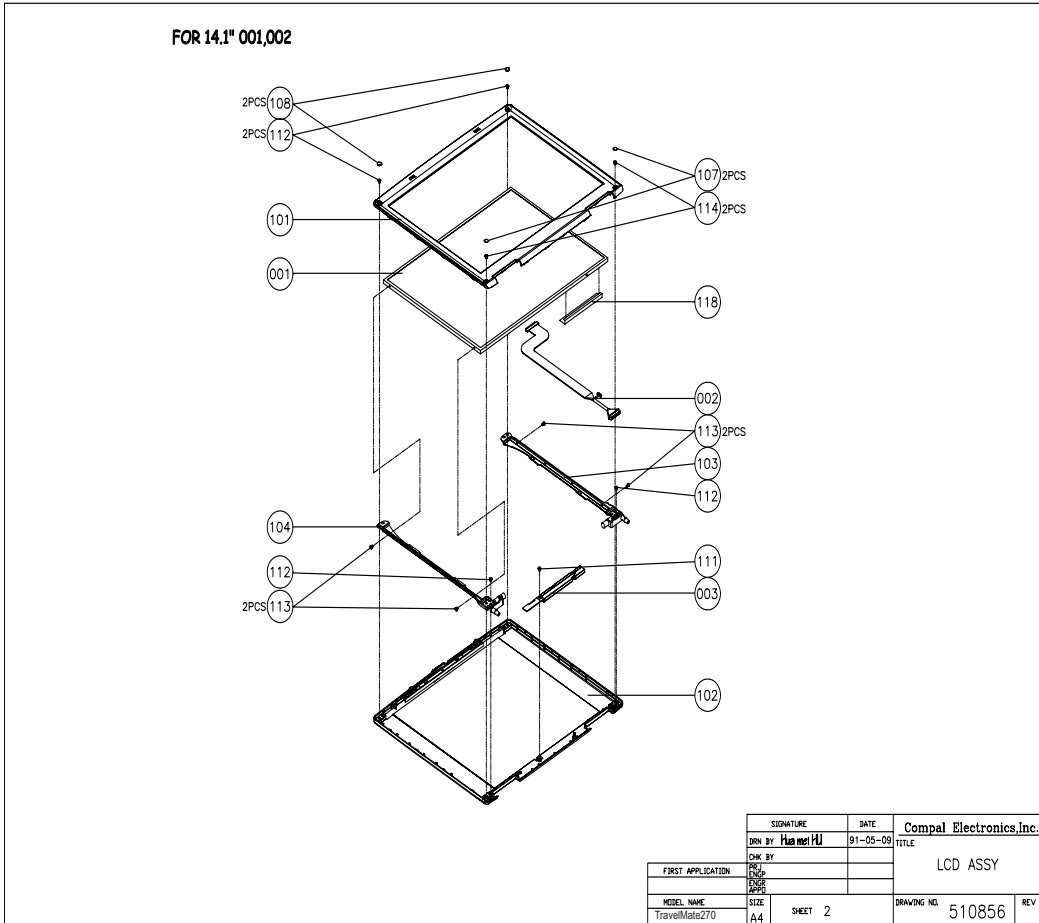

# LCD 15"

FOR 15" 011,012,013,021,022,023

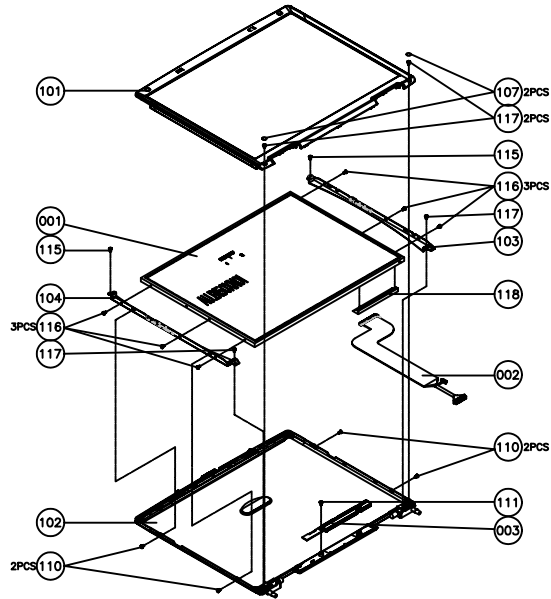

SIGNATURE		DATE	TITLE	
CHK BY: Plus met PJ		01-05-00	LCD ASSY	
FIRST APPLICATION				
MODEL NAME		TRAVELMATE 270	DRAWING NO. 510856	
SIZE		A4	REV	
		SHEET 3		

# DVD ASSY

FOR 003

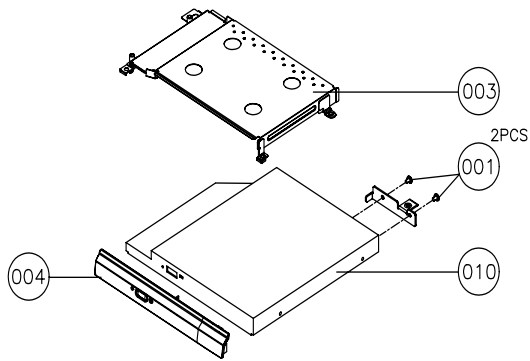

SIGNATURE		DATE	TITLE	
DRN BY: <i>Hua mei HU</i>		01-03-06	DVD ASSY	
FIRST APPLICATION	CHK BY	ENG	APPV	
MODEL NAME	SIZE	SHEET 3		DRAWING NO. 510853
TravelMate 270	A4			REV





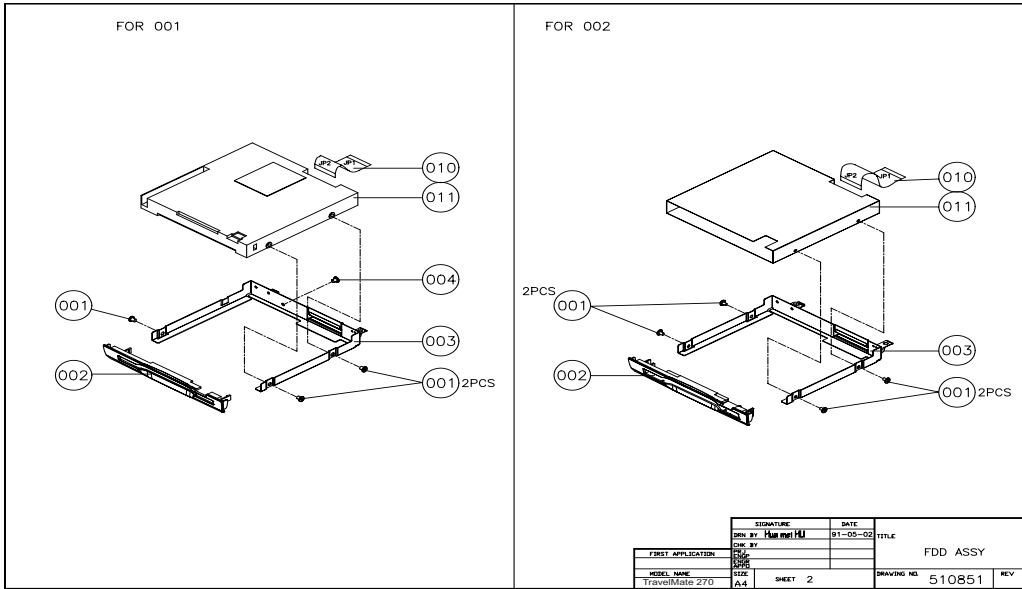

**NOTE:** The exploded diagrams for CD-ROM, DVD-ROM and DVD-RW combo module are very similar. Therefor, we put only DVD ASSY exploded diagram for your reference. Please also refer to the FRU list below for more information on different models and part numbers. This diagram only explains the relevant location of each part. The parts on the exploded diagrams may be a slightly different from its actual looks.

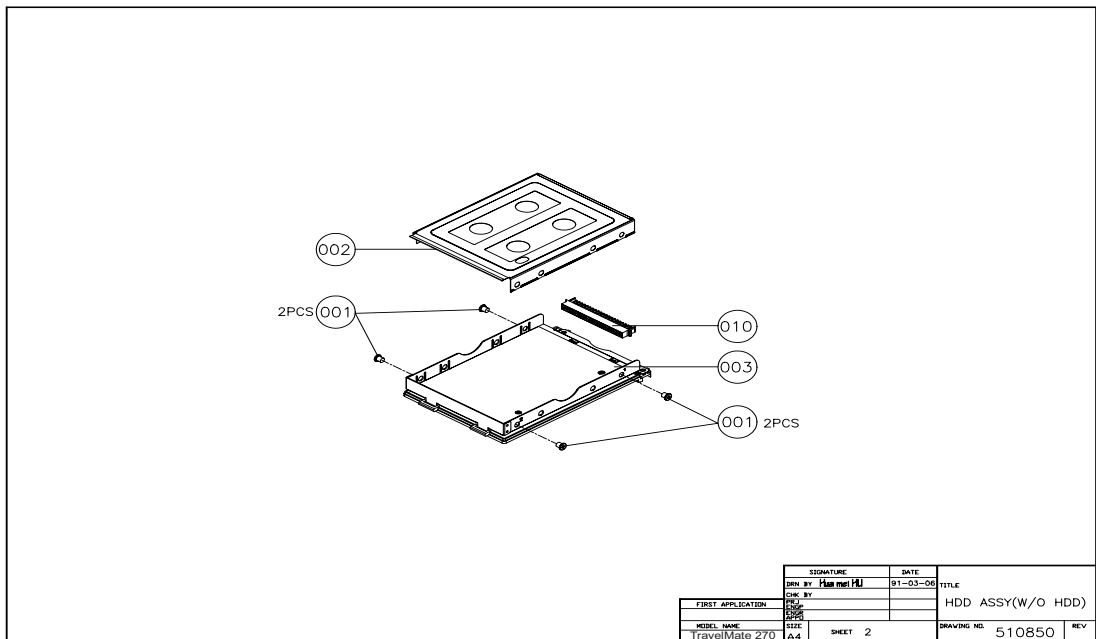





# FDD ASSY



# HDD (W/O HDD) ASSY









Picture	No.	Partname And Description	Part Number
<b>Adapter</b>			
	NS	ADAPTER-DELTA 70W (3Pin)	AP.17001.001
		ADAPTER-ASTEC	AP.80304.002
<b>Battery</b>			
	NS	BATTERY LI-ION 8 CELL-PANASONIC	HBT.0186.001
		BATTERY LI-ION 8 CELL-SAMSUNG	HBT.0186.002
<b>Boards</b>			
	251-Logic Upper	AUDIO/TOUCHPAD BOARD	55.T18V5.001
	252-The system	SWITCH BOARD	55.T18V5.002
	252-Logic Upper	PHONE JACK BOARD	55.T18V5.003
	NS	MODEM CARD	54.T18V5.001
	NS	WIRELESS LAN COMBOCARD	54.T18V5.002
<b>Cables</b>			
	016-Logic Upper	FFC-AUDIO 30 PIN	50.T18V5.001





Picture	No.	Partname And Description	Part Number
	003-Logic Upper	FFC-TOUCHPAD	50.T18V5.002
	004-Logic Upper	FFC-PHONE JACK	50.T18V5.003
	NS	CABLE-MODEM	50.T18V5.004
	002-Logic Upper	ANTENNA LINE-L Note: The shorter one is the left antenna line	50.T18V5.005
	001-Logic Upper	ANTENNA LINE-R Note: The longer one is the right antenna line	50.T18V5.006
	NS	POWER CORD US (3Pin)	27.T18V5.001
		POWER CORD EC (3Pin)	27.T18V5.002
		POWER CORD Aus (3Pin)	27.T18V5.003
		POWER CORD UK (3Pin)	27.T18V5.004
		POWER CORD SWISS (3Pin)	27.T18V5.005
		POWER CORD CHINA (3Pin)	27.T18V5.006
		POWER CORD ITALLIAN (3Pin)	27.T18V5.007
		POWER CORD DEMARK (3Pin)	27.T18V5.008
<b>Case/Cover/Bracket Assembly</b>			
	312-The System	MIDDLE COVER	42.T18V5.001
NS	322-The System	MIDDLE COVER SCREW PAD	47.T18V5.003

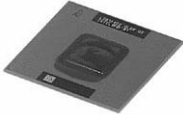









Picture	No.	Partname And Description	Part Number
	314-The System	DIMM COVER	42.T18V5.002
	313-The System	HEATSINK COVER	42.T18V5.003
	311-The System	LOWER CASE W/O SPEAKER-INCLUDING BATTER LATCH, NOB, SPRING	60.T18V5.001
	253-The System	UPPER CASE W/O TOUCHPAD COVER	60.T18V5.002
	101-Logic Upper	EMI SHIELDING WITH MYLARS, THERMAL PAD	60.T18V5.003
	310-The System	MINI PCI EMI SHIELDING	31.T18V5.001
	003-DVD ASSY	OPTICAL BRACKET	33.T18V5.001





Picture	No.	Partname And Description	Part Number
	104-Logic Upper	TOUCHPAD BRACKET	33.T18V5.002
	NS	TOUCHPAD COVER	42.T18V5.004
	NS	CPU SUPPORT BRACKET	33.T18V5.003
	102-Logic Upper	HINGE SADDLE-R	34.T18V5.001
	103-Logic Upper	HINGE SADDLE-L	34.T18V5.002
	105-Logic Upper	PHONE JACK COVER	42.T18V5.005
		BATTERY LATCH/KNOB KIT including battery spring, knob, latch, latch cover	6K.T18V5.001
CPU			
	NS	INTEL PENTIUM 4 1.4GHZ/400FSB	01.ORTH.1G4
		INTEL PENTIUM 4 1.5GHZ/400FSB	01.ORTH.1G5
		INTEL PENTIUM 4 1.6GHZ/400FSB	01.ORTH.1G6
		INTEL PENTIUM 4 1.7GHZ/400FSB	01.ORTH.1G7
		INTEL PENTIUM 4 1.8GHZ/400FSB	01.ORTH.1G8
FDD/Floppy Disk Drive			

Picture	No.	Partname And Description	Part Number
	FDD ASSY	FDD MODULE, PANASONIC	6M.T18V5.010
		FDD MODULE, MITSUMI	6M.T18V5.011
	011-FDD ASSY	FDD DRIVE PANASONIC	KF.22602.001
		FDD DRIVE MITSUMI	KF.35301.002
	002-FDD ASSY	FDD DOOR PANASONIC	42.T18V5.016
		FDD DOOR MITSUMI	42.T18V5.017
	001-FDD ASSY	FDD BRACKET PANASONIC	33.T18V5.004
		FDD BRACKET MITSUMI	33.T18V5.005
	010-FDD ASSY	FDD FPC PANASONIC	50.T18V5.007
		FDD FPC MITSUMI	50.T18V5.008
<b>HDD/ Hard Disk Drive</b>			
	NS	HDD 2.5" 20G IBM CASCADE IC25N020ATCS04-0 07N8325 FW: A71A	KH.25202.001
		HDD 2.5" 30G IBM CASCADE IC25N030ATCS04-0 07N8326 FW: A71A	KH.25302.001
		HDD 2.5" 40G IBM CASCADE IC25N040ATCS04-0 07N8326 FW: A71A	KH.25402.001
		HDD 2.5" TOSHIBA 20GB TITAN MK2018GAP 4200RPM	KH.25204.001
		HDD 2.5" TOSHIBA 30GB TITAN MK3018GAP 4200RPM	KH.25304.001
		HDD 2.5" TOSHIBA 40GB TITAN MK4018GAP 4200RPM	KH.25404.001
		HDD 2.5" 20G Hitachi DK23DA-20F	KH.32005.001
		HDD 2.5" 30G Hitachi DK23DA-30F	KH.33005.001
		HDD 2.5" 40G Hitachi DK23DA-40F	KH.34005.001
	003-HDD (W/O HDD) ASSY	HDD CARRIER	42.T18V5.018
	010-HDD (W/O HDD) ASSY	HDD CONNECTOR	22.T18V5.002

Picture	No.	Partname And Description	Part Number
	002-HDD (W/O HDD) ASSY	HDD BRACKET COVER	33.T18V5.006
<b>Keyboard</b>			
	NS	AS1400 KEYBOARD CHICONY Arabic	KB.T1802.010
		AS1400 KEYBOARD CHICONY Belgium	KB.T1802.012
		AS1400 KEYBOARD CHICONY Traditional Chiese	KB.T1802.005
		AS1400 KEYBOARD CHICONY Czech	KB.T1802.014
		AS1400 KEYBOARD CHICONY Danish	KB.T1802.017
		AS1400 KEYBOARD CHICONY French	KB.T1802.006
		AS1400 KEYBOARD CHICONY German	KB.T1802.003
		AS1400 KEYBOARD CHICONY Hungaian	KB.T1802.015
		AS1400 KEYBOARD CHICONY Japan	KB.T1802.004
		AS1400 KEYBOARD CHICONY Norwegian	KB.T1802.016
		AS1400 KEYBOARD CHICONY Portuguese	KB.T1802.009
		AS1400 KEYBOARD CHICONY Swedish	KB.T1802.013
		AS1400 KEYBOARD CHICONY Spanish	KB.T1802.008
		AS1400 KEYBOARD CHICONY Swiss/G	KB.T1802.007
		AS1400 KEYBOARD CHICONY Thai	KB.T1802.011
		AS1400 KEYBOARD CHICONY Turkish	KB.T1802.018
AS1400 KEYBOARD CHICONY UK	KB.T1802.002		
AS1400 KEYBOARD CHICONY US-International	KB.T1802.001		
<b>LCD</b>			
	LCD 14.1" and LCD 15"	ASSY LCD MODULE 14.1" XGA AU	6M.T18V5.012
		ASSY LCD MODULE 14.1" XGA CPT	6M.T18V5.013
		ASSY LCD MODULE 15.0" XGA AU	6M.T18V5.014
		ASSY LCD MODULE 15.0" XGA LG	6M.T18V5.015
		ASSY LCD MODULE 15.0" XGA HITACHI	6M.T18V5.016
		ASSY LCD MODULE 15.0" SXGA+ CPT	6M.T18V5.017
		ASSY LCD MODULE 15.0" SXGA+ LG	6M.T18V5.018
		ASSY LCD MODULE 15.0" SXGA+ IBM	6M.T18V5.019
	001-LCD 14.1" and LCD 15"	LCD 14.1" TFT XGA UB141X03 (AU)	LK.A0205.001
		LCD 14.1" TFT XGA LTN141XF-L05 (SAMSUNG)	LK.A0206.001
		LCD 15.0" TFT XG (AU)AB150XN01	LK.A0205.002
		LCD 15.0" TFT XGA HSD150PX11-B(HANNSTAR)	LK.A0207.001

Picture	No.	Partname And Description	Part Number
	003-LCD 14.1" and LCD 15"	LCD INVERTER	19.T18V5.001
	104-LCD 14.1" and LCD 15	LCD BRACKET L14" for AU, CPT Note: The brackets you see on the exploded diagram are with hinges.	33.T18V5.006
		LCD BRACKET L15" XGA AU	33.T18V5.008
		LCD BRACKET L15" XGA LG	33.T18V5.014
		LCD BRACKET L15" XGA HITACHI	33.T18V5.010
	103-LCD 14.1" and LCD 15"	LCD BRACKET L15" SXGA+ for CPT, LG, IBM	33.T18V5.012
		LCD BRACKET R14" for AU, CPT Note: The brackets you see on the exploded diagram are with hinges.	33.T18V5.007
		LCD BRACKET R15" XGA AU	33.T18V5.009
		LCD BRACKET R15" XGA LG	33.T18V5.015
	102-LCD 14.1" and LCD 15"	LCD BRACKET R15" XGA HITACHI	33.T18V5.011
		LCD BRACKET R15" SXGA+ for CPT, LG, IBM	33.T18V5.013
		LCD PANEL WITH LOGO-14"	60.T18V5.004
		LCD PANEL WITH LOGO-15"	60.T18V5.006
			
	NS	LCD KNOB LATCH KIT	6K.T18V5.002
	NS	LCD HINGE ASSEMBLY (L&R) for 15" LCD	6K.T18V5.003
	101-LCD 14.1" and LCD 15"	LCD BEZEL 14.1"	60.T18V5.005
		LCD BEZEL WITH RUBBER-15.0"	60.T18V5.007

Picture	No.	Partname And Description	Part Number
	002-LCD 14.1" and LCD 15"	WIRE SET 14.1" XGA AU	50.T18V5.009
		WIRE SET 14.1" XGA CPT	50.T18V5.010
		WIRE SET 15.0" XGA AU	50.T18V5.011
		WIRE SET 15.0" XGA LG	50.T18V5.012
		WIRE SET 15.0" XGA HITACHI	50.T18V5.013
		WIRE SET 15.0" SXGA+ CPT	50.T18V5.014
		WIRE SET 15.0" SXGA+ LG	50.T18V5.015
	WIRE SET 15.0" SXGA+ IBM	50.T18V5.016	
	108-14.1" LCD	LCD RUBBER for 14.1" LCD	47.T18V5.001
	107-14.1" LCD	LCD SCREW PAD	47.T18V5.002
<b>Main Board</b>			
	251-The System	MAINBOARD W/ PCMCIA SLOT, MODEM CABLE (W/O CPU MEMORY)	MB.T1802.001
	NS	PCMCIA SLOT	21.T18V5.001
<b>Memory</b>			
	NS	128MB SO-DIMM DDR NT128D64S88A2GM-7K Nanya	KN.12803.002
		SO-DDR 128MB HYS64D16020GDL-7-A 8Mx16*8 Infineon	KN.12802.002
		128MB SO-DIMM UNB PC2100 CL2.5 Apacer	77.10921.580
		256MB SO-DIMM DDR NT256D64S88A2GM-7K Nanya	KN.25603.003
		SO-DDR 256MB HYS64D32020GDL-7-B 32Mx8*8 Infineon	KN.25602.001
		256MB SO-DIMM UNB PC2100 CL2.5 Apacer	77.11021.580
<b>Optical Drive</b>			
	DVD ASSY	CD-ROM MODULE 24X QSI	6M.T18V5.001
		CD-ROM MODULE 24X SAMSUNG	6M.T18V5.002
		DVD-ROM MODULE 8X TOSHIBA	6M.T18V5.005
		DVD-ROM MODULE 8X HLDS	6M.T18V5.006
		DVD-ROM MODULE 8X LITEON	6M.T18V5.007
		DVD-RW COMBO MODULE TOSHIBA	6M.T18V5.008
		DVD-RW COMBO MODULE KME	6M.T18V5.009

Picture	No.	Partname And Description	Part Number
	101-DVD ASSY	CD-ROM DRIVE 24X QSI (SCR-242-S)	KD.24X03.001
		CD-ROM DRIVE 24X SAMSUNG (SN-124P)	KD.24X02.001
		DVD-ROM DRIVE 8X TOSHIBA (SD-2612)	KV.08X01.001
		DVD-ROM DRIVE 8X HLDS (GDR-8081N)	KD.80803.001
		DVD-ROM DRIVE 8X LITEON (LSD-081)	KV.08X04.001
		DVD-RW COMBO DRIVE 8X TOSHIBA (SD-R2212)	KO.08X04.001
		DVD-RW COMBO DRIVE 8X KME (UJDA730CP)	KO.08X03.001
	NS	OPTICAL LOCK	22.T18V5.001
Others			
	007-Logic Upper	SPEAKER-R	23.T18V5.002
	008-Logic Upper	SPEAKER-L	23.T18V5.003
	107-Logic Upper	TOUCHPAD (BACK SIDE)	56.T18V5.001
	NS	FAN	31.T18V5.001
	315-The System	HEATSINK	23.T18V5.001
	NS	MIDDLE COVER NAME PLATE	40.T18V5.001

Picture	No.	Partname And Description	Part Number
Screws			
		CPU FRAME NUT	86.T18V5.001
		Screw, #4-40UNF	86.T18V5.002
		Screw, M2.0*2.5 NL	86.T18V5.003
		Screw, M2.0*3	86.T18V5.004
		Screw, M2.0*3 NL	86.T18V5.005
		Screw, M2.0*5	86.T18V5.006
		Screw, M2.0*7	86.T18V5.007
		Screw, M2.5*12	86.T18V5.009
		Screw, M2.5*182	86.T18V5.010
		Screw, M2.5*3 NL	86.T18V5.011
		Screw, M2.5*4	86.T18V5.012
		Screw, M2.5*5	86.T18V5.013
		Screw, M2.5*7 NL	86.T18V5.014
		Screw, M2.5*9 NL	86.T18V5.015
		Screw, M3.0*3	86.T18V5.016
		Screw, TPB-1.7 3.5P-ZK(NL)	86.T18V5.017
		THERMAL SCREW WITH SPRING	86.T18V5.018
		THERMAL SCREW WITH WHITE SPRING	86.T18V5.019



## Model Definition and Configuration

---

### TravelMate 270 Series

Model Number	CPU	LCD	ODD	Memory	HDD (GB)
270X	P4-1400 uFCPGA2	14.1 XGA	24X CD	128	20
270XV	P4-1400 uFCPGA2	14.1 XGA	8X DVD	128	20
270XVi	P4-1400 uFCPGA2	14.1 XGA	8X DVD	256	20
270XC	P4-1400 uFCPGA2	14.1 XGA	8/8/8/24 combo	120	20
272X	P4-1600 uFCPGA2	14.1 XGA	24X CD	256	20
272XV	P4-1600 uFCPGA2	14.1 XGA	8X DVD	256	20
272XVi	P4-1600 uFCPGA2	14.1 XGA	8X DVD	256	20
272XC	P4-1600 uFCPGA2	14.1 XGA	8/8/8/24 combo	256	20
272LC	P4-1600 uFCPGA2	15.0 XGA	8/8/8/24 combo	256	30
273XV	P4-1700 uFCPGA2	14.1 XGA	8X DVD	256	20
273XC	P4-1700 uFCPGA2	14.1 XGA	8/8/8/24 combo	256	20

---

## Main Features

- ❑ Mobile Intel® Pentium® Processor-M at 1.4GHz or higher, featuring Intel® Enhanced SpeedStep™ technology
- ❑ SiS 650 chipset with embedded VGA, featuring 16MB DDR shared video memory (default, or 32/64MB configurable through BIOS setup)
- ❑ Standard 128/256MB of DDR-266 SDRAM, upgradeable to 1024MB on dual SoDIMM sockets
- ❑ 14.1" or 15.0" XGA TFT colour LCD, 1024x768 pixel resolution, 16.7 million colours
- ❑ 20GB or higher Ultra DMA-100 removable HDD
- ❑ 1.44" floppy disk drive or optional 4-in-1 card reader (depending on availability)
- ❑ Optical drive bay for optional 24X CD-ROM, 8X DVD-ROM or 8X DVD/24X (8/8/24) CD-RW combo drive
- ❑ Embedded 10/100Mbps Fast Ethernet; optional Acer InviLink™ IEEE 802.11b wireless LAN with internal antenna
- ❑ International 56K ITU V.90 data/fax software modem (Wake-on-Ring ready)
- ❑ ACPI 2.0 power management; 57Wh li-ion battery pack; 3-hour battery life<sup>1</sup>; 3-hour rapid-charge, 6-hour charge-in-use
- ❑ FineTouch keyboard with 5° curve; built-in touchpad pointing device with integrated scroll key; 5 launch keys and 3 programmable keys; InviLink™ button for wireless models

---

<sup>1</sup> Actual battery life may be different because of the usage and configuration.



## Test Compatible Components

---

This computer's compatibility is tested and verified by Acer's internal testing department. All of its system functions are tested under Windows® XP Home, Windows® XP Pro and Windows® 2000 environment.

Refer to the following lists for components, adapter cards, and peripherals which have passed these tests. Regarding configuration, combination and test procedures, please refer to the TravelMate 270 series Compatibility Test Report released by the Acer Mobile System Testing Department.

# Microsoft® Windows® XP Home Environment Test

Item	Specifications
Display	LCD 14.1" TFT (XGA)-- AU UB141X03 CPT CLAA141XF01 LCD15.0" TFT (1024x768 XGA)-- AU B150XN01 LG LP150X04 HITACHI TX38D85VC1CAB LCD 15.0" TFT (1024x768 SXGA+)-- CPT CLAA105PA01 LG LP150E01-A2M2 IBM ITSX95C
Video	Viewsonic 17PS Sony MultiScan G200 DELL Ultra Scan P991 Ext TV
Ethernet	D-Link Ethernet Adapter
Audio	
Headphone	General headphone
Microphone	General MIC
Speaker	Panasonic EAB-MPC57USB
FDD	1.44MB floppy disk drive
I/O Peripheral	
I/O - printer (parallel)	HP LaserJet 5P HP LaserJet 2100 PCL6(IR) EPSON color 740
I/O - TV	Sony KV-W32MX2
I/O - Keyboard	Darfon Natural USB keyboard Pro Chicony KU-8933 USB keyboard
I/O - USB	JAZ 2GB Iomega ZIP 100 USB HDD MITSUMI USB FDD
I/O - USB (Mouse)	Logitech M-BD58 Logitech M-UA34 Logitech M-UB48 Microsoft IntelliMouse Explorer
I/O - USB (Speaker)	Panasonic EAB-MPC57USB
I/O - USB (Camera)	Intel PC Camera Pro Pack
I/O - USB (ZIP)	Iomega ZIP 100
I/O - USB (HUB)	BELKIN Express Bus HUB D-LINK HUB

Item	Specifications
Com port & PS/2	Logitech M-M35 Logitech Trackman Marble T-CJ12 Logitech Trackman Portable Mouse T-CC3 Logitech MouseMan M-CV46 Logitech Track Man Live (W/L) M-RD37 Microsoft Intellimouse Microsoft Home Mouse
I/O Adapter	
PCMCIA	Xircom 32-bit Card bus 10/100 Com 32-bit Card bus 10/100 BASE-TX (3C575-TX) Xircom Ethernet 10/100+Modem 56K(CBEM56G-100) Xircom RealPort Card Ethernet 10/100+ Modem56(RBEM56G-100) Toshiba Type II PCMCIA 2G HDD 3COM Airconnect(3CRWE737A) wireless LAN card Cisco Aironet 340(AIR-PCM340)wireless LAN card Iomega Klik! PC Card 40MB LEXAR Compact Flash Card (16MB) RITEK Compact Flash Memory (128MB) HITACHI CompactFlash Memory (64MB) DELL IEEE 1394a PC Card

# Microsoft® Windows® XP Pro Environment Test

Item	Specifications
Display	LCD 14.1" TFT (XGA)-- AU UB141X03 CPT CLAA141XF01 LCD15.0" TFT (1024x768 XGA)-- AU B150XN01 LG LP150X04 HITACHI TX38D85VC1CAB LCD 15.0" TFT (1024x768 SXGA+)-- CPT CLAA105PA01 LG LP150E01-A2M2 IBM ITSX95C
Video	Viewsonic 17PS Sony MultiScan G200 DELL Ultra Scan P991 Ext TV
Ethernet	D-Link Ethernet Adapter
Audio	
Headphone	General headphone
Microphone	General MIC
Speaker	Panasonic EAB-MPC57USB
FDD	1.44MB floppy disk drive
I/O Peripheral	
I/O - printer (parallel)	HP LaserJet 5P HP LaserJet 2100 PCL6(IR) EPSON color 740
I/O - TV	Sony KV-W32MX2
I/O - Keyboard	Darfon Natural USB keyboard Pro Chicony KU-8933 USB keyboard
I/O - USB	JAZ 2GB Iomega ZIP 100 USB HDD MITSUMI USB FDD
I/O - USB (Mouse)	Logitech M-BD58 Logitech M-UA34 Logitech M-UB48 Microsoft IntelliMouse Explorer
I/O - USB (Speaker)	Panasonic EAB-MPC57USB
I/O - USB (Camera)	Intel PC Camera Pro Pack
I/O - USB (ZIP)	Iomega ZIP 100
I/O - USB (HUB)	BELKIN Express Bus HUB D-LINK HUB

Item	Specifications
Com port & PS/2	Logitech M-M35 Logitech Trackman Marble T-CJ12 Logitech Trackman Portable Mouse T-CC3 Logitech MouseMan M-CV46 Logitech Track Man Live (W/L) M-RD37 Microsoft Intellimouse Microsoft Home Mouse
I/O Adapter	
PCMCIA	Xircom 32-bit Card bus 10/100 Com 32-bit Card bus 10/100 BASE-TX (3C575-TX) Xircom Ethernet 10/100+Modem 56K(CBEM56G-100) Xircom RealPort Card Ethernet 10/100+ Modem56(RBEM56G-100) Toshiba Type II PCMCIA 2G HDD 3COM Airconnect(3CRWE737A) wireless LAN card Cisco Aironet 340(AIR-PCM340)wireless LAN card lomeage Clk! PC Card 40MB LEXAR Compact Flash Card (16MB) RITEK Compact Flash Memory (128MB) HITACHI CompactFlash Memory (64MB) DELL IEEE 1394a PC Card



# Microsoft® Windows® 2000 Environment Test

Item	Specifications
Display	LCD 14.1" TFT (XGA)-- AU UB141X03 CPT CLAA141XF01 LCD15.0" TFT (1024x768 XGA)-- AU B150XN01 LG LP150X04 HITACHI TX38D85VC1CAB LCD 15.0" TFT (1024x768 SXGA+)-- CPT CLAA105PA01 LG LP150E01-A2M2 IBM ITSX95C
Video	Viewsonic 17PS Sony MultiScan G200 DELL Ultra Scan P991 Ext TV
Ethernet	D-Link Ethernet Adapter
Audio	
Headphone	General headphone
Microphone	General MIC
Speaker	Panasonic EAB-MPC57USB
FDD	1.44MB floppy disk drive
I/O Peripheral	
I/O - printer (parallel)	HP LaserJet 5P HP LaserJet 2100 PCL6(IR) EPSON color 740
I/O - TV	Sony KV-W32MX2
I/O - Keyboard	Darfon Natural USB keyboard Pro Chicony KU-8933 USB keyboard
I/O - USB	JAZ 2GB Iomega ZIP 100 USB HDD MITSUMI USB FDD
I/O - USB (Mouse)	Logitech M-BD58 Logitech M-UA34 Logitech M-UB48 Microsoft IntelliMouse Explorer
I/O - USB (Speaker)	Panasonic EAB-MPC57USB
I/O - USB (Camera)	Intel PC Camera Pro Pack
I/O - USB (ZIP)	Iomega ZIP 100
I/O - USB (HUB)	BELKIN Express Bus HUB D-LINK HUB

Item	Specifications
Com port & PS/2	Logitech M-M35 Logitech Trackman Marble T-CJ12 Logitech Trackman Portable Mouse T-CC3 Logitech MouseMan M-CV46 Logitech Track Man Live (W/L) M-RD37 Microsoft Intellimouse Microsoft Home Mouse
I/O Adapter	
PCMCIA	Xircom 32-bit Card bus 10/100 Com 32-bit Card bus 10/100 BASE-TX (3C575-TX) Xircom Ethernet 10/100+Modem 56K(CBEM56G-100) Xircom RealPort Card Ethernet 10/100+ Modem56(RBEM56G-100) Toshiba Type II PCMCIA 2G HDD 3COM Airconnect(3CRWE737A) wireless LAN card Cisco Aironet 340(AIR-PCM340)wireless LAN card lomeage Clk! PC Card 40MB LEXAR Compact Flash Card (16MB) RITEK Compact Flash Memory (128MB) HITACHI CompactFlash Memory (64MB) DELL IEEE 1394a PC Card



## Online Support Information

---

This section describes online technical support services available to help you repair your Acer Systems.

If you are a distributor, dealer, ASP or TPM, please refer your technical queries to your local Acer branch office. Acer Branch Offices and Regional Business Units may access our website. However some information sources will require a user i.d. and password. These can be obtained directly from Acer CSD Taiwan.

Acer's Website offers you convenient and valuable support resources whenever you need them.

In the Technical Information section you can download information on all of Acer's Notebook, Desktop and Server models including:

- Service guides for all models
- User's manuals
- Training materials
- Main manuals
- Bios updates
- Software utilities
- Schematics
- Spare parts lists
- Chips
- TABs (Technical Announcement Bulletin)

The service repair section provides you with downloadable information on:

- Troubleshooting guides
- Tooling box information
- Repair instructions for specific models
- Basic repair guidelines
- Debug cards for Acer's latest models

For these purposes, we have included an Acrobat File to facilitate the problem-free downloading of our technical material.

Also contained on this website are:

- Detailed information on Acer's International Traveler's Warranty (ITW)
- Returned material authorization procedures
- An overview of all the support services we offer, accompanied by a list of telephone, fax and email contacts for all your technical queries.

We are always looking for ways to optimize and improve our services, so if you have any suggestions or comments, please do not hesitate to communicate these to us.



**A**

- AC Adapter 31
- ACPI 1.0a 23
- AFLASH Utility 47
- Audio 26, 27

**B**

- Battery 28
- Battery Pack 57
- battery pack
  - charging indicator 12
- BIOS 23
  - package 23
  - password control 23
  - ROM size 23
  - ROM type 23
  - vendor 23
  - Version 23
- BIOS Setup Utility 35
- BIOS Supports protocol 23
- BIOS Utility 35
  - Basic System Settings 39
  - Navigating 35
  - Onboard Device Configuration 41
  - Startup Configuration 40
  - System Information 37
  - System Security 45, 46
- Board Layout 4
  - Bottom View 5
  - Top View 4

**C**

- Cache
  - controller 23
  - size 23
- caps lock
  - on indicator 12
- CardBus 27
- computer
  - on indicator 12
- Core logic 27
- CPU
  - core voltage 23
  - package 23
  - type 23

**D**

- DIMM 23
  - Combinations 24
    - external 58
    - package 23
    - removing 58
  - Speed 23
  - voltage 23
- Disassembly
  - Battery Pack 55
  - CD-ROM/DVD-ROM Module 63
  - Floppy Disk Drive 66
  - Machine 53
  - Procedure Flowchart 55
- Display 3
- DVD-ROM Interface 25

**E**

- Error Symptom-to-Spare Part Index 75
- External CD-ROM Drive Check 70

**F**

- Features 1
- features 107
- Flash Utility 47
- Floppy Disk
  - removing the 66
- Floppy Disk Drive Interface 24
- FRU (Field Replaceable Unit) List 89

**H**

- Hard disk 24, 27
- HDD 24, 27
- Hot Keys 13

**I**

- Indicators 12
- Intermittent Problems 81

**J**

- Jumper and Connector Locations 85
  - Top View 85
  - Bottom View 87

---

## K

Keyboard 27  
Keyboard or Auxiliary Input Device Check 71

## L

L2 cache 23  
LAN/Modem Combo 24

## M

Machine Disassembly 53  
media access  
    on indicator 12  
Memory Check 71  
Model Definition 106  
Modem 24  
Modem Combo Card  
    external 61

## N

num lock  
    on indicator 12

## O

Online Support Information 117

## P

Panel 6  
    Bottom 11  
    left 6  
    Rear 9  
    right 9  
Parallel Port 26  
PC Card 12, 27  
PCMCIA 27  
Pentium III 23  
Power System Check  
    Battery Pack 73  
    Power Adapter 72, 73  
Processor 23

## R

RMA 89  
RTC 27

## S

Second Level Cache 23  
Super I/O 27  
System

Block Diagram 3  
Layout 4

System Check Procedures 70  
System Diagnostic Diskette 47  
System Memory 23  
System Specifications  
    Features 107  
System Utilities 35  
System Utility Diskette 47

## T

Temperature 32  
Test Compatible Components 109  
Touchpad Check 73  
Troubleshooting 69

## U

Undetermined Problems 82  
USB 27  
utility  
    BIOS 35

## V

Video 26  
    Resolutions 26  
Video controller 27

## W

Windows 2000 Environment Test 116  
Windows XP Home Environment Test 112  
Windows XP Pro Environment Test 114