

Thank you for purchasing this Factory Service Manual CD/DVD from [servicemanuals4u.com](http://servicemanuals4u.com).

Please check out our eBay auctions for more great deals on Factory Service Manuals:

[servicemanuals4u](http://servicemanuals4u.com)

# maintenance & service guide

## Presario 1200XL Series Model XL300, XL300A, and XL300B

### Removal Sequence

This chapter provides details for removing and replacing each component of the Presario 1200XL units.

#### *Electrostatic Discharge*

When removing or replacing parts, be careful to discharge static electricity before touching the internal Notebook components. A sudden discharge of static electricity from a finger or other conductor can destroy static-sensitive devices and microcircuitry. Often the spark is neither felt nor heard, but damage occurs. An electronic device exposed to an electrostatic discharge may not seem to be affected and continue to work perfectly throughout a normal cycle. However, the discharge degrades internal layers, which reduces the operating life of the device. Networks built into many integrated circuits provide some protection; but in many cases, the discharge contains enough power to alter device parameters or melt silicon junctions.

The table below shows the amount of static electricity generated by common activities associated with servicing computers.

Event	Electrostatic Voltage		
	Relative Humidity		
	10%	40%	50%
Walking across carpet	35,000 V	15,000 V	7,500 V
Walking across vinyl floor	12,000 V	5,000 V	3,000 V
Motion of bench worker	6,000 V	800 V	400 V
Removing DIPS from plastic tubes	2,000 V	700 V	400 V
Removing DIPS from vinyl trays	11,500 V	4,000 V	2,000 V
Removing DIPS from styrofoam	14,500 V	5,000 V	3,500 V
Removing bubble pack from PCBs	26,000 V	20,000 V	7,000 V
Packing PCBs in foam-lined box	21,000 V	11,000 V	5,000 V

**CAUTION:** As little as 700 Volts can degrade Notebook components. Be sure to ground yourself before touching the Notebook or its subassemblies.

**1.800.AT.COMPAQ**

# maintenance & service guide

**Presario 1200XL Series**  
**Model XL300, XL300A, and XL300B**

## *Tool and Software Requirements*

The following items are required to service the Notebook:

- Torx T-9 screwdriver
- 5mm nut drivers (for screwlocks and standoffs)
- Small standard screwdriver
- Small Phillips screwdriver
- Diagnostics software

## *Screws*

The screws used in the Notebook are **not** interchangeable. If an incorrect screw is used during the reassembly process, it can damage the unit. Compaq strongly recommends that all screws removed during disassembly be kept with the part that was removed, then returned to their proper locations.

**Important:** As each subassembly is removed from the Notebook, place it away from the work area to prevent damage.

## *Connectors and Plastic Parts*

Plastic parts can be damaged by the use of excessive force during disassembly and reassembly. When handling plastic parts, use care. Apply pressure only at the points designated in the instructions. Most of the connectors in these Notebooks are [ZIF Connectors](#).

# maintenance & service guide

## Presario 1200XL Series Model XL300, XL300A, and XL300B

### ZIF Connector

The 1200XL Series Notebooks use zero insertion force (ZIF) connectors on the system board.

 **CAUTION:** A ZIF connector and its attached cable can be easily damaged. Handle only the connector slide when removing or replacing a cable. Never pull or twist on the cable while it is connected.

To remove a cable from a ZIF connector, lift both corners of the ZIF connector and slide the cable out simultaneously with constant light pressure.

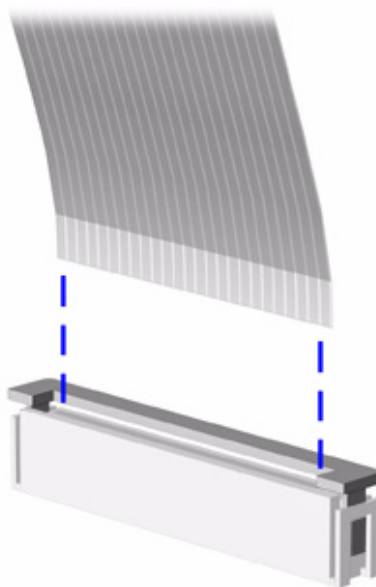

 **CAUTION:** When servicing this Notebook, ensure that cables are placed in their proper location during the reassembly process. Improper cable placement can damage the Notebook.

# maintenance & service guide

**Presario 1200XL Series**  
**Model XL300, XL300A, and XL300B**

## *Cables*

Most cables used throughout the unit are ribbon cables.

Cables must be handled with extreme care to avoid damage. Use the following precautions when handling cables to avoid damage to the cable and the Notebook:

- Always handle cables by their connectors.
- In all cases avoid bending, twisting, pulling, or tearing cables.
- Apply only the minimum pressure required to seat or unseat cables from their connectors.
- Place the cables so that they are not caught or snagged by parts being removed or replaced.
- Handle flex cables with extreme care; they can tear easily.

 **CAUTION:** When servicing these Notebooks, ensure that cables are placed in their proper location during the reassembly process. Improper cable placement can cause severe damage to the unit.

The following illustrations show the proper placement for each cable:

- [Diskette Drive Ribbon Cable](#)
- [Keyboard Ribbon Cable](#)
- [Speaker Assembly Cable](#)
- [Hard Drive Ribbon Cable](#)

# maintenance & service guide

**Presario 1200XL Series**  
**Model XL300, XL300A, and XL300B**

## Diskette Drive Ribbon Cable

The ribbon cable position for the diskette drive is shown below.



**CAUTION:** When servicing this Notebook, ensure that cables are placed in their proper location during the reassembly process. Improper cable placement can damage the Notebook.

# maintenance & service guide

**Presario 1200XL Series**  
**Model XL300, XL300A, and XL300B**

## Speaker Assembly Cable

The cable position for the speaker assembly is shown below. The cable is routed under the battery charger board and under the edge of the system board.

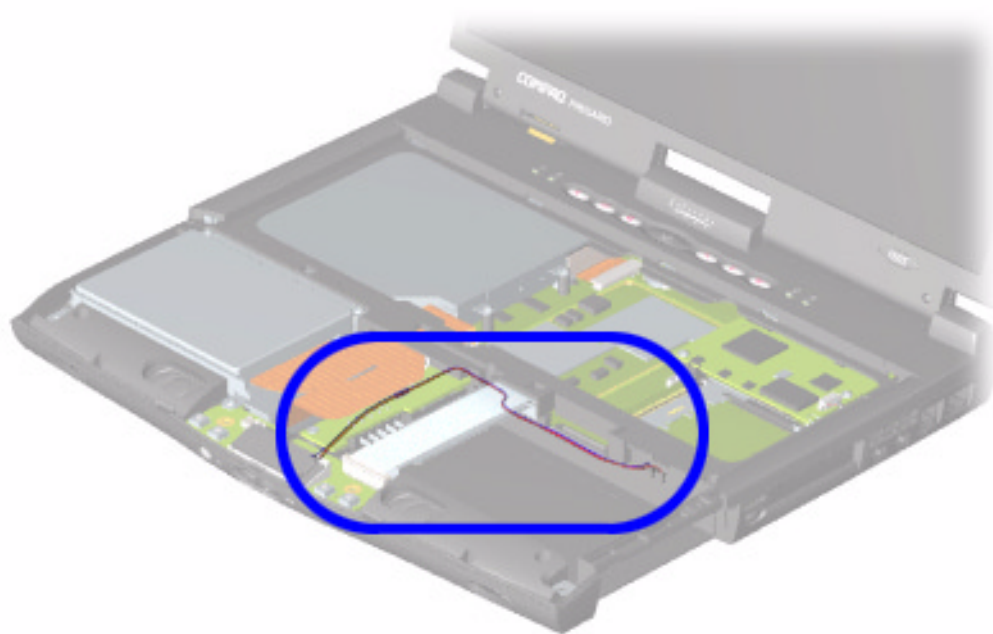

**CAUTION:** When servicing this Notebook, ensure that cables are placed in their proper location during the reassembly process. Improper cable placement can damage the Notebook.

# maintenance & service guide

**Presario 1200XL Series**  
**Model XL300, XL300A, and XL300B**

## Keyboard Ribbon Cable

The ribbon cable position for the keyboard is shown below.



**CAUTION:** When servicing this Notebook, ensure that cables are placed in their proper location during the reassembly process. Improper cable placement can damage the Notebook.



# maintenance & service guide

**Presario 1200XL Series**  
**Model XL300, XL300A, and XL300B**

## Hard Drive Ribbon Cable

The ribbon cable position for the hard drive is shown below.



**CAUTION:** When servicing the Notebook, ensure that cables are placed in their proper location during the reassembly process. Improper cable placement can damage the Notebook.

**Note:**

# maintenance & service guide

## Presario 1200XL Series Model XL300, XL300A, and XL300B

### *Preparing the Notebook for Disassembly*

Before beginning Removal and Replacement procedures, complete the following steps:

1. Disconnect AC power and any external devices.
2. Remove the battery pack ([pg 10](#)).
3. Remove any PC cards.

**Important:** The battery pack should be removed before performing any internal maintenance on the Notebook.



**WARNING:** Metal objects can damage the battery pack as well as the battery contacts in the battery compartment. To prevent damage, do not allow metal objects to touch the battery contacts. Place only the battery pack for the Compaq Presario 1200XL Series Portable Notebooks into the battery compartment. Do not force the battery pack into the bay if insertion is difficult.



**CAUTION:** Do not crush, puncture, or incinerate the battery pack. Do not open a battery pack; this action damages the pack, makes it unusable, and exposes potentially harmful battery components. No field-serviceable parts are located inside the battery pack.

**Note:** Compaq Presario 1200XL Series Portable Notebooks have several screws of various sizes that are **not** interchangeable. Care must be taken during reassembly to ensure that the correct screws are used in their correct location. During removal, keep screws with their associated respective subassembly.

# maintenance & service guide

**Presario 1200XL Series**  
**Model XL300, XL300A, and XL300B**

## *Removing the Battery*

To remove the battery pack, complete the following steps:

1. Slide ❶ the battery compartment door down and remove it from the chassis.
2. Pull ❷ the battery from the chassis by the tab located on the end of the battery pack and slide battery from the chassis.

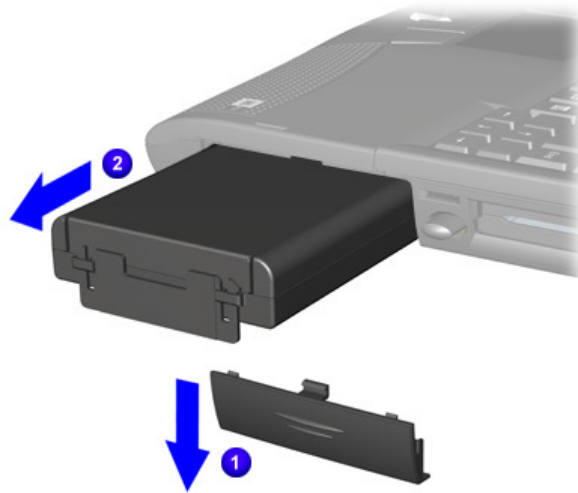

To replace the battery, reverse these procedures.

**Important:** The battery pack should be removed before performing any internal maintenance on the Notebook.

**⚠ WARNING:** Metal objects can damage the battery pack as well as the battery contacts in the battery compartment. To prevent damage, do not allow metal objects to touch the battery contacts. Place only the battery pack for Compaq Presario 1200XL Series Portable Notebooks in the battery compartment. Do not force the battery pack into the bay if insertion does not occur easily.

**⚠ CAUTION:** Do not crush, puncture, or incinerate the battery pack. Do not open a battery pack; this damages the pack, makes it unusable, and exposes potentially harmful battery components. No field-serviceable parts are located inside the battery pack.

# maintenance & service guide

**Presario 1200XL Series**  
**Model XL300, XL300A, and XL300B**

## *Removing the Modem*

To remove the modem, complete the following steps:

1. Prepare the Notebook for disassembly ([pg 9](#)).
2. Close the display, turn the Notebook upside down, and locate the modem compartment (left side when the front of the Notebook is toward you).
3. Remove one screw ❶ from the modem door, slide the door forward ❷ and then lift to remove it.

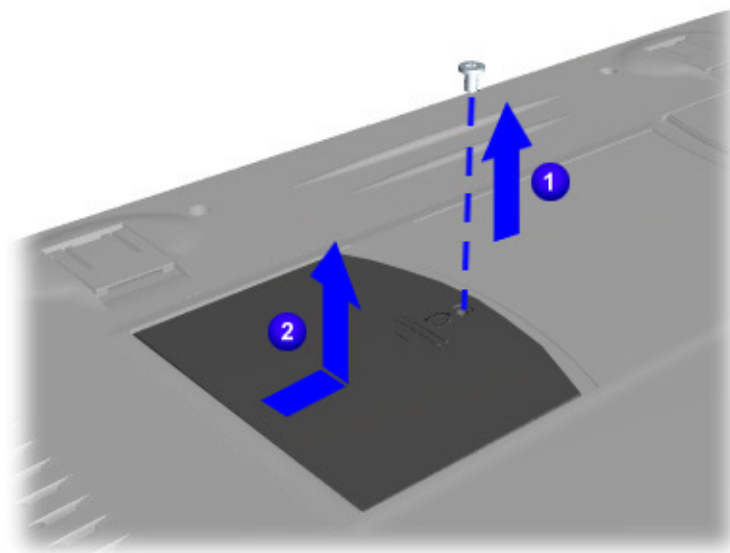

Continued on the next page.

# maintenance & service guide

## Presario 1200XL Series Model XL300, XL300A, and XL300B

4. Press the release latches ① on each side that hold the modem in place. This releases the modem board from the compartment.

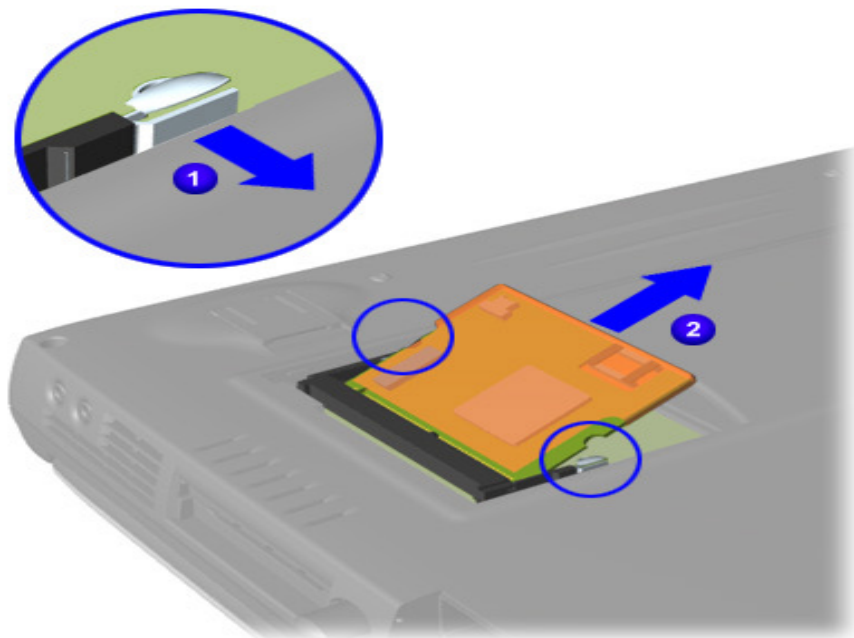

5. Lift ② the modem from the system board connector.

To replace the modem board, reverse these procedures.

# maintenance & service guide

**Presario 1200XL Series**  
**Model XL300, XL300A, and XL300B**

## *Removing the Memory Module*

To remove the memory module, complete the following steps:

1. Prepare the Notebook for disassembly ([pg 9](#)).
2. Close the display and turn the Notebook upside down.
3. Remove the screw from the memory compartment.
4. With the front of the Notebook facing you, slide the door to the left and lift.
5. Pull **1** the side levers to release the memory module and lift **2** it off the connector on the system board.

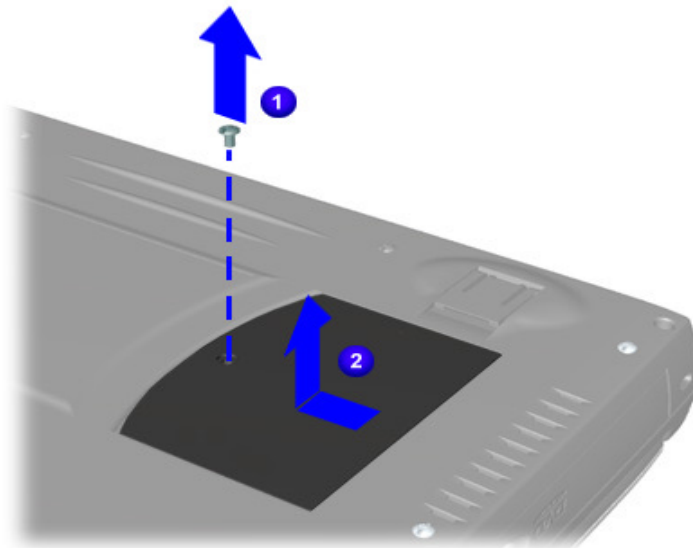

To replace the memory module, reverse these procedures.

# maintenance & service guide

**Presario 1200XL Series**  
**Model XL300, XL300A, and XL300B**

## *Removing the Palmrest Cover with TouchPad*

**Note:** It is not necessary to remove the display panel assembly to access the interior components of the Notebook.

To remove the Palmrest Cover with TouchPad, complete the following steps:

1. Prepare the Notebook for disassembly ([pg 9](#)).
2. Close the display and turn the Notebook upside down.
3. Remove four screws from underneath the Notebook.

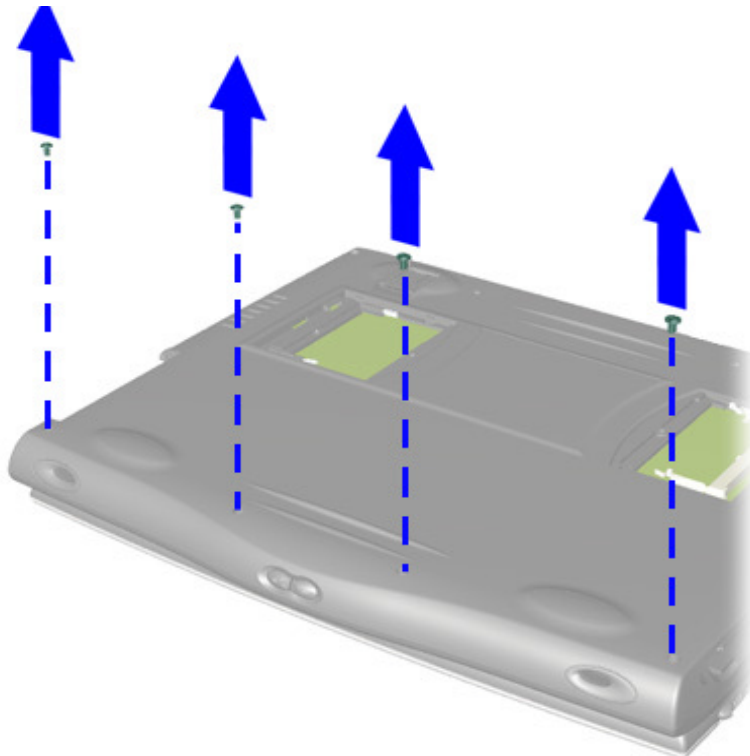

Continued on next page.

# maintenance & service guide

## Presario 1200XL Series Model XL300, XL300A, and XL300B

4. Turn the Notebook right side up.
5. Pull the display release latches and open the display assembly.
6. Lift up ① the front end of the Palmrest Cover, ② disconnect the flex cable from the underside of the Palmrest LED and Volume Control board.
7. Lift the cover off the unit.



To replace the Palmrest Cover with TouchPad, reverse these procedures.



# maintenance & service guide

**Presario 1200XL Series**  
**Model XL300, XL300A, and XL300B**

## *Removing the Keyboard*

To remove the keyboard, complete the following steps:

1. Prepare the Notebook for disassembly ([pg 9](#)).
2. Remove the Palmrest Cover with TouchPad ([pg 14](#)).
3. Gently lift up the front of the keyboard, slide it forward, and then turn the keyboard over allowing it to rest where the Palmrest cover normally sits.
4. Disconnect the flex cable from the [ZIF Connector](#) on the system board and remove the keyboard.

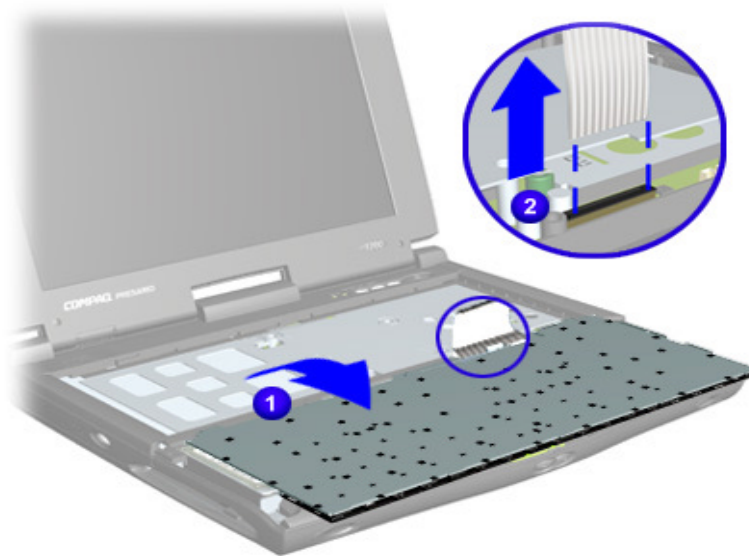

To replace the keyboard, reverse these procedures.

When replacing the keyboard, the [Keyboard Ribbon Cable](#) should fold behind the [ZIF Connector](#) rather than underneath the keyboard.

# maintenance & service guide

**Presario 1200XL Series**  
**Model XL300, XL300A, and XL300B**

## *Removing the Heatspreader*

To remove the Heatspreader, complete the following steps:

1. Prepare the Notebook for disassembly ([pg 9](#)).
2. Remove the Palmrest Cover with TouchPad ([pg 14](#)).
3. Remove the keyboard ([pg 16](#)).
4. Remove four screws ❶ from the Heatspreader and lift it ❷ out of the chassis.

**Note:** Positions of screws are numbered on the Heatspreader.

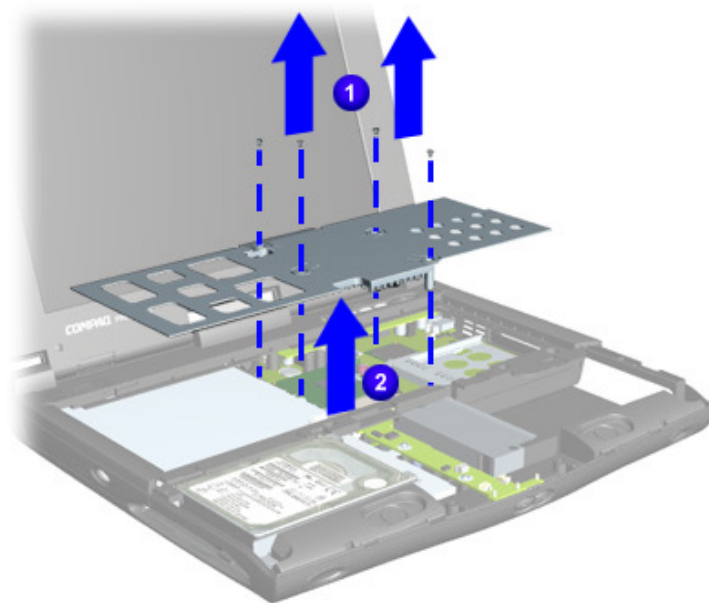

To replace the Heatspreader, reverse the previous procedures.

**Note:** If the thermal pads on the Heatspreader are missing or damaged, a new Heatspreader should be installed.

**Important:** Before installing the new Heatspreader, remove the plastic covering from the thermal pads.



To prevent damage, do not use excessive force when replacing the screws.

# maintenance & service guide

**Presario 1200XL Series**  
**Model XL300, XL300A, and XL300B**

## *Removing the Internet Zone Cover*

*(Status Panel Assembly)*

**Note:** Illustrations may show parts removed that are not part of this procedure. It is necessary to remove only the parts listed in the written procedure.

To remove the Internet Zone cover, complete the following steps:

1. Prepare the Notebook for disassembly ([pg 9](#)).
2. Remove the Palmrest Cover with TouchPad ([pg 14](#)).
3. Remove the keyboard ([pg 16](#)).
4. Open the display, gently pry open the display hinge covers, and slide them off the hinges.

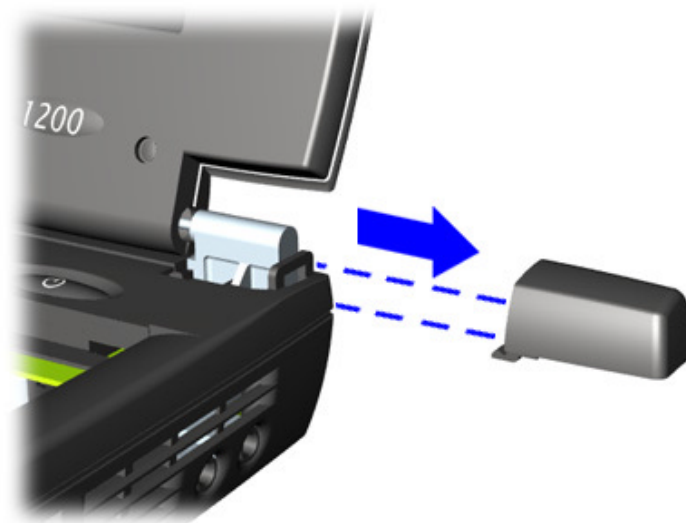

Continued on next page.

# maintenance & service guide

**Presario 1200XL Series**  
**Model XL300, XL300A, and XL300B**

5. Close the Display, turn the unit upside down, and remove two screws located at the back of the Notebook that secure the Internet Zone cover to the chassis .

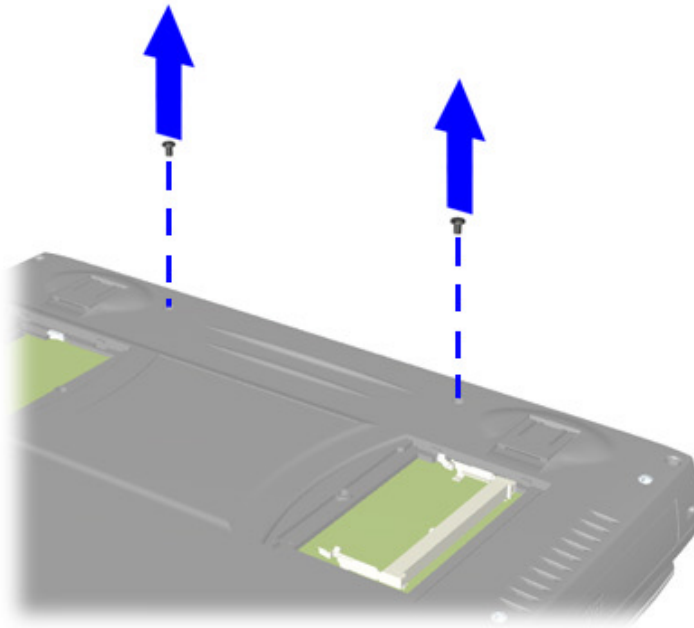

Continued on next page.

# maintenance & service guide

## Presario 1200XL Series Model XL300, XL300A, and XL300B

6. Turn Notebook right side up and open the display panel.
7. Remove the two innermost screws from the display hinges that secure the status panel to the chassis.



Continued on next page.

# maintenance & service guide

## Presario 1200XL Series Model XL300, XL300A, and XL300B

8. Lift up one corner of the Internet Zone cover and push forward from the back (center piece) ❶ to release the snaps on the Internet Zone cover.
9. Remove Internet Zone cover ❷ from the chassis.

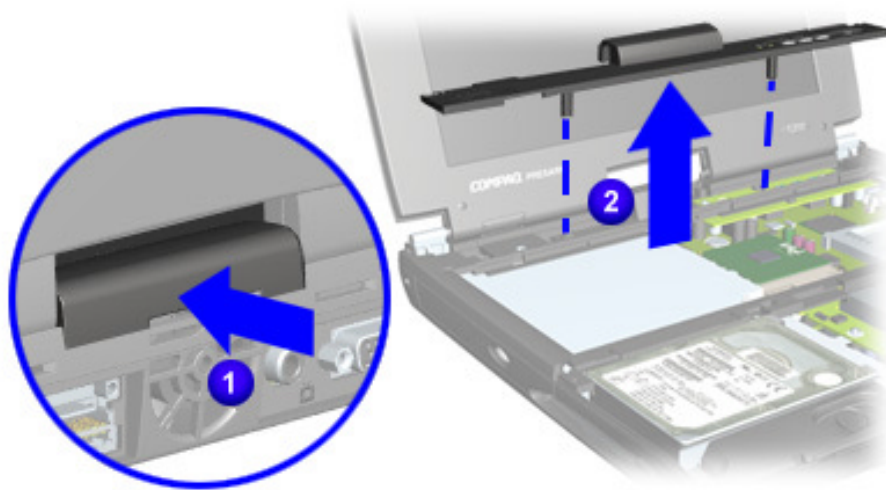

To replace the Internet Zone Cover, reverse these procedures.

# maintenance & service guide

**Presario 1200XL Series**  
**Model XL300, XL300A, and XL300B**

## *Removing the LVDS Board*

*(Available only on models with a TFT display panel)*

**Note:** Illustrations may show parts removed that are not part of this procedure. It is necessary to remove only the parts listed in the written procedure.

To remove the internet button board, complete the following steps:

1. Prepare the Notebook for disassembly ([pg 9](#)).
2. Remove the Internet Zone cover ([pg 18](#)).
3. Disconnect the internet button cable from the right side of the Internet Zone button board.

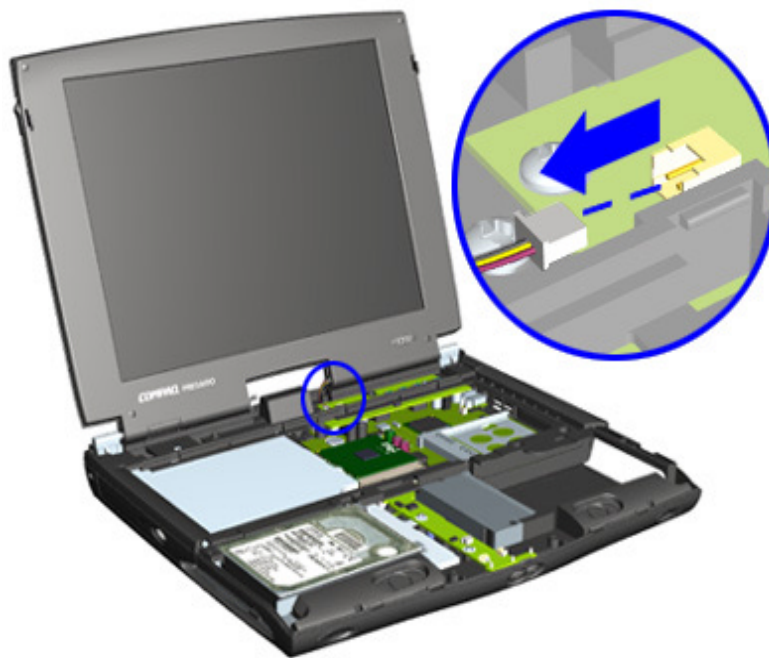

Continued on the next page.

# maintenance & service guide

**Presario 1200XL Series**  
**Model XL300, XL300A, and XL300B**

4. Remove two screws securing the LVDS button board and remove it from the chassis.

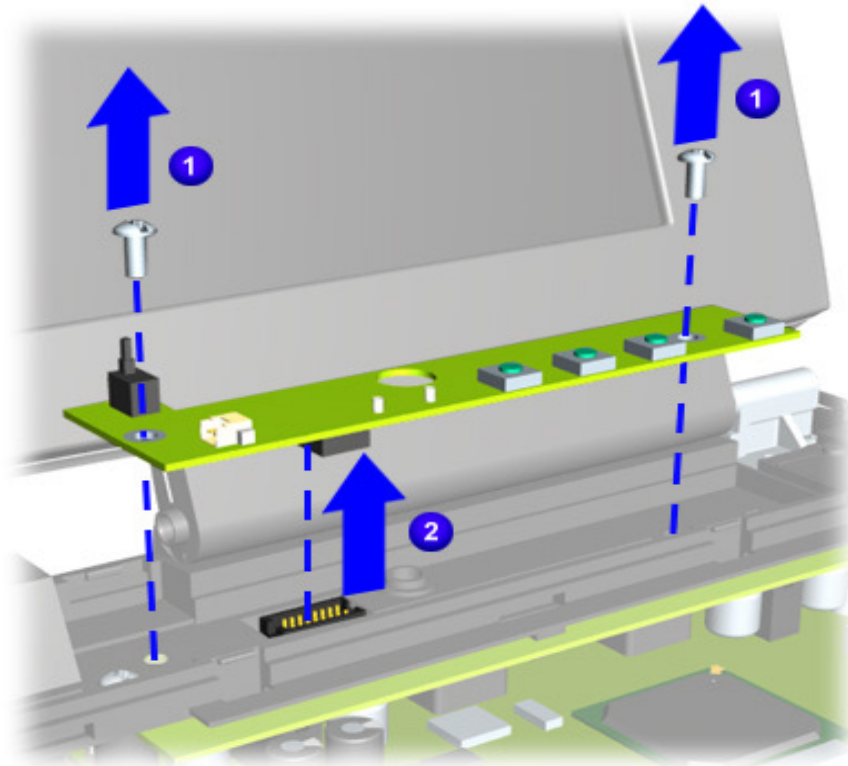

To replace the LVDS button board, reverse these procedures.



# maintenance & service guide

**Presario 1200XL Series**  
**Model XL300, XL300A, and XL300B**

## *Removing the Hard Drive*

**Note:** Illustrations may show parts removed that are not part of this procedure. It is necessary to remove only the parts listed in the written procedure.

To remove the hard drive, complete the following steps:

1. Prepare the Notebook for disassembly ([pg 9](#)).
2. Remove the Palmrest Cover with TouchPad ([pg 14](#)).
3. Remove the Heatspreader ([pg 17](#)).
4. Remove the three screws **①** from the hard drive mounting bracket.
5. Lift the hard drive from the chassis **②** and then disconnect the hard drive cable by gently pulling the cable from the hard drive connector.

**Note:** Disconnect the cable from the hard drive after the hard drive is lifted from the chassis.

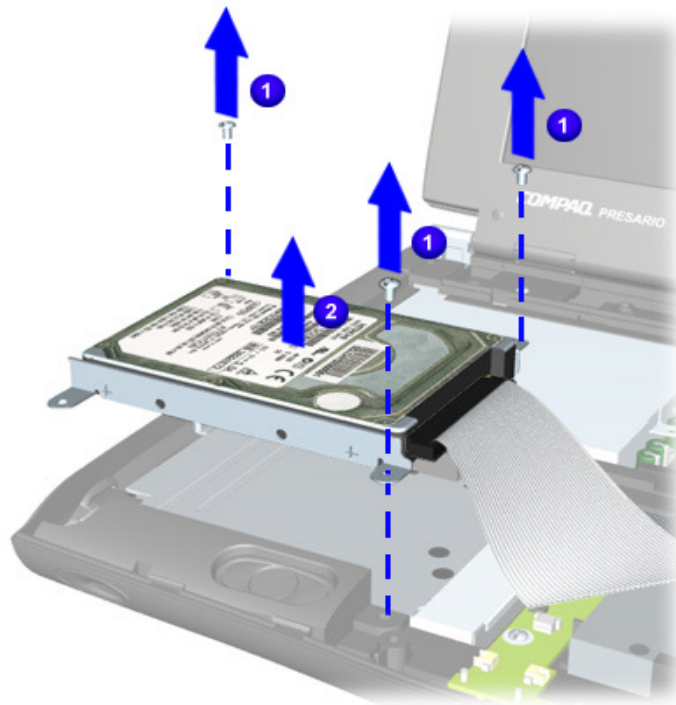

# maintenance & service guide

**Presario 1200XL Series  
Model XL300, XL300A, and XL300B**

## Removing the Hard Drive Mounting Brackets

To remove the hard drive mounting brackets, remove two screws from each side of the hard drive.

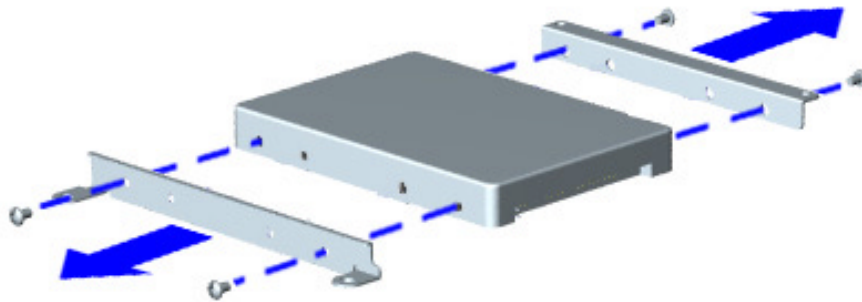

To replace the hard drive and mounting brackets, reverse these procedures.

# maintenance & service guide

**Presario 1200XL Series**  
**Model XL300, XL300A, and XL300B**

## *Removing the Processor*

To remove the processor, complete the following steps:

1. Prepare the Notebook for disassembly ([pg 9](#)).
2. Remove the Palmrest Cover with TouchPad ([pg 14](#)).
3. Remove the keyboard ([pg 16](#)).
4. Remove the Heatspreader ([pg 17](#)).
5. Lift the lever **1** to release the processor, and lift the processor **2** off the system board connector.

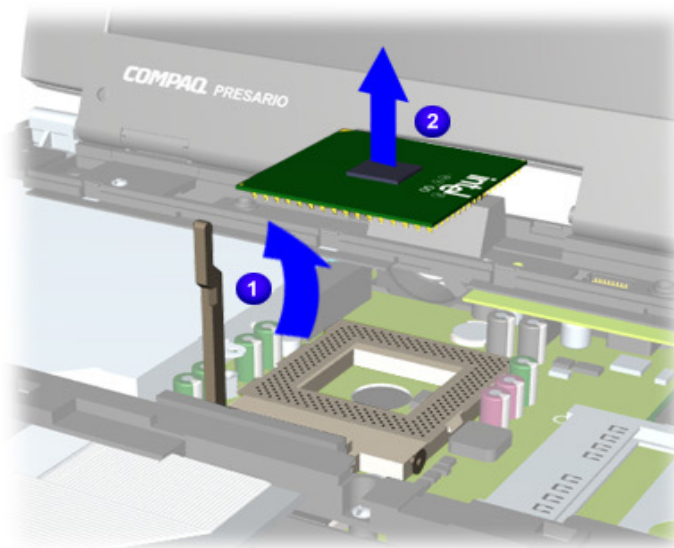

Continued on next page.

# maintenance & service guide

**Presario 1200XL Series**  
**Model XL300, XL300A, and XL300B**

## *Replacing the Processor*

To replace the processor, perform the following steps:

1. Fully align the processor pins with the system board connector.

**Note:** When replacing the processor, verify that its number one pin (the gold triangle) is properly aligned with the number one pin (silver triangle) on the system board connector.

2. Press down carefully on the processor directly over the connectors to seat the processor on the system board.
3. Lower the lever to lock the processor in place.
4. Reassemble the remaining components by reversing their removal procedures.

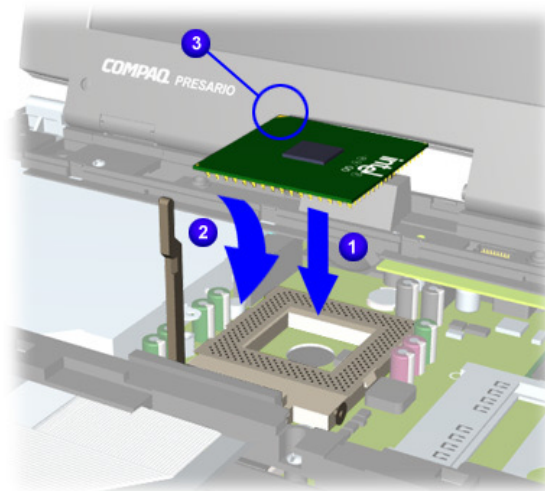

# maintenance & service guide

**Presario 1200XL Series**  
**Model XL300, XL300A, and XL300B**

## *Removing the Display Panel Assembly*

**Note:** Illustrations may show parts removed that are not part of this procedure. It is necessary to remove only the parts listed in the written procedure.

To remove the display panel assembly, complete the following steps:

1. Prepare the Notebook for disassembly ([pg 9](#)).
2. Remove the Internet Zone cover ([pg 18](#)).
3. Remove the button board.
4. Remove the keyboard ([pg 16](#)).
5. Remove the Heatspreader ([pg 17](#)).
6. Remove one screw from the left side of the cable connector cover and lift the cover from the chassis.
7. Disconnect the display flex cable by gently pulling up to release it from the connector.

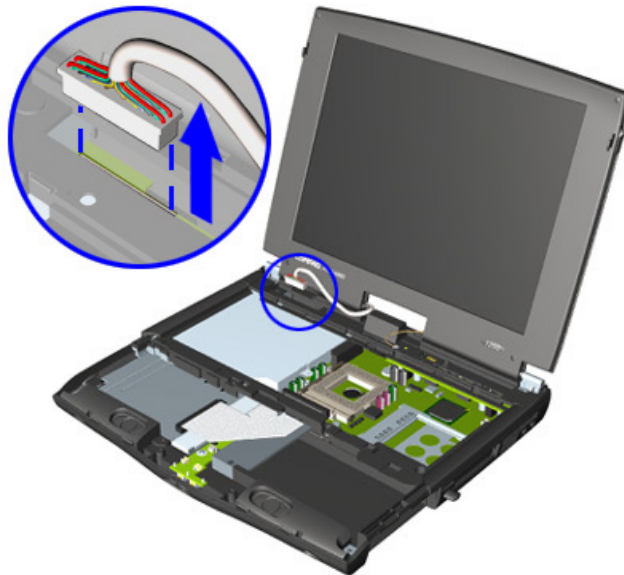

Continued on the next page.

# maintenance & service guide

## Presario 1200XL Series Model XL300, XL300A, and XL300B

8. While supporting the display, remove ❶ the two outermost screws securing the display to the chassis and lift ❷ the display panel out of the hinges.



To replace the display panel, reverse these procedures.

# maintenance & service guide

**Presario 1200XL Series**  
**Model XL300, XL300A, and XL300B**

## *Removing the Upper CPU Cover*

To remove the upper CPU cover, complete the following steps:

1. Prepare the Notebook for disassembly ([pg 9](#)).
2. Remove the Palmrest Cover with TouchPad ([pg 14](#)).
3. Remove the keyboard ([pg 16](#)).
4. Remove the Heatspreader ([pg 17](#)).
5. Remove the Internet Zone cover ([pg 18](#)).
6. Remove the LVDS button board ([pg 22](#)).
7. Remove the hard drive ([pg 24](#)).
8. Remove the display panel assembly ([pg 28](#)).
9. Remove four screws **1** located on the top of the upper CPU cover.

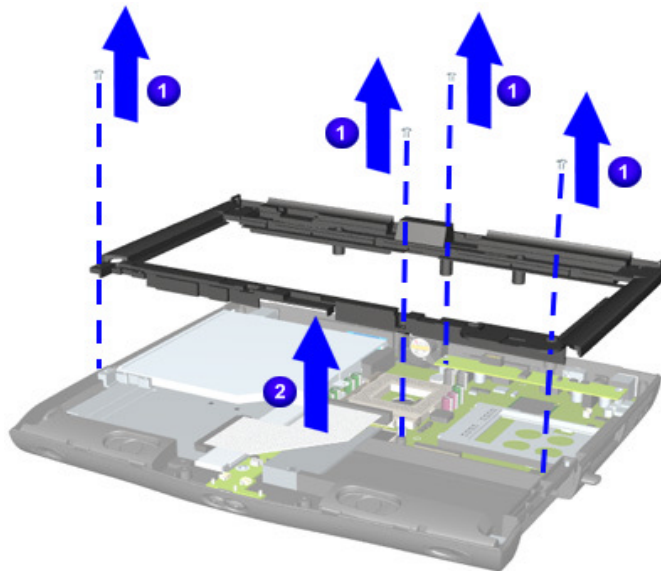

Continued on the next page.

# maintenance & service guide

**Presario 1200XL Series**  
**Model XL300, XL300A, and XL300B**

10. Turn the Notebook upside down and remove one screw.

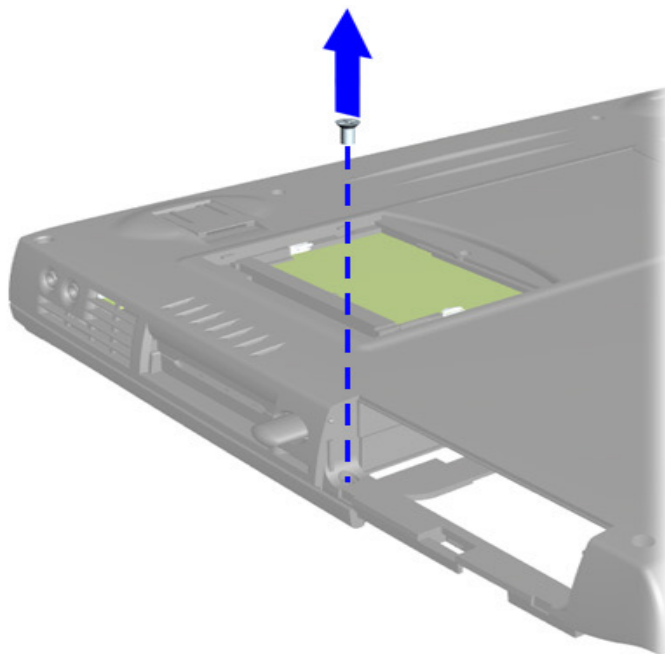

11. Turn the Notebook right side up and lift the cover off the chassis.

**Note:** Now that the upper CPU cover is removed, you can remove the hard drive ribbon cable from the system board



# maintenance & service guide

**Presario 1200XL Series**  
**Model XL300, XL300A, and XL300B**

## *Removing the Hard Drive Cable*

1. Disconnect the hard drive cable by pulling the cable off the connector.

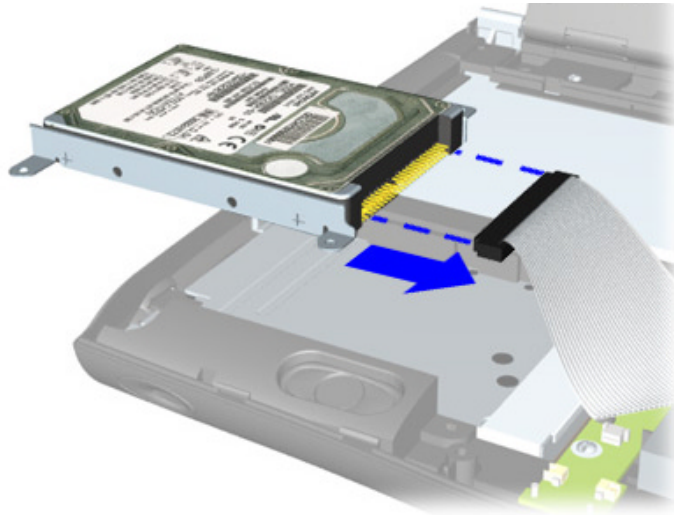

# maintenance & service guide

**Presario 1200XL Series**  
**Model XL300, XL300A, and XL300B**

## *Removing the CD/DVD Drive*

To remove the CD/DVD Drive, complete the following steps:

1. Prepare the Notebook for disassembly ([pg 9](#)).
2. Remove the Palmrest Cover with TouchPad ([pg 14](#)).
3. Remove the keyboard ([pg 16](#)).
4. Remove the Heatspreader ([pg 17](#)).
5. Remove the display panel assembly ([pg 28](#)).
6. Remove the upper CPU cover ([pg 30](#)).
7. Turn the Notebook upside down and remove the two screws securing the CD/DVD drive to the chassis.

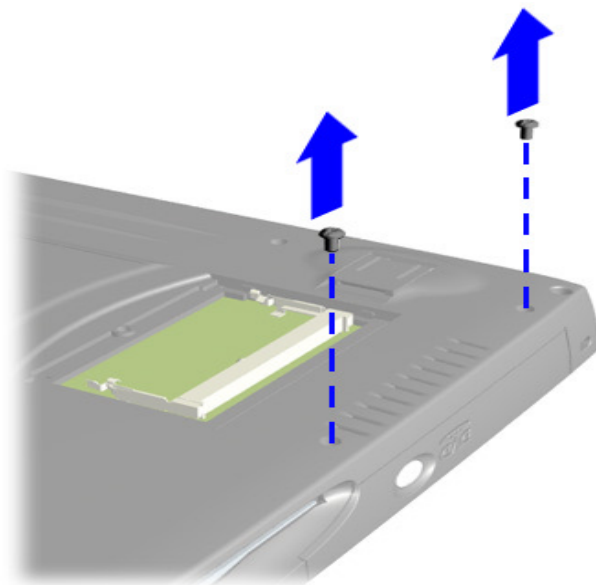

# maintenance & service guide

## Presario 1200XL Series Model XL300, XL300A, and XL300B

8. Push the CD/DVD drive forward from the back of the drive to disconnect it from the system board, and lift the CD/DVD to remove it.

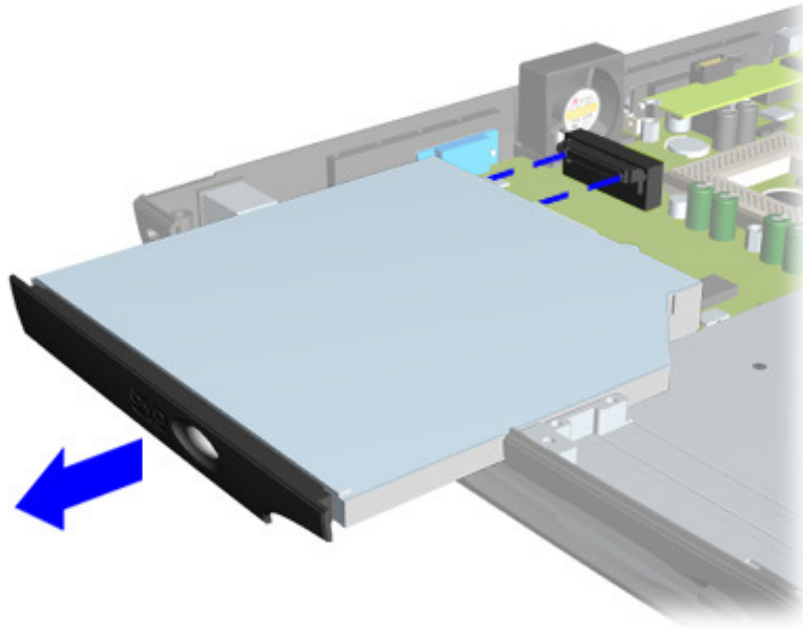

To replace the CD/DVD drive, reverse these procedures.

# maintenance & service guide

**Presario 1200XL Series**  
**Model XL300, XL300A, and XL300B**

## *Removing the Power Supply Board*

To remove the power supply board, complete following steps:

1. Prepare the Notebook for disassembly ([pg 9](#)).
2. Remove the Palmrest Cover with TouchPad ([pg 14](#)).
3. Remove the keyboard ([pg 16](#)).
4. Remove the Heatspreader ([pg 17](#)).
5. Remove the Internet Zone cover ([pg 18](#)).
6. Remove the LVDS button board ([pg 22](#)).
7. Remove the hard drive ([pg 24](#)).
8. Remove the display panel assembly ([pg 28](#)).
9. Remove the upper CPU cover ([pg 30](#)).
10. Remove one screw **1** from the right side of the board, and gently rock back and forth to disconnect it **2** from the system board

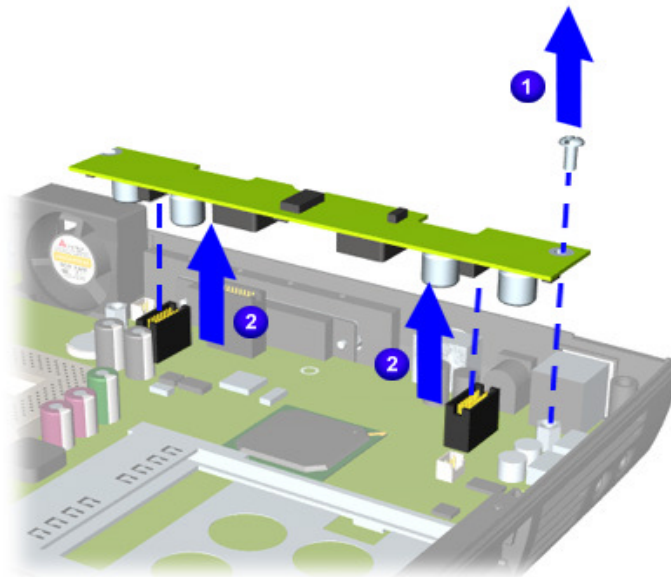

# maintenance & service guide

**Presario 1200XL Series**  
**Model XL300, XL300A, and XL300B**

## *Removing the Fan Assembly*

To remove the fan assembly, complete the following steps:

1. Prepare the Notebook for disassembly ([pg 9](#)).
2. Remove the Palmrest Cover with TouchPad ([pg 14](#)).
3. Remove the keyboard ([pg 16](#)).
4. Remove the Heatspreader ([pg 17](#)).
5. Remove the Internet Zone cover ([pg 18](#)).
6. Remove the LVDS button board ([pg 22](#)).
7. Remove the hard drive ([pg 24](#)).
8. Remove the display panel assembly ([pg 28](#)).
9. Remove the upper CPU cover ([pg 30](#)).
10. Remove the power supply board ([pg 35](#)).
11. Disconnect ❶ the fan cable from the connector on the system board and lift ❷ the fan assembly from the chassis slot.

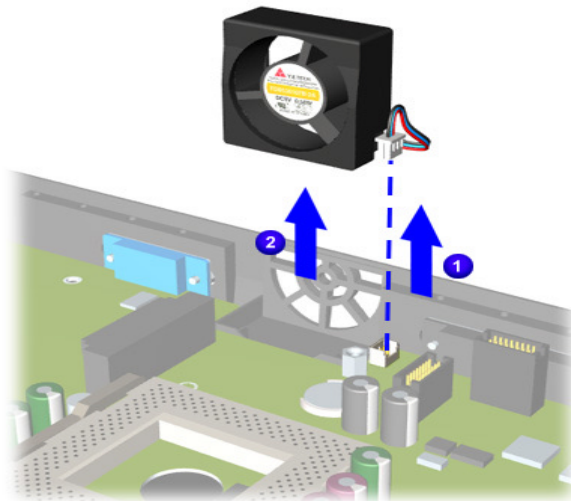

Continued on the next page.

# maintenance & service guide

**Presario 1200XL Series**  
**Model XL300, XL300A, and XL300B**

To remove the fan gasket, pull the gasket from the fan.

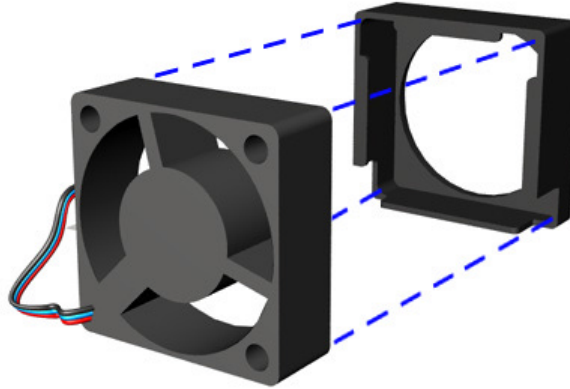

To replace the fan assembly and gasket, reverse these procedures.

**Important:** When replacing the fan assembly ensure the manufacturing label is pointing inward.

# maintenance & service guide

**Presario 1200XL Series**  
**Model XL300, XL300A, and XL300B**

## *Removing the Real Time Clock Battery*

 **CAUTION:** Removing the RTC battery clears the Power-on password and removes all setup attributes that are programmed in the CMOS.

To remove the RTC battery, complete the following steps:

1. Prepare the Notebook for disassembly ([pg 9](#)).
2. Remove the Palmrest Cover with TouchPad ([pg 14](#)).
3. Remove the Keyboard ([pg 16](#)).
4. Remove the Heatspreader ([pg 17](#)).
5. Remove the Upper CPU Cover ([pg 30](#)).
6. Remove the Power Supply Board ([pg 35](#)).
7. Locate the RTC battery next to the CD/DVD connector.
8. Using a non-metallic object, gently pry the RTC battery upward to remove it.

To replace the RTC battery, press it firmly into the socket and reassemble the remaining components by reversing their removal procedures.

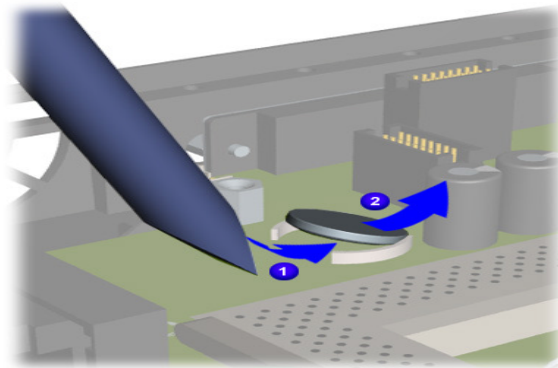

 **CAUTION:** When removing the RTC battery from the system board, it is extremely important to use a non-metallic object to pry up the RTC battery to prevent damage to the system board or the battery.

# maintenance & service guide

**Presario 1200XL Series**  
**Model XL300, XL300A, and XL300B**

## *Removing the Battery Charger and Audio Board* *(Voltage Converter Board)*

To remove the battery charger board, complete the following steps:

1. Prepare the Notebook for disassembly ([pg 9](#)).
2. Remove the Palmrest Cover with TouchPad ([pg 14](#)).
3. Remove the keyboard ([pg 16](#)).
4. Remove the Heatspreader ([pg 17](#)).
5. Remove the Internet Zone cover ([pg 18](#)).
6. Remove the LVDS button board ([pg 22](#)).
7. Remove the hard drive ([pg 24](#)).
8. Remove the display panel assembly ([pg 28](#)).
9. Remove the upper CPU cover ([pg 30](#)).
10. Remove the diskette drive and the ribbon cable ([pg 42](#)).
11. Remove the hard drive cable located above the battery charger board ([pg 32](#)).
12. Remove the floppy cable located above the battery charger board ([pg 42](#)).

Continued on next page.



# maintenance & service guide

**Presario 1200XL Series  
Model XL300, XL300A, and XL300B**

13. Disconnect the speaker cable.

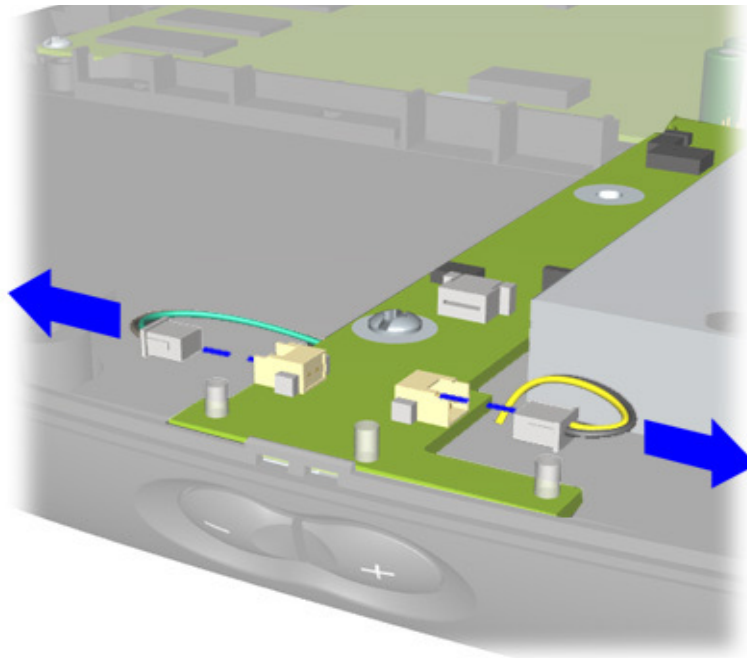

Continued on next page.

# maintenance & service guide

## Presario 1200XL Series Model XL300, XL300A, and XL300B

14. Remove ❶ one screw from the battery charger and audio board and disconnect ❷ the board from the connector on the system board.
15. Lift the battery charger and audio board out of the chassis.

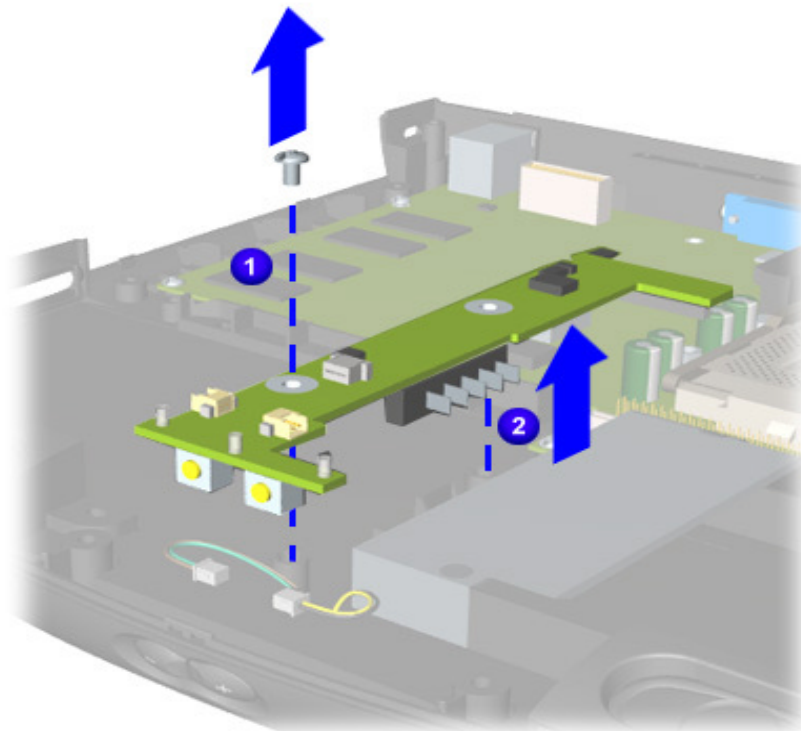

To replace the battery charger board, reverse these procedures.

**Important:** When replacing the battery charger board, ensure that the pins are aligned with the connector on the system board.

# maintenance & service guide

**Presario 1200XL Series**  
**Model XL300, XL300A, and XL300B**

## *Removing the Diskette Drive*

To remove the diskette drive, complete the following steps:

1. Prepare the Notebook for disassembly ([pg 9](#)).
2. Remove the Palmrest Cover with TouchPad ([pg 14](#)).
3. Remove the keyboard ([pg 16](#)).
4. Remove the Heatspreader ([pg 17](#)).
5. Remove the CD or DVD drive ([pg 33](#)).
6. Remove the Internet Zone cover ([pg 18](#)).
7. Remove the LVDS button board ([pg 22](#)).
8. Remove the display panel assembly ([pg 28](#)).
9. Remove the hard drive ([pg 24](#)).
10. Remove the upper CPU cover ([pg 30](#)).

Continued on next page.

# maintenance & service guide

**Presario 1200XL Series  
Model XL300, XL300A, and XL300B**

11. Remove screw from the diskette drive retaining bracket and lift the bracket out of the chassis.

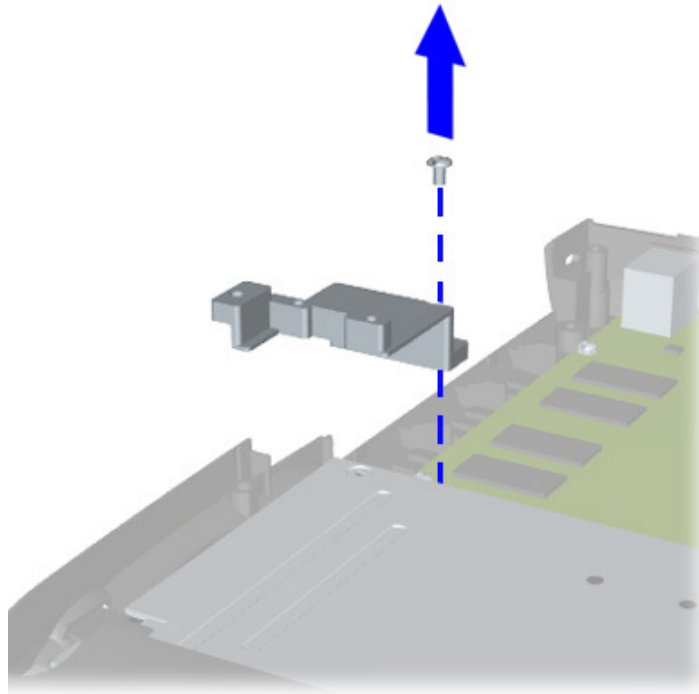

Continued on next page.

# maintenance & service guide

**Presario 1200XL Series  
Model XL300, XL300A, and XL300B**

12. Disconnect the diskette drive ribbon from the system board to expose the screw.

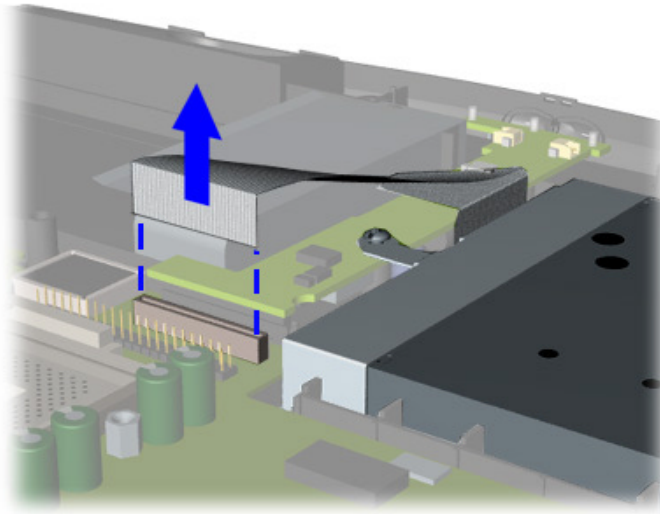

Continued on next page.

# maintenance & service guide

**Presario 1200XL Series**  
**Model XL300, XL300A, and XL300B**

13. Remove two screws ❶ and lift the diskette drive ❷ from the chassis.

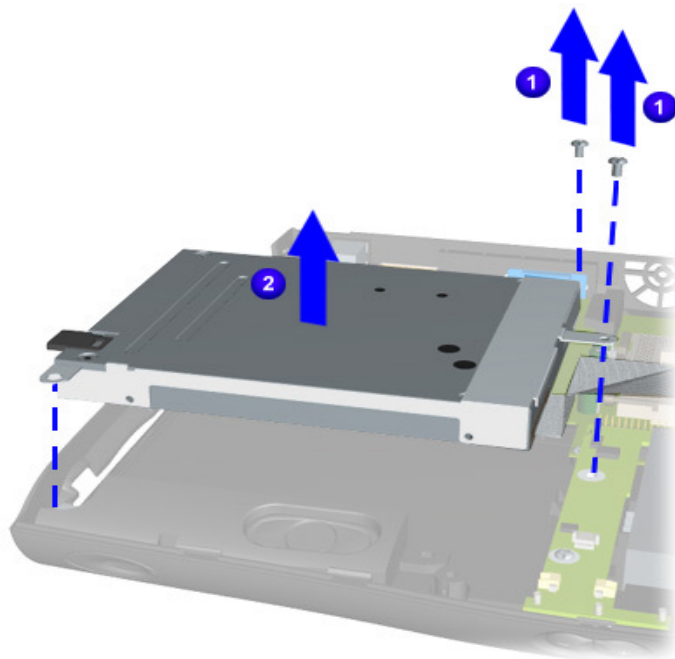

To replace the diskette drive, reverse these procedures.

 **CAUTION:** Ensure that cables are placed in their proper locations during the reassembly process.

# maintenance & service guide

**Presario 1200XL Series**  
**Model XL300, XL300A, and XL300B**

## *Removing the Speaker Assembly*

To remove the speaker assembly, complete the following steps:

1. Prepare the Notebook for disassembly ([pg 9](#)).
2. Remove the Palmrest Cover with TouchPad ([pg 14](#)).
3. Remove the keyboard ([pg 16](#)).
4. Remove the display panel assembly ([pg 28](#)).
5. Remove the Internet Zone cover ([pg 18](#)).
6. Remove the LVDS button board ([pg 22](#)).
7. Remove the Heatspreader ([pg 17](#)).
8. Remove the upper CPU cover ([pg 30](#)).
9. Remove the hard drive ([pg 24](#)).
10. Remove the battery charger and audio board ([pg 39](#)).

Continued on next page.

# maintenance & service guide

## Presario 1200XL Series Model XL300, XL300A, and XL300B

11. Lift the speaker assembly from the chassis.

**Note:** Before disconnecting the speaker cables from the system board, verify the color coded positioning of the left and right speaker cables to ensure that the speaker assembly cable is placed in its proper location during the reassembly process.

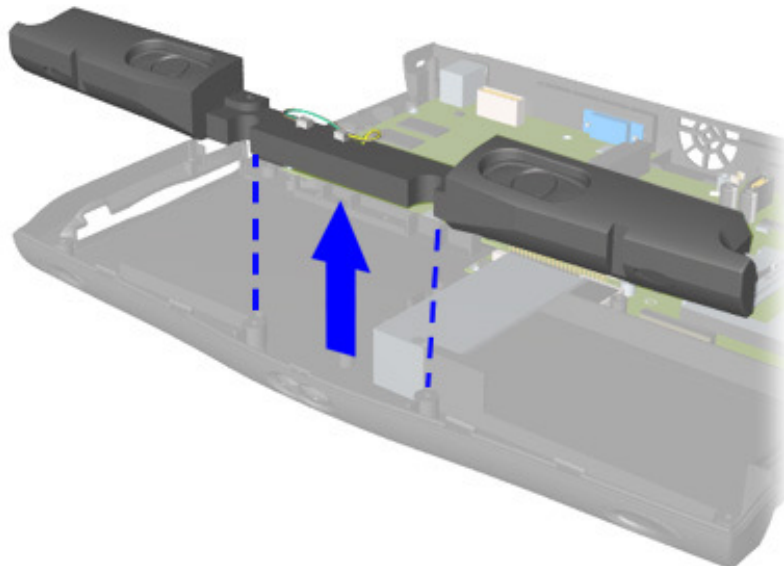

To replace the speaker assembly, reverse these procedures.



# maintenance & service guide

**Presario 1200XL Series**  
**Model XL300, XL300A, and XL300B**

## *Removing the System Board*

To remove the system board, complete the following steps:

1. Prepare the Notebook for disassembly ([pg 9](#)).
2. Remove the Palmrest Cover with TouchPad ([pg 14](#)).
3. Remove the keyboard ([pg 16](#)).
4. Remove the display panel assembly ([pg 28](#)).
5. Remove the Internet Zone cover ([pg 18](#)).
6. Remove the LVDS button board ([pg 22](#)).
7. Remove the Heatspreader ([pg 17](#)).
8. Remove the processor ([pg 26](#)).
9. Remove the CD or DVD drive ([pg 33](#)).
10. Remove the upper CPU cover ([pg 30](#)).
11. Remove the hard drive ([pg 24](#)).
12. Remove the fan assembly ([pg 36](#)).
13. Remove the battery charger and audio board ([pg 39](#)).
14. Disconnect the diskette drive cable from the system board ([pg 42](#)).
15. Disconnect the speaker assembly cables from the system board ([pg 46](#)).

Continued on next page.

# maintenance & service guide

**Presario 1200XL Series**  
**Model XL300, XL300A, and XL300B**

16. Remove the three standoffs and three screws from the system board.

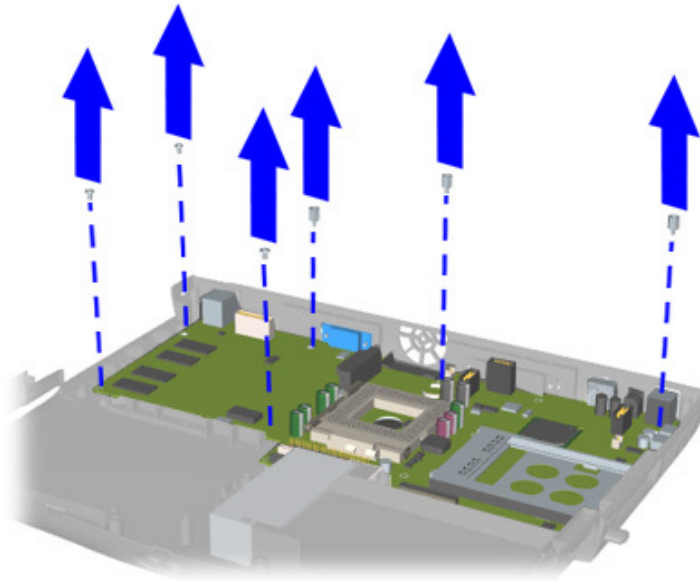

Continued on next page.

# maintenance & service guide

**Presario 1200XL Series**  
**Model XL300, XL300A, and XL300B**

17. Remove four screws from the rear connector.

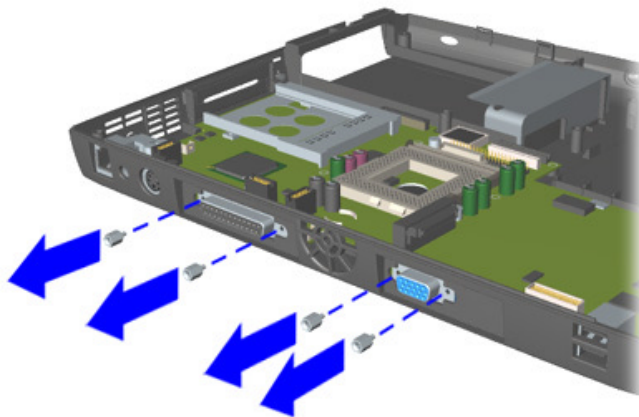

**Note:** Ensure that the PCMCIA eject button and microphone insertion is not sticking out through the slot in the chassis.

18. Lift the system board up gently, prying the right side of the chassis to remove it.

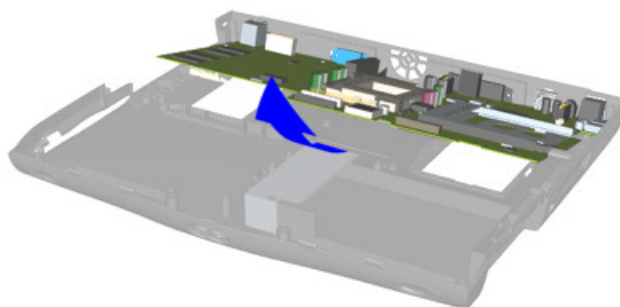

To replace the system board, reverse these procedures.

**Important:** Before replacing the system board, remove all remaining cables.