

Thank you for purchasing this Factory Service Manual CD/DVD from servicemanuals4u.com.

Please check out our eBay auctions for more great deals on Factory Service Manuals:

[servicemanuals4u](http://servicemanuals4u.com)

COMPAQ

[STORE](#) | [PRODUCTS](#) | [SERVICES](#) | [SUPPORT](#) | [CONTACT US](#) | [SEARCH](#)

Maintenance & Service Guide

Presario 1600 Series

Models: 1650 and 1655

[Home Page](#) | [Notice](#) | [Preface](#) | [Product Description](#) | [Troubleshooting](#)
[Illustrated Parts Catalog](#) | [Removal & Replacement Procedures](#) | [Specifications](#)
[Pin Assignments](#) | [Battery Pack Operations](#)

| |
|--|
| Notice |
| Preface |
| Product Description |
| Troubleshooting |
| Illustrated Parts Catalog |
| Removal & Replacement Procedures |
| Specifications |
| Connector Pin Assignments |
| Battery Pack Operations |



[Click here to download the zip file for the following Maintenance & Service Guide.](#)

Welcome to the Maintenance & Service Guide (MSG). This online guide is designed to serve the needs of those whose job it is to repair Compaq products. Many of the components of the hardcopy MSG are contained in this online guide. The Notice, contains the copyright and trademark information. The Preface shows symbol conventions, Technician Notes and Serial Number locations on the unit. This MSG will be periodically maintained and updated online as needed. For content comments or questions, contact the [Editor](#).

To report a technical problem, contact your Regional Support Center or IM Help Center.

1.800.AT.COMPAQ

[privacy and legal statement](#)

COMPAQ

[STORE](#) | [PRODUCTS](#) | [SERVICES](#) | [SUPPORT](#) | [CONTACT US](#) | [SEARCH](#)

Maintenance & Service Guide

Presario 1600 Series

Models: 1650 and 1655

[Home Page](#) | [Notice](#) | [Preface](#) | [Product Description](#) | [Troubleshooting](#)
[Illustrated Parts Catalog](#) | [Removal & Replacement Procedures](#) | [Specifications](#)
[Pin Assignments](#) | [Battery Pack Operations](#)

Notice

The information in this guide is subject to change without notice.

COMPAQ COMPUTER CORPORATION SHALL NOT BE LIABLE FOR TECHNICAL OR EDITORIAL ERRORS OR OMISSIONS CONTAINED HEREIN, NOR FOR INCIDENTAL OR CONSEQUENTIAL DAMAGES RESULTING FROM THE FURNISHING, PERFORMANCE, OR USE OF THIS MATERIAL.

This guide contains information protected by copyright. No part of this guide may be photocopied or reproduced in any form without prior written consent from Compaq Computer Corporation.

© 1998 Compaq Computer Corporation.
All rights reserved. Printed in the U.S.A.

Compaq, Presario Registered U. S. Patent and Trademark Office.

Microsoft, MS-DOS, and Windows are registered trademarks of Microsoft Corporation.
Windows 95 is a trademark of Microsoft Corporation.

The software described in this guide is furnished under a license agreement or nondisclosure agreement. The software may be used or copied only in accordance with the terms of the agreement.

Product names mentioned herein may be trademarks and/or registered trademarks of their respective companies.

Maintenance and Service Guide

Compaq Presario 1600 Series Portable Computers

First Edition (June 1998)
Compaq Computer Corporation

1.800.AT.COMPAQ

[privacy and legal statement](#)

COMPAQ

[STORE](#) | [PRODUCTS](#) | [SERVICES](#) | [SUPPORT](#) | [CONTACT US](#) |
[SEARCH](#)

Maintenance & Service Guide

Presario 1600 Series

Models: 1650 and 1655

| [Home Page](#) | [Notice](#) | [Preface](#) | [Product Description](#) | [Troubleshooting](#)
[Illustrated Parts Catalog](#) | [Removal & Replacement Procedures](#) | [Specifications](#)
[Pin Assignments](#) | [Battery Pack Operations](#)

Preface

This *Maintenance and Service Guide* is a troubleshooting guide that can be used for reference when servicing the Compaq Presario 1600 Series Portable Computers.

Compaq Computer Corporation reserves the right to make changes to the Compaq Presario 1600 Series Portable Computers without notice.

Symbols

The following words and symbols mark special messages throughout this guide.



WARNING: Text set off in this manner indicates that failure to follow directions in the warning could result in bodily harm or loss of life.



CAUTION: Text set off in this manner indicates that failure to follow directions could result in damage to equipment or loss of data.

IMPORTANT: Text set off in this manner presents clarifying information or specific instructions.

NOTE: Text set off in this manner presents commentary, sidelights, or interesting points of information.

Technician Notes



WARNING: Only authorized technicians trained by Compaq should repair this equipment. All troubleshooting and repair procedures are detailed to allow only subassembly/module level repair. Because of the complexity of the individual boards and subassemblies, the user should not attempt to make repairs at the component level or to make modifications to any printed circuit board. Improper repairs can create a safety hazard. Any indications of component replacement or printed circuit board modifications may void any warranty

Serial Number

When requesting information or ordering spare parts, the computer serial number should be provided to Compaq. The serial number is located on the bottom of the computer.

Locating Additional Information

The following documentation is available to support this product:

- Compaq Presario 1600 Series Portable Computer documentation set
- *Introducing Windows 98 Guide*
- Service Training Guides
- Compaq Service Advisories and Bulletins
- *Compaq QuickFind*
- *Compaq Service Quick Reference Guide*

1.800.AT.COMPAQ

[privacy and legal statement](#)

COMPAQ

[STORE](#) | [PRODUCTS](#) | [SERVICES](#) | [SUPPORT](#) | [CONTACT US](#) | [SEARCH](#)

Maintenance & Service Guide

**Presario 1600 Series
Models: 1650 and 1655**

[Home Page](#) | [Notice](#) | [Preface](#) | [Product Description](#) | [Troubleshooting](#)
[Illustrated Parts Catalog](#) | [Removal & Replacement Procedures](#) | [Specifications](#)
[Pin Assignments](#) | [Battery Pack Operations](#)

Product Description

[Models and Features](#)

[Controls and Lights](#)

[Left Side Components](#)

[Right Side Components](#)

[Bottom of Unit](#)

[Rear Connectors](#)

[Port Replicator](#)

[Power Management for Windows 98](#)

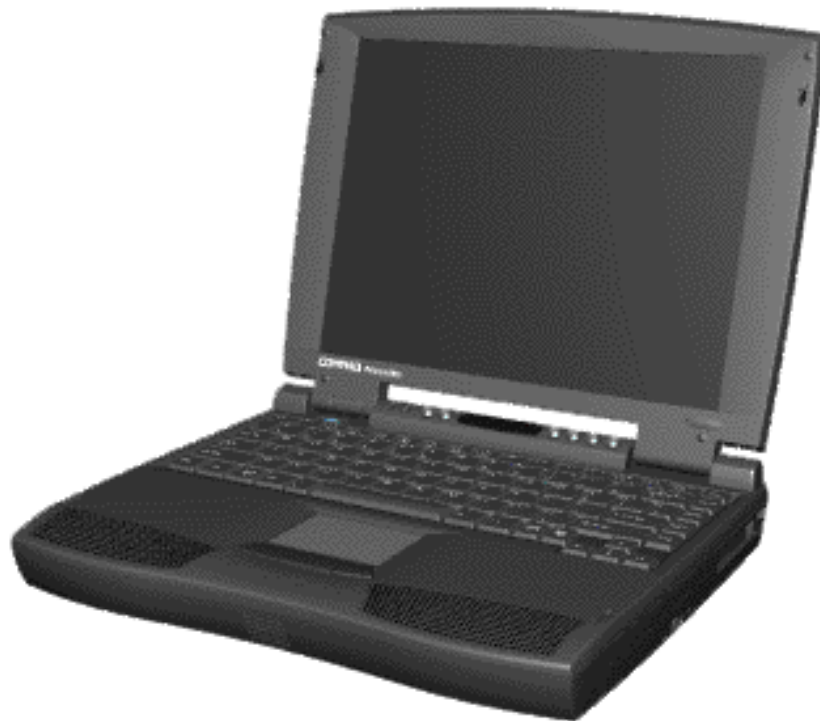

Compaq Presario 1600 Series Portable Computer is a continuation of the new generation of multimedia portable computers with an innovative integrated design, outstanding audio and video, advanced core features, and attractive styling. This full-function, Pentium II -

based series of portable computers allows full desktop functionality and additional connectivity via the optional port replicator.

1.800.AT.COMPAQ

[privacy and legal statement](#)

Maintenance & Service Guide

Presario 1600 Series

Models: 1650 and 1655

[Home Page](#) | [Notice](#) | [Preface](#) | [Product Description](#) | [Troubleshooting](#)
[Illustrated Parts Catalog](#) | [Removal & Replacement Procedures](#) | [Specifications](#)
[Pin Assignments](#) | [Battery Pack Operations](#)

Troubleshooting

[Preliminary Steps](#)

[Clearing the Power-On Password](#)

[Power-On Self Test \(POST\)](#)

[Compaq Diagnostics](#)

[Diagnostic Error Codes](#)

[Troubleshooting Without Diagnostics](#)

[Solving Minor Problems](#)

[Contacting Compaq Support](#)

This section covers troubleshooting information for the Compaq Presario 1600 Series Portable Computers. The basic steps in troubleshooting include:

1. Follow the [Preliminary Steps](#).
2. Run the [Power-On Self-Test \(POST\)](#).
3. Follow the recommended actions described in the diagnostic tables, if you are unable to run POST or if POST displays an error message.

When following the recommended actions in the Sections on POST and [Diagnostic Error Codes](#) perform them in the order listed. Rerun POST after each recommended action until the problem is solved and no error message occurs. Once the problem is solved, do not complete the remaining recommended actions.

NOTE:

If the problem is intermittent, check the computer several times to verify that the problem is solved.

1.800.AT.COMPAQ

[privacy and legal statement](#)

COMPAQ

[STORE](#) | [PRODUCTS](#) | [SERVICES](#) | [SUPPORT](#) | [CONTACT US](#) |
[SEARCH](#)

Maintenance & Service Guide

Presario 1600 Series

Models: 1650 and 1655

[Home Page](#) | [Notice](#) | [Preface](#) | [Product Description](#) | [Troubleshooting](#)
[Illustrated Parts Catalog](#) | [Removal & Replacement Procedures](#) | [Specifications](#)
[Pin Assignments](#) | [Battery Pack Operations](#)

Illustrated Parts Catalog

[System Unit](#)[Boards](#)[Display
Assembly](#)[Mass Storage
Devices](#)[Miscellaneous
Cable Kit](#)[Cables](#)[Miscellaneous
Hardware and
Plastics Kit](#)[Miscellaneous
Parts](#)[Documentation
and Software](#)

This section provides an breakdown and identifies the spare parts ordering number associated with each item(s) for the Compaq Presario 1600 Series Portable Computers.

1.800.AT.COMPAQ

[privacy and legal statement](#)

[COMPAQ](#)[STORE](#) | [PRODUCTS](#) | [SERVICES](#) | [SUPPORT](#) | [CONTACT US](#) | [SEARCH](#)

Maintenance & Service Guide

Presario 1600 Series

Models: 1650 and 1655

| [Home Page](#) | [Notice](#) | [Preface](#) | [Product Description](#) | [Troubleshooting](#)
[Illustrated Parts Catalog](#) | [Removal & Replacement Procedures](#) | [Specifications](#)
[Pin Assignments](#) | [Battery Pack Operations](#)

Removal and Replacement Procedures

This section explains the removal and replacement procedures for the computer.

Serial Number Location

[Disassembly Sequence](#)

[Electrostatic Discharge](#)

[Service Considerations](#)

[Cables and Connectors](#)

[Preparing the Computer for Disassembly](#)

[Battery Pack](#)

[Palmrest Cover with Touch Pad](#)

[Keyboard](#)



Report the computer **1** serial number to Compaq when requesting information or ordering spare parts.

[Heatspreader](#)

[Modem](#)

[Processor](#)

[Status Panel](#)

[Interface
Board](#)

[Hard Drives](#)

[Battery
Charger Board](#)

[CD Drive](#)

[Display Panel
Assembly](#)

[Upper CPU
Cover](#)

[Speaker
Assembly](#)

[Diskette Drive](#)

[Fan Assembly](#)

[Audio Board](#)

[System Board](#)

[Memory
Module](#)

[1.800.AT.COMPAQ](#)

[privacy and legal statement](#)

Maintenance & Service Guide

Presario 1600 Series

Models: 1650 and 1655

| [Home Page](#) | [Notice](#) | [Preface](#) | [Product Description](#) | [Troubleshooting](#)
[Illustrated Parts Catalog](#) | [Removal & Replacement Procedures](#) | [Specifications](#)
[Pin Assignments](#) | [Battery Pack Operations](#)

Specifications

This chapter covers the following specifications of Compaq Presario 1600 Series Portable Computers:

- [Computer models](#)
- [Physical and environmental](#)
- [System Interrupts](#)
- [System DMA](#)
- [System I/O Address](#)
- [System Memory Catalog](#)
- [Display](#)
- [Memory expansion](#)
- [Diskette drive](#)
- [Hard drive](#)
- [CD drive](#)
- [Battery pack](#)

Physical and Environmental

| Computer Specifications | | |
|-------------------------|------|--------|
| | U.S. | Metric |
| | | |

| | | |
|--|---|---------------|
| Dimensions | | |
| Height | 1.97 in | 4.95 cm |
| Depth | 12.20 in | 31.00 cm |
| Width | 10.08 in | 25.40 cm |
| Weight | | |
| Model 1650 | 7.326 lb | 3.33 kg |
| Model 1655 | 7.326 lb | 3.33 kg |
| Stand-Alone (Battery Pack) Power Requirements | NiMH | Li-ion |
| Nominal Operating | W @ 9.6 V | W @ 14.4 V |
| Maximum Average | W @ 9.6 V | W @ 14.4 V |
| Peak Operating | W @ 9.6 V | W @ 14.4 V |
| AC Power Requirements | | |
| Operating Voltage | 100-240 V | |
| Operating Current | 0.8/0.4 A RMS | |
| Operating Frequency | 47-63 Hz | |
| Maximum Transient | Meets IEC 801-4 and IEC801-5 1kV for 50 ns | |
| Temperature | | |
| Operating | 50° to 95 °F | 10° to 35 °C |
| Nonoperating | -4° to 140 °F | -20° to 60 °C |
| Relative Humidity (noncondensing) | | |
| Operating | 10 to 90% | 35°C to 90% |
| Nonoperating (tw = 38.7°C max) | 5 to 95% | 60°C to 95% |
| Altitude | | |
| Operating | 0 to 10,000 ft | 0 to 3.15 km |
| Nonoperating | 0 to 30,000 ft | 0 to 9.14 km |
| Shock | | |
| Operating | 10 G, 11 ms, half sine | |
| Non operating | 240 G, 2 ms, half sine | |
| Vibration | | |
| Operating | 0.5 G | |
| Nonoperating | 1.5 G | |
| NOTE: Applicable product safety standards specify thermal limits for plastic surfaces. Compaq Presario 1600 Series Portable Computers operate well within this range of temperatures. | | |

System Interrupts

| System Interrupts | |
|-------------------|------------------------------|
| Hardware IRQ | System Function |
| IRQ0 | Timer Interrupt |
| IRQ1 | Keyboard |
| IRQ2 | Interrupt Controller Cascade |
| IRQ3 | Internal Modem |

| | |
|-------|--|
| IRQ4 | Communication Port (COM1) |
| IRQ5 | Audio Controller |
| IRQ6 | Diskette Drive |
| IRQ7 | Parallel Port (LPT 1) (default) |
| IRQ8 | System CMOS/Real-Time Clock |
| IRQ9 | IRQ Holder for PCI Steering |
| IRQ9 | PCI-1131 CardBus Controller |
| IRQ9 | IRQ Holder for PCI Steering |
| IRQ9 | IRQ Holder for PCI Steering |
| IRQ9 | PCI-1131 CardBus Controller |
| IRQ9 | Video Controller |
| IRQ11 | Intel PCI to USB Universal Host Controller |
| IRQ11 | IRQ Holder for PCI Steering |
| IRQ12 | PS/2 TouchPad/Mouse |
| IRQ13 | Numeric data processor |
| IRQ14 | Intel PCI Bus Master IDE Controller |
| IRQ14 | Primary IDE Controller (dual fifo) |
| IRQ15 | Intel PCI Bus Master IDE Controller |
| IRQ15 | Secondary IDE Controller (dual fifo) |

System DMA

| System DMA | |
|--------------|------------------|
| Hardware DMA | System Function |
| DMA 0 | Audio Controller |
| DMA 1 | Audio Controller |
| DMA 2 | Diskette Drive |
| DMA 4 | DMA Controller |

System I/O Address

| System I/O Address | |
|--------------------|--|
| I/O Address (Hex) | System Function (Shipping Configuration) |
| 0000h-000Fh | DMA Controller |
| 0020h-0021h | Interrupt Controller |

| | |
|-------------|--|
| 0040h-0043h | System timer |
| 0060h-0060h | Keyboard Controller |
| 0061h-0061h | System speaker |
| 0064h-0064h | Standard 101/102-Key or Microsoft Natural Keyboard |
| 0070h-0071h | System CMOS/real time clock |
| 0080h-0080h | Motherboard resources |
| 0081h-008Fh | DMA Controller |
| 00A0h-00A1h | Programmable interrupt controller |
| 00C0h-00DFh | DMA |
| 00ECh-00EFh | Motherboard resources |
| 00F0h-00FFh | Numeric data processor |
| 0170h-0177h | Intel PCI Bus Master IDE Controller |
| 0170h-0177h | Secondary IDE Controller (dual fifo) |
| 01F0h-01F7h | Intel PCI Bus Master IDE Controller |
| 01F0h-01F7h | Primary IDE Controller (dual fifo) |
| 0201h-0201h | Gameport Joystick |
| 0220h-022Fh | ES1869 Plug and Play AudioDrive |
| 02F8h-02FFh | Compaq Presario 56K-DF |
| 0330h-0331h | ES1869 Plug and Play AudioDrive |
| 0376h-0376h | Secondary IDE controller (dual fifo) |

| | |
|-------------|--|
| 0376h-0376h | Intel PCI Bus Master IDE Controller |
| 0378h-037Fh | Printer Port (LPT1) |
| 0388h-038Bh | ES1869 Plug and Play AudioDrive |
| 03B0h-03BBh | Video Controller |
| 03C0h-03DFh | Video Controller |
| 03F0h-03F5h | Standard Floppy Disk Controller |
| 03F6h-03F6h | Intel PCI Bus Master IDE Controller |
| 03F6h-03F6h | Primary IDE controller (dual fifo) |
| 03F7h-03F7h | Standard Floppy Disk Controller |
| 03F8h-03FFh | Communications Port (COM1) |
| 04D0h-04D1h | Motherboard resources |
| 0800h-0807h | ES1869 Control Interface |
| 0CF8h-0CFFh | PCI bus |
| 2180h-218Fh | Motherboard resources |
| 8000h-803Fh | Motherboard resources |
| FCD0h-FCD7h | Primary IDE controller (dual fifo) |
| FCD0h-FCDFh | Intel PCI Bus Master IDEController |
| FCD8h-FCDFh | Secondary IDE controller (dual fifo) |
| FCE0h-FCFFh | Intel PCI to USB Universal Host Controller |

System Memory Catalog

| System Memory Catalog | |
|-----------------------|---|
| Memory Address | System Function |
| 00000000h-0009FFFFh | System board extension for PnP BIOS |
| 000A0000h-000AFFFFh | Graphics Controller |
| 000B0000h-000BFFFFh | Graphics Controller |
| 000C0000h-000CBFFFh | Graphics Controller |
| 000DC000h-000FFFFFh | System board extension for PnP BIOS |
| 00100000h-03FFFFFFh | System board extension for PnP BIOS |
| 05000000h-05000FFFh | PCI-1131 CardBus Controller |
| 05001000h-05001FFFh | PCI-1131 CardBus Controller |
| 80000000h-803FFFFFFh | Intel Pentium(r) II Processor to PCI bridge |
| FD000000h-FDFFFFFFh | Graphics Controller |
| FEA00000h-FEBFFFFFFh | Graphics Controller |
| FED00000h-FEDFFFFFFh | Graphics Controller |
| FFF80000h-FFFFFFFFh | Motherboard resources |

Display (Information not available)

| 13.3" (Diagonal) TFT Display | | |
|---|------------------------------|------------------------------|
| | U.S. | Metric |
| Dimensions Height Width | Information not available | Information not available |
| Display Dimensions Width Height Depth | Information not available | Information not available |
| Weight | Information not available | Information not available |
| Contrast Ratio | Information not available | Information not available |
| Brightness | Information not available | Information not available |
| Total Power Consumption | Information not available | Information not available |

| 12.1" (Diagonal) TFT Display | | |
|---|---------------------------|---------------------------|
| | U.S. | Metric |
| Dimensions Height Width | Information not available | Information not available |
| Display Dimensions Width Height Depth | Information not available | Information not available |
| Weight | Information not available | Information not available |
| Contrast Ratio | Information not available | Information not available |
| Brightness | Information not available | Information not available |
| Total Power Consumption | Information not available | Information not available |

Memory Expansion

| Memory Expansion | | |
|------------------|------------------------|--------------|
| System Memory | Expansion Board Memory | Total Memory |
| 32-MB | 16-MB | 48-MB |
| 32-MB | 32-MB | 64-MB |
| 32-MB | 64-MB | 96-MB |

Diskette Drive (Information not available)

| Diskette Drive | |
|--|---------------------------|
| Capacity per Diskette (High/Low) | Information not available |
| Diskette Size | Information not available |
| Number of LED Indicators (Read/Write) | Information not available |
| Number of Drives Supported | Information not available |
| Drive Rotation (rpm) | Information not available |
| Transfer Rate (Kbps) | Information not available |
| Bytes per Sector | Information not available |
| Sectors per Track (High/Low) | Information not available |
| Tracks per Side (High/Low) | Information not available |

| | |
|---|---------------------------|
| Access Times Track-to-Track (ms) Average (ms) Setting Time (ms) Latency Average (ms) | Information not available |
| Cylinders (High/Low) | Information not available |
| Number of Read/Write Heads | Information not available |

Hard Drive (Information not available)

| Hard Drives | | |
|--|---------------------------|---------------------------|
| | 5.0-GB | 4.0-GB |
| Capacity Per Drive | Information not available | Information not available |
| Drive Type | Information not available | Information not available |
| Logical Configuration Cylinders Heads Sectors per track Bytes per sector | Information not available | Information not available |
| Seek Times (Typical, Including settling in ms) Single track Average Full stroke | Information not available | Information not available |
| Transfer Rate At interface | Information not available | Information not available |

CD Drive (Information not available)

| CD Drive | | |
|--|---------------------------|--|
| | 24x CD Drive | |
| Dimensions | Information not available | |
| Weight | Information not available | |
| Rotational Speed | Information not available | |
| Typical Transfer Rate Sustained Data Transfer Rate | Information not available | |
| Access Time Average Random Access Time | Information not available | |
| Spin Up time | Information not available | |
| Data Buffer Capacity | Information not available | |

Battery Pack

| Battery Pack | | |
|------------------------------------|------------------------------------|-------------------------------|
| | Nickel Metal Hydride (NiMH) | Lithium Ion (Li ion) * |
| Dimensions | | |
| Height | 0.8 in (20.3 mm) | 0.8 in (20.3 mm) |
| Length | 5.7 in (145 mm) | 5.7 in (145 mm) |
| Width | 3.1 in (78.7 mm) | 3.1 in (78.7 mm) |
| Weight | 1.01 lb (458.1 g) | 0.90 lb (408.2 g) |
| Battery Pack Operating Time | 2:30 hr | 3:00 hr |
| Energy | | |
| Nominal Open Circuit Voltage | 9.6 V | 14.4 V |
| Capacity | 3200mAH | 2500mAH |
| Power | 40 W | 40 W |
| Environmental Requirements | | |
| Operating Temperature | 32° F (0-50° C) | 32° F (0-50° C) |
| Non-operating Temperature | -20° C -60° C | -20° C -60° C |
| Charging Temperature | 5° C-45° C | 5° C-45° C |

1.800.AT.COMPAQ

[privacy and legal statement](#)

Maintenance & Service Guide

Presario 1600 Series

Models: 1650 and 1655

[Home Page](#) | [Notice](#) | [Preface](#) | [Product Description](#) | [Troubleshooting](#)
[Illustrated Parts Catalog](#) | [Removal & Replacement Procedures](#) | [Specifications](#)
[Pin Assignments](#) | [Battery Pack Operations](#)

Connector Pin Assignments

This appendix provides connector pin assignment tables for Compaq Presario 1600 Series Portable Computers. For more information on connectors, refer to the section on [Rear Connectors](#).

NOTE: The signals in all tables of this appendix are considered active high unless otherwise indicated by an asterisk (*).

Parallel Connector



| Pin | Signal | Pin | Signal |
|-----|------------|-------|---------------------|
| 1 | Strobe* | 10 | Acknowledge* |
| 2 | Data Bit 0 | 11 | Busy |
| 3 | Data Bit 1 | 12 | Paper Out |
| 4 | Data Bit 2 | 13 | Select |
| 5 | Data Bit 3 | 14 | Auto Linefeed* |
| 6 | Data Bit 4 | 15 | Error* |
| 7 | Data Bit 5 | 16 | Initialize Printer* |
| 8 | Data Bit 6 | 17 | Select In* |
| 9 | Data Bit 7 | 18-25 | Signal Ground |

* = Active low

Serial Connector

| Connector | Pin | Signal |
|--|-----|---------------------|
|  | 1 | Carrier Detect |
| | 2 | Receive Data |
| | 3 | Transmit Data |
| | 4 | Data Terminal Ready |
| | 5 | Signal Ground |
| | 6 | Data Set Ready |
| | 7 | Ready to Send |
| | 8 | Clear to Send |
| | 9 | Ring Indicator |

Keyboard/Mouse

| Connector | Pin | Signal |
|--|-----|-------------|
|  | 1 | Data |
| | 2 | Not defined |
| | 3 | Ground |
| | 4 | +5 VDC |
| | 5 | Clock |
| | 6 | Not defined |

External VGA Monitor

| Connector | Pin | Signal |
|-----------|-----|--------|
|-----------|-----|--------|



| | |
|----|-----------------|
| 1 | Red Analog |
| 2 | Green Analog |
| 3 | Blue Analog |
| 4 | Not connected |
| 5 | Ground |
| 6 | Ground Analog |
| 7 | Ground Analog |
| 8 | Ground Analog |
| 9 | Not connected |
| 10 | Ground |
| 11 | Monitor Detect |
| 12 | DDC2B Data |
| 13 | Horizontal Sync |
| 14 | Vertical Sync |
| 15 | DDC2B Clock |

Universal Serial Bus

Connector

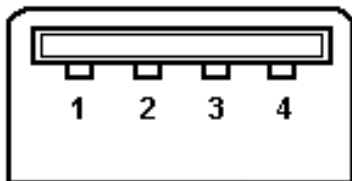

| Pin | Signal |
|----------|--------|
| 1 Ground | |
| 2 D+ | |
| 3 D- | |
| 4 Power | |

Port Replicator

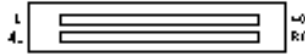

| Pin | Signal | Pin | Signal | Pin | Signal | Pin | Signal |
|-----|-----------------|-----|----------------|-----|-----------|-----|---------|
| 1 | N.C. | 21 | Printer Data 0 | 41 | N.C. | 61 | CTS |
| 2 | N.C. | 22 | Printer Data 1 | 42 | N.C. | 62 | DCD |
| 3 | Kb Clk 1 | 23 | Printer Data 2 | 43 | Switch A | 63 | DSR |
| 4 | Joystick Data A | 24 | Printer Data 3 | 44 | Switch B | 64 | TXD |
| 5 | Kb Data 1 | 25 | Printer Data 4 | 45 | Switch C | 65 | RTS |
| 6 | Joystick Data B | 26 | Printer Data 5 | 46 | Switch D | 66 | N.C. |
| 7 | Kb Clk 2 | 27 | Printer Data 6 | 47 | N.C. | 67 | Detect |
| 8 | Joystick Data C | 28 | Printer Data 7 | 48 | MIDI In | 68 | N.C. |
| 9 | Kb Data 2 | 29 | USB 0 - | 49 | MIDI Out | 69 | V. Sync |
| 10 | Joystick Data D | 30 | USB 0 + | 50 | +5V | 70 | Ground |
| 11 | Lp Select In | 31 | USB 1 - | 51 | +5V | 71 | H. Sync |
| 12 | Lp Paper End | 32 | USB 1 + | 52 | N.C. | 72 | Ground |
| 13 | Lp Initialize | 33 | Adapter In | 53 | N.C. | 73 | Blue |
| 14 | Lp Busy | 34 | Adapter In | 54 | N.C. | 74 | Ground |
| 15 | Lp Error | 35 | Adapter In | 55 | N.C. | 75 | Green |
| 16 | Lp Ack | 36 | Adapter In | 56 | Dock ID - | 76 | Ground |
| 17 | Lp Auto Feed | 37 | Adapter In | 57 | RXD | 77 | Red |
| 18 | Lp Strobe | 38 | Adapter In | 58 | Lp Select | 78 | Ground |
| 19 | DDC2BC | 39 | N.C. | 59 | RI | 79 | N.C. |
| 20 | DDC2BD | 40 | N.C. | 60 | DTR | 80 | N.C. |

Modem

| Connector | Pin | Signal |
|-----------|-----|--------|
|-----------|-----|--------|

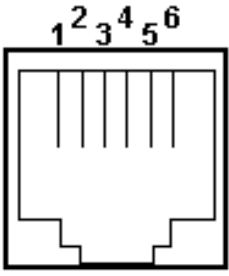

| | |
|---|--------|
| 1 | Unused |
| 2 | Unused |
| 3 | Tip |
| 4 | Ring |
| 5 | Unused |
| 6 | Unused |

1.800.AT.COMPAQ

[privacy and legal statement](#)

Maintenance & Service Guide

Presario 1600 Series

Models: 1650 and 1655

[Home Page](#) | [Notice](#) | [Preface](#) | [Product Description](#) | [Troubleshooting](#)
[Illustrated Parts Catalog](#) | [Removal & Replacement Procedures](#) | [Specifications](#)
[Pin Assignments](#) | [Battery Pack Operations](#)

Battery Pack Operating Time

This appendix covers the following information concerning battery pack operating time:

- Increase battery pack operating time
- Conditioning a battery pack
- Disposal of a used battery pack

Increasing Battery Pack Operating Time

Battery pack operating time differs depending on several variables. To avoid unnecessary replacement, consider the following variables when determining how long a charged battery pack should last:

- Power management settings
- Hardware configuration
- Software applications
- Installed options
- Display brightness
- Hard drive usage
- Changes in operating temperature
- Type and number of installed PC Cards

NOTE: The power consumption requirements for PC Cards vary widely. Some cards drain the battery pack very rapidly.

Battery pack operating time can be increased by as much as 50 percent by controlling the energy required by the computer and the energy stored in the battery pack.

Minimizing the Energy Required

To minimize the energy required by the computer, follow these steps:

- Set the power conservation levels in the Power Management utility to **Maximum**.
- Customize the timeout value to work more efficiently with the applications. The amount of battery life depends on the values selected.

Maximizing the Energy Stored

To maximize the energy stored in the battery pack, follow these guidelines:

- Condition the battery pack at least every 30 days to improve overall battery performance.
- Keep a battery pack in the computer when using it with AC power to supply the battery pack with a constant trickle charge.
- Store the battery pack in a cool, dry place when not in use.

Conditioning a Battery Pack

CAUTION: To avoid a loss of data, ensure that all data is saved before discharging a battery pack.



To condition a battery pack, complete the following steps:

1. Plug in the AC adapter and allow the battery to charge until the fast charge arrow on the display disappears. Your battery gauge may read 100 percent for a period of time before the arrow disappears. Do not unplug the AC adapter until the arrow disappears.
2. Unplug the AC adapter and allow the battery to drain until the computer reaches hibernation and turns itself off. **Do not plug in the AC adapter during this process or you will need to restart with Step No. 1.** You may use the computer while the battery is draining.
3. Your battery is re- conditioned.
4. Plug in the AC adapter and begin using the computer.

The table below shows battery pack charge times by model.

| Battery Charge Time | | |
|-----------------------------|---------------------------------|----------|
| Computer | On Line | Off Line |
| Model 1/NiMH Battery Pack | 4.0 hours premature termination | 2:00 hr |
| Model 2/Li ion Battery Pack | 4.5 hours premature termination | 2:50 hr |

Disposal of a Used Battery Pack

In the interest of safeguarding our environment, Compaq Computer Corporation recommends that nickel metal hydride (NiMH) and lithium ion (Li ion) battery packs be recycled. Battery packs should be handled in accordance with country, state, province, or local regulations.



CAUTION: Never attempt to open or service a battery pack. Opening a battery pack not only damages the pack and makes it unusable, but also expose potentially harmful battery components.

[Top of Page](#)

1.800.AT.COMPAQ

[privacy and legal statement](#)

COMPAQ

[STORE](#) | [PRODUCTS](#) | [SERVICES](#) | [SUPPORT](#) | [CONTACT US](#) | [SEARCH](#)

Maintenance & Service Guide

Presario 1600 Series

Models: 1650 and 1655

[Home Page](#) | [Notice](#) | [Preface](#) | [Product Description](#) | [Troubleshooting](#)
[Illustrated Parts Catalog](#) | [Removal & Replacement Procedures](#) | [Specifications](#)
[Pin Assignments](#) | [Battery Pack Operations](#)

Models and Features

Models and Features

[Controls and Lights](#)

[Left Side Components](#)

[Right Side Components](#)

[Bottom of Unit](#)

[Rear Connectors](#)

[Port Replicator](#)

[Power Management for Windows 98](#)

Compaq Presario 1600 Series Portable Computer Models

| | Model 1650 | Model 1655 |
|-------------------|--|---------------------------|
| Display | 12. 1" TFT | 13. 3" TFT |
| Processor | 266 Pentium II | 266 Pentium II |
| Hard Drive | 4.0-GB | 4.0-GB |
| CD Drive | 24× MAX | 24× MAX |
| Modem | M+ -56.0 Kbps or K-56.0 Kbps with ITU V.90 | K-56.0 Kbps with ITU V.90 |

1.800.AT.COMPAQ

[privacy and legal statement](#)

COMPAQ

[STORE](#) | [PRODUCTS](#) | [SERVICES](#) | [SUPPORT](#) | [CONTACT US](#) | [SEARCH](#)

Maintenance & Service Guide

Presario 1600 Series

Models: 1650 and 1655

| [Home Page](#) | [Notice](#) | [Preface](#) | [Product Description](#) | [Troubleshooting](#)
[Illustrated Parts Catalog](#) | [Removal & Replacement Procedures](#) | [Specifications](#)
[Pin Assignments](#) | [Battery Pack Operations](#)

Controls and Lights

[Models and Features](#)

[Controls and Lights](#)

[Left Side Components](#)

[Right Side Components](#)

[Bottom of Unit](#)

[Rear Connectors](#)

[Port Replicator](#)

[Power Management for Windows 98](#)

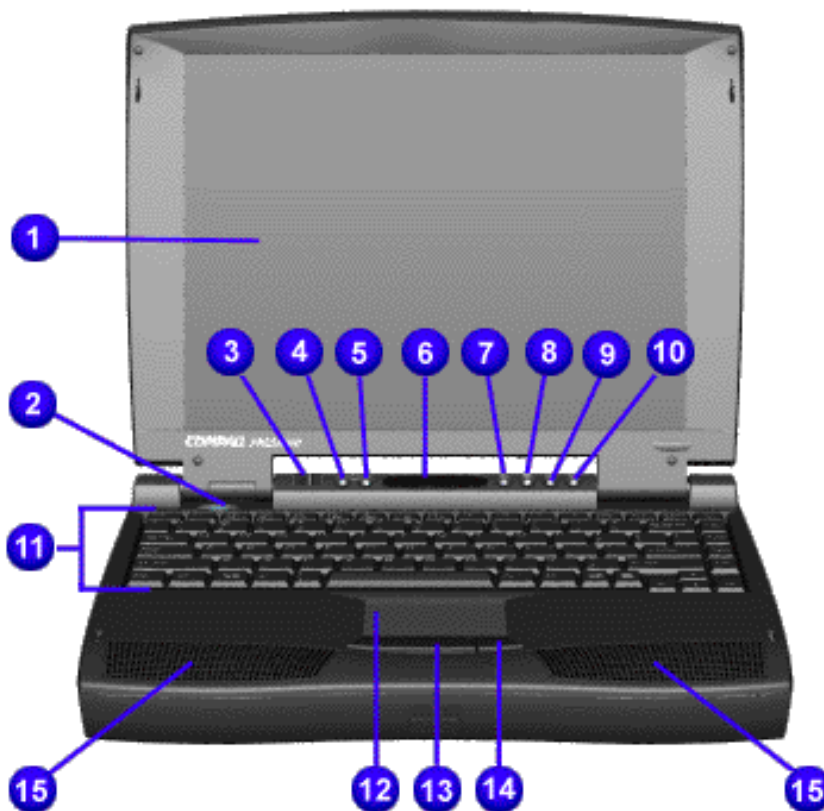

Front of Unit

| | |
|-------------------------------|----------------------------|
| 1. Display | 9. CD Previous Track |
| 2. Power (On/Off) Button | 10. CD Next Track |
| 3. Display Switch | 11. Keyboard |
| 4. Volume Control Down Button | 12. Touch Pad |
| 5. Volume Control Up Button | 13. Left Touch Pad Button |
| 6. Status Panel | 14. Right Touch Pad Button |
| 7. CD Play/Pause | 15. Integrated Speakers |
| 8. CD Stop | |

1.800.AT.COMPAQ

[privacy and legal statement](#)

COMPAQ

[STORE](#) | [PRODUCTS](#) | [SERVICES](#) | [SUPPORT](#) | [CONTACT US](#) | [SEARCH](#)

Maintenance & Service Guide

Presario 1600 Series

Models: 1650 and 1655

[Home Page](#) | [Notice](#) | [Preface](#) | [Product Description](#) | [Troubleshooting](#)
[Illustrated Parts Catalog](#) | [Removal & Replacement Procedures](#) | [Specifications](#)
[Pin Assignments](#) | [Battery Pack Operations](#)

Left Side Components

[Models and Features](#)

[Controls and Lights](#)

[Left Side Components](#)

[Right Side Components](#)

[Bottom of Unit](#)

[Rear Connectors](#)

[Port Replicator](#)

[Power Management for Windows 98](#)

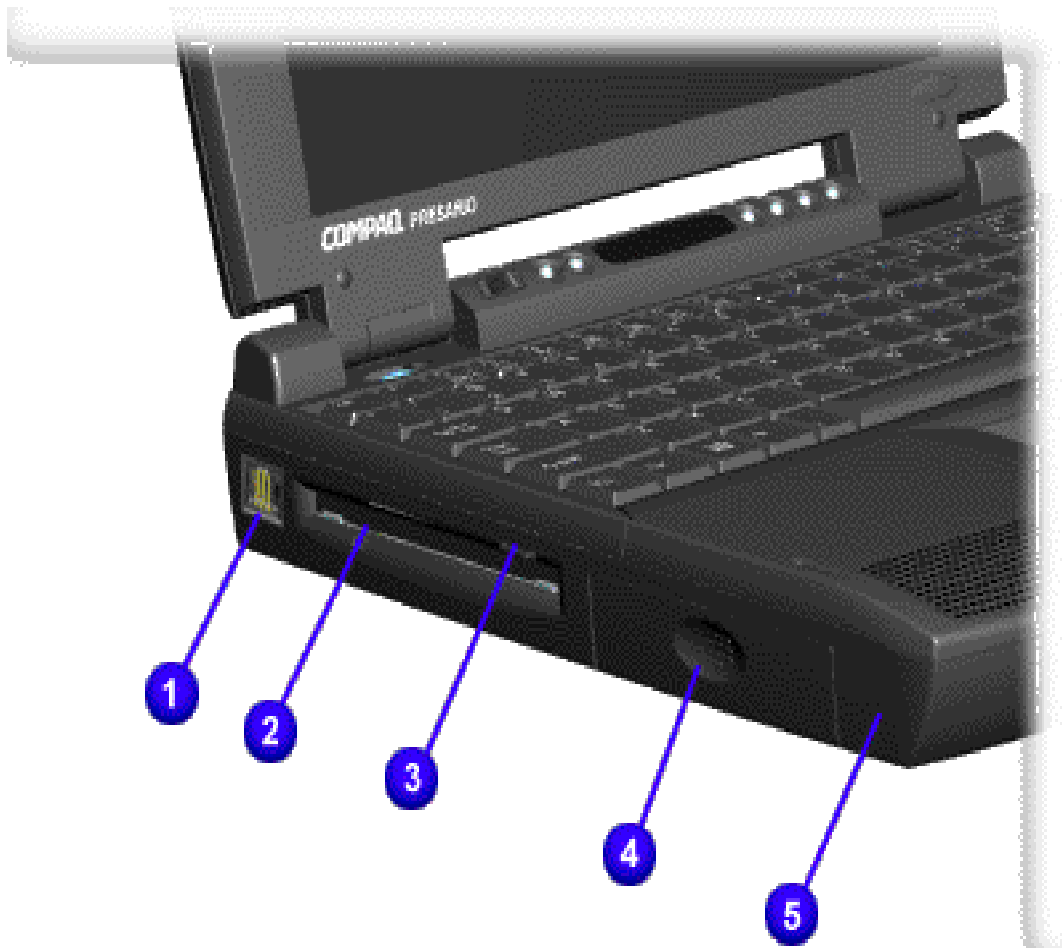

1. Modem Jack

2. Diskette Drive Slot

3. Diskette Eject Button

4. Battery Pack

5. Left Speaker Port

1.800.AT.COMPAQ



[privacy and legal statement](#)

Maintenance & Service Guide

Presario 1600 Series

Models: 1650 and 1655

[Home Page](#) | [Notice](#) | [Preface](#) | [Product Description](#) | [Troubleshooting](#)
[Illustrated Parts Catalog](#) | [Removal & Replacement Procedures](#) | [Specifications](#)
[Pin Assignments](#) | [Battery Pack Operations](#)

Right Side Components

| |
|---|
| Models and Features |
| Controls and Lights |
| Left Side Components |
| Right Side Components |
| Bottom of Unit |
| Rear Connectors |
| Port Replicator |
| Power Management for Windows 98 |

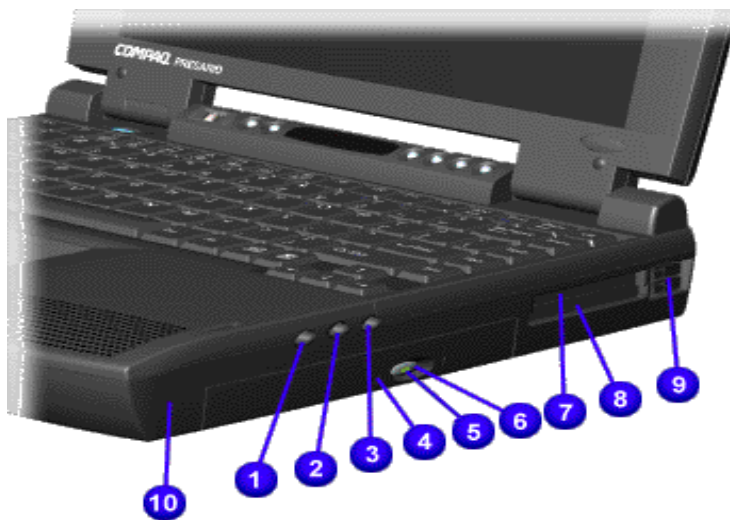

| | |
|-----------------------------|-------------------------|
| 1. Headphone Out | 6. Manual Eject Hole |
| 2. Line-In Jack | 7. PCMCIA (Top Slot) |
| 3. External Microphone Jack | 8. PCMCIA (Bottom Slot) |
| 4. CD Drive | 9. PCMCIA Eject Levers |
| 5. CD Drive Eject Button | 10. Right Speaker Port |

1.800.AT.COMPAQ

[privacy and legal statement](#)

COMPAQ

[STORE](#) | [PRODUCTS](#) | [SERVICES](#) | [SUPPORT](#) | [CONTACT US](#) | [SEARCH](#)

Maintenance & Service Guide

Presario 1600 Series

Models: 1650 and 1655

[Home Page](#) | [Notice](#) | [Preface](#) | [Product Description](#) | [Troubleshooting](#)
[Illustrated Parts Catalog](#) | [Removal & Replacement Procedures](#) | [Specifications](#)
[Pin Assignments](#) | [Battery Pack Operations](#)

Bottom of Unit

[Models and Features](#)

[Controls and Lights](#)

[Left Side Components](#)

[Right Side Components](#)

[Bottom of Unit](#)

[Rear Connectors](#)

[Port Replicator](#)

[Power Management for Windows 98](#)

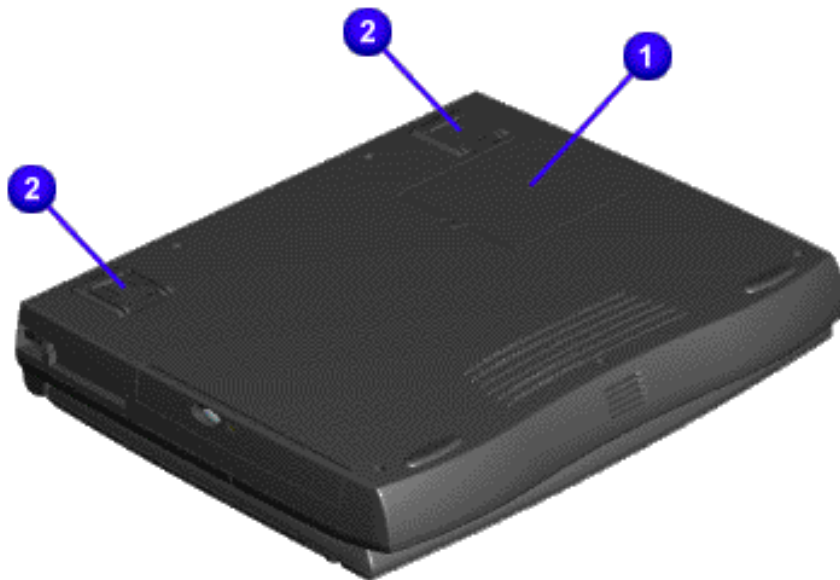

| | |
|-----------------------|---------|
| 1. Memory Compartment | 2. Feet |
|-----------------------|---------|

1.800.AT.COMPAQ

[privacy and legal statement](#)

Maintenance & Service Guide

Presario 1600 Series

Models: 1650 and 1655

[Home Page](#) | [Notice](#) | [Preface](#) | [Product Description](#) | [Troubleshooting](#)
[Illustrated Parts Catalog](#) | [Removal & Replacement Procedures](#) | [Specifications](#)
[Pin Assignments](#) | [Battery Pack Operations](#)

Rear Connectors

[Models and Features](#)

[Controls and Lights](#)

[Left Side Components](#)

[Right Side Components](#)

[Bottom of Unit](#)

[Rear Connectors](#)

[Port Replicator](#)

[Power Management for Windows 98](#)

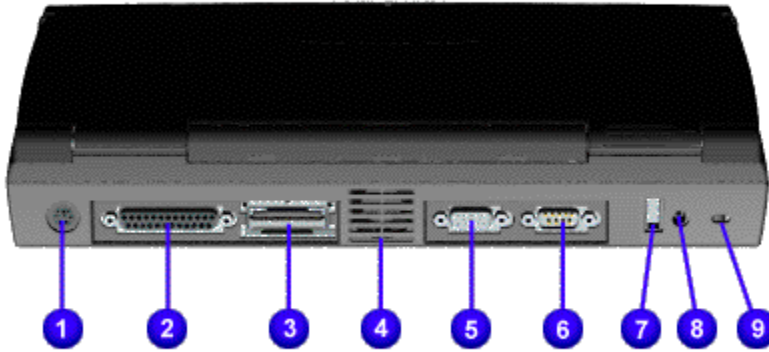

| | |
|--------------------------|--------------------------|
| 1. Keyboard/ Mouse Port | 6. External Monitor Port |
| 2. Parallel Printer Port | 7. USB |
| 3. Port Replicator | 8. AC Adapter |
| 4. Fan Exhaust | 9. Security Slot |
| 5. Serial Port | |

1.800.AT.COMPAQ

[privacy and legal statement](#)

Maintenance & Service Guide

Presario 1600 Series

Models: 1650 and 1655

| [Home Page](#) | [Notice](#) | [Preface](#) | [Product Description](#) | [Troubleshooting](#)
[Illustrated Parts Catalog](#) | [Removal & Replacement Procedures](#) | [Specifications](#)
[Pin Assignments](#) | [Battery Pack Operations](#)

Port Replicator

[Models and Features](#)

[Controls and Lights](#)

[Left Side Components](#)

[Right Side Components](#)

[Bottom of Unit](#)

[Rear Connectors](#)

Port Replicator

[Power Management for Windows 98](#)

This section is an overview of the Compaq Presario 1600 Series Portable Computer Port Replicator and covers the following topics:

- [System Overview](#)
- [Features](#)
- [Port Replicator Rear Connectors](#)
- [80-Pin Connectors](#)

System Overview

A manual docking mechanism on the Compaq Presario 1600 Series Portable Computer Port Replicator docks Compaq Presario 1600 Series Portable Computers. When the computer is docked, the [80-pin external](#) options connector handles the entire electrical interface (both power and signal connections) between the computer and the Port Replicator Rear.

Features

The Compaq Presario 1600 Series Portable Computer Port Replicator provides all the connectors supported by the Compaq Presario 1600 Series Portable Computers. They include:

- External keyboard
- External mouse
- MIDI/game port
- External monitor
- Serial
- Parallel
- AC Adapter
- Dual USB ports (Not supported on all models.)

| | | | | | |
|-----------------------------|------------------------|--------------------------|-------------------------|---------------------------|----------------------------|
| Compaq Home | Search | Products | Service | Worldwide | Compaq.com |
|-----------------------------|------------------------|--------------------------|-------------------------|---------------------------|----------------------------|

[Comments?](#)

[Legal Notices and Privacy Statement](#)

Revised: dd Month 1998

[1.800.AT.COMPAQ](#)

[privacy and legal statement](#)

Maintenance & Service Guide

Presario 1600 Series

Models: 1650 and 1655

| [Home Page](#) | [Notice](#) | [Preface](#) | [Product Description](#) | [Troubleshooting](#)
[Illustrated Parts Catalog](#) | [Removal & Replacement Procedures](#) | [Specifications](#)
[Pin Assignments](#) | [Battery Pack Operations](#)

Power Management for Windows 98

The following power management features are available for conserving AC power and extending battery operating time:

- Power Management Settings
- [Sleep](#)
- [Hibernation](#)
- [Battery operating time](#)
- [Rebooting After a Lockup](#)
- [Servicing Your Computer - Full Off Mode](#)

Power Management Settings

Depending on your patterns of computer use, you can set different levels of power management. These different power management levels can be activated based on the amount of time passed since the last system activity. System activity examples, include keyboard or mouse movement, CD (while under program control that monitors Sleep), and modem use.

You can select different conditions or power schemes through Power Management..The optional settings are **Home/Office Desk**, **Portable/ Laptop** and **Always On**. From the default settings, you can change the following settings.

- the System goes to Sleep (Standby) mode
- the screen times out and goes blank
- the hard drive spins down

Each of these system components will go to sleep after the selected or default periods of inactivity. (The setting for hard drive must be less than or equal to the setting for System.)

IMPORTANT: If you're on a network, it's recommended that you set **System Standby** to **Never**.

There are five categories of power management settings under the Control Panel. The default setting for each feature is listed below in the tables.

Power Management Properties

Tab: **Power Schemes:**

Plugged in

Running on Batteries

| | | |
|----------------------------------|------------------|------------------|
| Always on System Standby: | Never | 15 minutes |
| Turn OFF Monitor | After 15 minutes | After 10 minutes |
| Always on System Standby: | After 15 minutes | After 10 minutes |

Power Management Properties

Tab: **ALARMS:**

| | |
|-------------------------------|-------------------------------------|
| Low Battery Alarm: | 10% |
| Critical Battery Alarm | 0% |
| Alarm Actions: | X Display Message Notification |
| | Text Action No Action |

Power Management Properties

| | |
|--------------------------|---------|
| Tab: POWER METER: | Default |
| Tab: ADVANCED | Default |

Display Properties

Tab: **POWER METER: Monitor** Laptop Display (Maximum resolution according to unit display size)

System Properties

Tab: Device Manager Default:

| | |
|---------------------|---|
| Disk Drives: | <input checked="" type="checkbox"/> DMA |
| CD ROM: | <input checked="" type="checkbox"/> DMA |

Sleep

You can select Sleep mode instead of turning off the computer when you have finished using it. This allows the computer to wake up faster than turning it completely off and saves power over the active (On) mode. Compaq Presario Notebook computers have two levels of sleep, Hibernation and Sleep.

Hibernation - by pushing the power button once your computer will perform a save to disk followed by a shut down of the computer into Off mode.

Sleep - is a low power mode, also referred to as Standby mode. While in Sleep mode, your computer will maintain system information and open files. Unsaved information will be lost if you turn off your system prior to system wake-up, or if you lose power while using the AC adapter.



CAUTION: While in Sleep mode, your computer will maintain system information and open files. Unsaved information will be lost if you turn off your system prior to system wake-up, or if you lose power while using the AC adapter.

Hibernation Mode

Hibernation helps conserve battery life and protects your data. Hibernation can be a routine power saving event, or can be the result of a low battery condition. As it enters Hibernation, your computer will display a progress screen, as it automatically saves the machine state before it shuts down and turns itself off. Your computer will automatically go into Hibernation, when the battery has little power left, or when the system (operating on battery power) has been in Sleep mode for more than an hour. You can also manually initiate Hibernation by pressing the power button once while the system is active. To restore the computer's previous state, simply press the power button once again. While waking up, the computer will display a progress screen.

The following table shows the conditions and indicators for getting in and out of the various power management modes, Sleep, Hibernation and Off.

| Mode | To Initiate | To End | Indicators |
|-----------|---|-------------------------|----------------------------|
| Sleep | <u>Manual keys combination</u> - Fn+F4 | Press any key | Flashing green Power LED |
| | <u>Time Out Default</u> 15 minutes. If on Battery power (system will not go to Sleep if on AC power) | | |
| Hibernate | <u>Manual</u> - Press Power Button once | Press Power Button once | No Power LED, blank screen |
| | <u>Time Out Default</u> If low battery or after 1 hour of sleep (system will not Hibernate if on AC power) | | |
| Off | Perform normal Windows shutdown via the start button, or press and hold down the power button for 4 seconds | Press Power Button once | No Power LED, blank screen |

Servicing Your Computer - Full Off Mode

If you need to install or replace components in your system, you must turn the computer off *completely*. Follow the instructions above for properly putting the computer into Off mode, unplug from the outlet and remove the battery

[\(see battery section for instruction on removing battery\).](#)

Rebooting After a Lockup

Occasionally you may encounter a frozen keyboard or a locked screen. To reboot your computer (as if from a cold start) press and hold down the Power Button for at least four seconds, which will cause a manual shutdown. Then, restart it with a single press of the Power Button. If it still doesn't recover, press the Power Button and hold it for four seconds to shut it down, then, remove the battery or unplug the AC power for at least 30 seconds. Reinsert the battery or reconnect AC power and press the Power Button once to reboot.

Battery Operating Time

Battery operating time is affected by variables, such as the following:

- Power conservation settings
- Hardware configuration
- Software applications
- Installed options
- Display brightness
- Hard drive usage
- Power button
- Changes in operating temperature
- Type and number of installed PC Cards

For more information on increasing battery pack operating time, conditioning the battery pack, and disposing of a used battery pack, refer to the [Battery Pack Operations](#).

1.800.AT.COMPAQ

[privacy and legal statement](#)

COMPAQ

[STORE](#) | [PRODUCTS](#) | [SERVICES](#) | [SUPPORT](#) | [CONTACT US](#) | [SEARCH](#)

Maintenance & Service Guide

Presario 1600 Series

Models: 1650 and 1655

| [Home Page](#) | [Notice](#) | [Preface](#) | [Product Description](#) | [Troubleshooting](#)
[Illustrated Parts Catalog](#) | [Removal & Replacement Procedures](#) | [Specifications](#)
[Pin Assignments](#) | [Battery Pack Operations](#)

Preliminary Steps

Before running [POST](#), complete the following preliminary steps:

1. If a power-on password has been established, type the password and press the **Enter** key. If the password is not known, [clear the password](#).
2. Run [Computer Checkup](#).
3. Turn off the computer and its external devices.
4. Disconnect any external devices that you do not want to test. Do not disconnect the printer if you want to test it or use it to log error messages.

IMPORTANT:

If the problem only occurs when an external device is connected to the computer, the problem may be related to the external device or its cable. Verify this by running POST with and without the external device connected.

5. Install loopback plugs in the serial and parallel connectors if you would like to test these ports.
6. Ensure the hard drive is installed in the computer.
7. Ensure that the battery pack is inserted in the computer and the computer is connected to an external AC power source.

When the preliminary steps are completed, you are ready to run [POST](#).

1.800.AT.COMPAQ

[privacy and legal statement](#)

Maintenance & Service Guide

Presario 1600 Series

Models: 1650 and 1655

[Home Page](#) | [Notice](#) | [Preface](#) | [Product Description](#) | [Troubleshooting](#)
[Illustrated Parts Catalog](#) | [Removal & Replacement Procedures](#) | [Specifications](#)
[Pin Assignments](#) | [Battery Pack Operations](#)

Clearing the Power-on Password

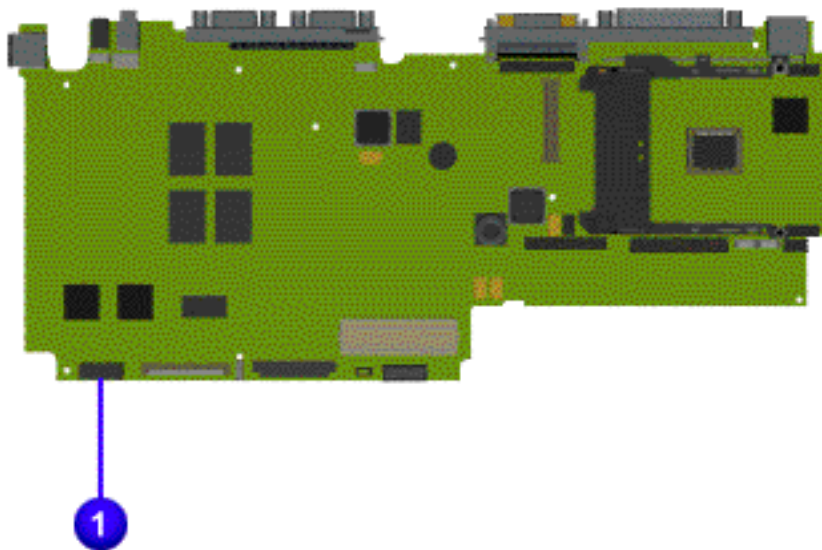

Clearing the power-on password requires removing all Setup attributes that are programmed in the CMOS.

If the password is not known, clear it by performing the following steps:

1. Turn off the computer.
2. Disconnect the power cord.
3. Remove the battery pack.
4. Remove the keyboard.
5. Remove the  RTC battery for 30 seconds. The password, together with other Setup attributes, will be cleared.
6. Reassemble the computer.
7. Turn on the computer to verify that the power-on password has been cleared. If it has not been cleared, repeat Steps 1 through 7.

1.800.AT.COMPAQ

[privacy and legal statement](#)

Maintenance & Service Guide

Presario 1600 Series

Models: 1650 and 1655

[| Home Page](#) | [| Notice](#) | [| Preface](#) | [| Product Description](#) | [| Troubleshooting](#)
[| Illustrated Parts Catalog](#) | [| Removal & Replacement Procedures](#) | [| Specifications](#)
[| Pin Assignments](#) | [| Battery Pack Operations](#)

Power-On Self Test (POST)

Running POST

To run POST, complete the following steps:

Turn off the computer, then turn on the computer.

If POST does not detect any errors, the computer will not beep. This indicates successful completion of POST test. POST has run successfully and boots from the hard drive (or from a bootable diskette if one is installed in the diskette drive).

If POST detects errors, the errors are indicated by screen and/or audible messages. Refer to "Power-On Self-Test (POST) Codes" in the tables for a list of POST codes and their relevant descriptions.

NOTE: If the system is not functioning well enough to run POST, or if the display is not functioning well enough to show POST error messages, refer to the Troubleshooting tables.

| Power-On Self-Test Messages | |
|---|--|
| 102-System Board Failure | |
| Probable Cause | Recommended Action |
| DMA, timers, etc. | Replace the system board. |
| 162-System Options Not Set | |
| Probable Cause | Recommended Action |
| Configuration incorrect | Run Computer Setup. |
| CMOS reflects that an invalid configuration has been set. | Run Computer Setup. |
| RAM failure | 1. Replace the memory modules. 2. Replace the system board. |
| Memory test data error | 1. Replace the memory modules. 2. Replace the system board. |
| XX000YZZ RAM failure | Replace the system board. |

XX000YZZ 201-Memory Error

| Probable Cause | Recommended Action |
|----------------|--------------------|
|----------------|--------------------|

301-Keyboard Error

| Probable Cause | Recommended Action |
|----------------|--------------------|
|----------------|--------------------|

| | |
|------------------|---|
| Keyboard failure | <ol style="list-style-type: none"> 1. Ensure the keys are not depressed during POST. 2. Reconnect the keyboard with the computer off. 3. Replace the keyboard. |
|------------------|---|

304-Keyboard or System Unit Error

| Probable Cause | Recommended Action |
|----------------|--------------------|
|----------------|--------------------|

| | |
|--------------------------------|---|
| Keyboard or system board error | <ol style="list-style-type: none"> 1. Replace the keyboard. 2. Replace the TouchPad or mouse. 3. Replace the system board. |
|--------------------------------|---|

601-Diskette Controller Error

| Probable Cause | Recommended Action |
|----------------|--------------------|
|----------------|--------------------|

| | |
|--|--|
| Mismatch in drive type or failure in the diskette controller | <ol style="list-style-type: none"> 1. Run Computer Checkup (TEST). 2. Check and/or replace cables. 3. Replace the system board. |
|--|--|

605-Diskette Drive Error

| Probable Cause | Recommended Action |
|----------------|--------------------|
|----------------|--------------------|

| | |
|------------------------|---------------------|
| Mismatch in drive type | Run Computer Setup. |
|------------------------|---------------------|

1780-Primary Hard Drive 0 Failure

| Probable Cause | Recommended Action |
|----------------|--------------------|
|----------------|--------------------|

| | |
|--------------------------|---|
| Disk 0 failed to respond | <ol style="list-style-type: none"> 1. Run Computer Checkup (TEST). 2. Replace the hard drive. |
|--------------------------|---|

| | |
|-------------------------|---|
| Hard drive format error | <ol style="list-style-type: none"> 1. Run Computer Checkup (TEST). 2. Replace the hard drive. |
|-------------------------|---|

1782-Hard Drive Controller

| Probable Cause | Recommended Action |
|----------------|--------------------|
|----------------|--------------------|

| | |
|-------------------------------|--|
| Hard drive controller failure | <ol style="list-style-type: none"> 1. Run Computer Setup. 2. Replace the hard drive. |
|-------------------------------|--|



[privacy and legal statement](#)

COMPAQ

[STORE](#) | [PRODUCTS](#) | [SERVICES](#) | [SUPPORT](#) | [CONTACT US](#) | [SEARCH](#)

Maintenance & Service Guide

Presario 1600 Series

Models: 1650 and 1655

| [Home Page](#) | [Notice](#) | [Preface](#) | [Product Description](#) | [Troubleshooting](#)
[Illustrated Parts Catalog](#) | [Removal & Replacement Procedures](#) | [Specifications](#)
[Pin Assignments](#) | [Battery Pack Operations](#)

Compaq Diagnostics

Compaq Diagnostics is installed on the hard drive of the computer. Run the Diagnostics utilities when you want to view or test system information and if you have installed or connected devices. If you run Compaq Diagnostics from a diskette, ensure that it is version 10.11 or later.

The Diagnostics menu includes the following utilities:

- [Computer Checkup \(TEST\)](#)
- [View System Information \(INSPECT\)](#)
- [Prepare Computer for a Compaq Service Call \(RemotePaq\)](#)

If you have a problem you cannot solve, run the Diagnostics utilities before you call for support. Run Computer Checkup and select to save the device list to a file and to print or to save the log of errors. Run the View System Information (INSPECT) utility and select to print or to save that information. Have the files or the printed information available when you call for support.

Computer Checkup (TEST)

Computer Checkup (TEST) determines whether the various computer components and devices are recognized by the system and are functioning properly. You can display, print, or save the information generated by Computer Checkup.

Follow these steps to run Computer Checkup:

1. Plug the computer into an external power source. (A low battery condition could interrupt

the program.)

2. Turn on the external devices that you want to test. Connect the printer if you want to print a log of error messages.
3. Insert the Compaq Diagnostics diskette in drive A.
4. Turn on or restart the computer. The computer starts from drive A, and the **Diagnostics Welcome** screen appears.
5. Press **Enter** to continue. The **Diagnostics** menu appears.
6. Select Computer Checkup from the **Diagnostics** menu. A **Test Option** menu appears.
7. Select **View the Device List** from the **Test Option** menu. A list of the installed Compaq devices appears.
8. If the list of installed devices is correct, select **OK**. The **Test Option** menu appears.

NOTE: If the list is incorrect, ensure that any new devices are installed properly.

9. Select one of the following from the **Test Option** menu:
 - Quick Check Diagnostics. Runs a quick, general test on each device with a minimal number of prompts. If errors occur, they display when the testing is complete. You cannot print or save the error messages.
 - Automatic Diagnostics. Runs unattended, maximum testing of each device with minimal prompts. You can choose how many times to run the tests, to stop on errors, or to print or save a log of errors.
 - Prompted Diagnostics. Allows maximum control over testing the devices. You can choose attended or unattended testing, decide to stop on errors, or choose to print or save a log of errors.
10. Follow the instructions on the screen as the devices are tested. When testing is complete, the **Test Option** menu appears.
11. Exit the **Test Option** menu.
12. Exit the **Diagnostics** menu.

View System Information (INSPECT)

The View System Information (INSPECT) utility provides information about the computer and installed or connected devices. You can display, print, or save the information.

Follow these steps to run View System Information (INSPECT) from the Compaq Diagnostics diskette:

1. Turn on the external devices that you want to test. Connect the printer if you want to print the information.
2. Insert the Compaq Diagnostics diskette in drive A.
3. Turn on or restart the computer. The computer starts from drive A, and the **Diagnostics Welcome** screen appears.
4. Press **Enter** to continue. The Diagnostics menu appears.
5. Select **View System Information (INSPECT)** from the **Diagnostics** menu.
6. Select the item you want to view from the following list:

| | |
|----------------|------------------|
| System | Memory |
| ROM | Audio |
| Keyboard | Operating system |
| System ports | System files |
| System storage | Windows files |
| Graphics | |

7. Follow the instructions on the screen to cycle through the screens, to return to the list and choose another item, or to print the information.

1.800.AT.COMPAQ

[privacy and legal statement](#)

COMPAQ

[STORE](#) | [PRODUCTS](#) | [SERVICES](#) | [SUPPORT](#) | [CONTACT US](#) | [SEARCH](#)

Maintenance & Service Guide

Presario 1600 Series

Models: 1650 and 1655

| [Home Page](#) | [Notice](#) | [Preface](#) | [Product Description](#) | [Troubleshooting](#)
[Illustrated Parts Catalog](#) | [Removal & Replacement Procedures](#) | [Specifications](#)
[Pin Assignments](#) | [Battery Pack Operations](#)

Diagnostic Error Codes

Diagnostic error codes occur if the system recognizes a problem while running the Compaq Diagnostic program. These error codes help identify possibly defective subassemblies.

The following tables list error codes, a description of the error condition, and the action required to resolve the error condition.

IMPORTANT: Retest the system after completing each step. If the problem has been resolved, do not proceed with the remaining steps.

For the removal and replacement of a particular subassembly, see [Removal and Replacement Procedures](#).

Select error codes by number or type:

[101 through 114](#)[Processor Test](#)[200 through 215](#)[Memory Test](#)[300 through 304](#)[Keyboard Test](#)[401 through 403](#)[Parallel Printer Test](#)[600 through 699](#)[Diskette Drive Test](#)[1101](#)[Serial Test](#)[1701 through 1736](#)[Hard Drive Test](#)

[501 through 516](#)

[Video Test](#)

[2402 through 2456](#)

[2458 through 2480](#)

[3206](#)

[Audio Test](#)

[8601 through 8602](#)

[Touch Pad Pointing Device Test](#)

[3301 through 6623](#)

[CD Test](#)

Processor Test Error Codes

| Error Code | Description | Recommended Action |
|------------|--|--|
| 101-xx | CPU test failed | Replace the processor and retest. |
| 102-xx | Coprocessor or Weitek Error | 1. Run the Configuration and Diagnostics Utilities. 2. Replace the processor board and retest. |
| 103-xx | DMA page registers test failed | Replace the system board and retest. |
| 104-xx | Interrupt controller master test failed | |
| 105-xx | Port 61 error | |
| 106-xx | Keyboard controller self-test failed | |
| 107-xx | CMOS RAM test failed | |
| 108-xx | CMOS interrupt test failed | |
| 109-xx | CMOS clock test failed | |
| 110-xx | Programmable timer load data test failed | |
| 113-xx | Protected mode test failed | 1. Check system configuration. 2. Verify cable connections to speaker. 3. Replace the system board and retest. |
| 114-01 | Speaker test failed | |

Memory Test Error Codes

| | | |
|--------|-----------------------------------|---|
| 200-xx | Memory machine ID test failed | 1. Flash the system ROM and retest. 2. Replace the system board and retest. |
| 202-xx | Memory system ROM checksum failed | |
| 203-xx | Write/Read test failed | 1. Remove the memory module and retest. 2. Install a new memory module and retest. |
| 204-xx | Address test failed | |
| 211-xx | Random pattern test failed | |
| 214-xx | Noise test failed | |

| | |
|--------|----------------------------|
| 215-xx | Random address test failed |
|--------|----------------------------|

Keyboard Test Error Codes

| | | |
|--------|--------------------------------|--|
| 300-xx | Failed ID Test | <ol style="list-style-type: none"> 1. Check the keyboard connection. If disconnected, turn off the computer and connect the keyboard. 2. Replace the keyboard and retest. 3. Replace the system board and retest. |
| 301-xx | Failed Selftest/Interface Test | |
| 302-xx | Failed Individual Key Test | |
| 304-xx | Failed Keyboard Repeat Test | |

Parallel Printer Test Error Codes

| | | |
|--------|---------------------------------|--|
| 401-xx | Printer failed or not connected | <ol style="list-style-type: none"> 1. Connect the printer. 2. Check power to the printer. 3. Install the loop-back connector and retest. 4. Check port and IRQ configuration. 5. Replace the system board and retest. |
| 402-xx | Failed Port Test | |
| 403-xx | Printer pattern test failed | |
| | | |

Diskette Drive Test

| | | | |
|--------|---|---|--|
| 600-xx | Diskette ID drive types test failed | <ol style="list-style-type: none"> 1. Replace the diskette media and retest. 2. Check and/or replace the diskette power and signal cables and retest. 3. Replace the diskette drive and retest. 4. Replace the system board and retest. | |
| 601-xx | Diskette format failed | | |
| 602-xx | Diskette read test failed | | |
| 603-xx | Diskette write, read, compare test failed | | |
| 604-xx | Diskette random read test failed | | |
| 605-xx | Diskette ID media failed | | |
| 606-xx | Diskette speed test failed | | |
| 609-xx | Diskette reset controller test failed | | |
| 610-xx | Diskette change line test failed | | |
| 697-xx | Diskette type error | | |
| 698-xx | Diskette drive speed not within limits | | |
| 699-xx | Diskette drive/media ID error | | <ol style="list-style-type: none"> 1. Replace media. 2. Run the Configuration and Diagnostics Utilities. |
| | | | |
| | | | |

Serial Test Error Codes

| | | |
|---------|-------------------------|--|
| 1101-xx | Serial port test failed | <ol style="list-style-type: none"> 1. Check port configuration 2. Replace the system board and retest. |
|---------|-------------------------|--|

Hard Drive Test Error Codes

| | | |
|---------|---|---|
| 1701-xx | Hard drive format test failed | <ol style="list-style-type: none"> 1. Run the Configuration and Diagnostics Utilities and verify drive type. 2. Verify that all secondary drives have secondary drive capability. 3. Replace the hard drive and retest. 4. Replace the system board and retest. |
| 1702-xx | Hard drive read test failed | |
| 1703-xx | Hard drive write/read/compare test failed | |
| 1704-xx | Hard drive random seek test failed | |
| 1705-xx | Hard drive controller test failed | |
| 1706-xx | Hard drive ready test failed | |
| 1707-xx | Hard drive recalibration test failed | |
| 1708-xx | Hard drive format bad track test failed | |
| 1709-xx | Hard drive reset controller test failed | |
| 1710-xx | Hard drive park head test failed | |
| 1715-xx | Hard drive head select test failed | |
| 1716-xx | Hard drive conditional format test failed | |
| 1717-xx | Hard drive ECC* test failed | |
| 1719-xx | Hard drive power mode test failed | |
| 1724-xx | Network preparation test failed | |
| 1736-xx | Drive monitoring test failed | |

* ECC = Error Correction Code

Video Test Error Codes

| | | |
|--------|--|---|
| 501-xx | Video controller test failed | <p>The following apply to error codes 501-xx through 516-xx:</p> <ol style="list-style-type: none"> 1. Disconnect external monitor and test with internal LCD display. 2. Replace the display assembly and retest. 3. Replace the system board and retest. |
| 502-xx | Video memory test failed | |
| 503-xx | Video attribute test failed | |
| 504-xx | Video character set test failed | |
| 505-xx | Video 80 × 25 mode 9 × 14 character cell test failed | |
| 506-xx | Video 80 × 25 mode 8 × 8 character cell test failed | |
| 507-xx | Video 40 × 25 mode test failed | |
| 508-xx | Video 320 × 200 mode color set 0 test failed | |
| 509-xx | Video 320 × 200 mode color set 1 test failed | |
| 510-xx | Video 640 × 200 mode test failed | |

| | | |
|---------|--|---|
| 511-xx | Video screen memory page test failed | <p>The following steps apply to error codes 2402-xx through 2456-xx:</p> <ol style="list-style-type: none"> 1. Run the Configuration and Diagnostics Utilities. 2. Replace the display assembly and retest. 3. Replace the system board and retest. |
| 512-xx | Video gray scale test failed | |
| 514-xx | Video white screen test failed | |
| 516-xx | Video noise pattern test failed | |
| 2402-xx | Video memory test failed | |
| 2403-xx | Video attribute test failed | |
| 2404-xx | Video character set test failed | |
| 2405-xx | Video 80 × 25 mode 9 × 14 character cell test failed | |
| 2406-xx | Video 80 × 25 mode 8 × 8 character cell test failed | |
| 2408-xx | Video 320 × 200 mode color set 0 test failed | |
| 2409-xx | Video 320 × 200 mode color set 1 test failed | |
| 2410-xx | Video 640 × 200 mode test failed | |
| 2411-xx | Video screen memory page test failed | |
| 2412-xx | Video gray scale test failed | |
| 2414-xx | Video white screen test failed | |
| 2416-xx | Video noise pattern test failed | <ol style="list-style-type: none"> 1. Run the Configuration and Diagnostics Utilities. 2. Disconnect external monitor and test with internal LCD display. 3. Replace the display assembly and retest. 4. Replace the system board and retest. |
| 2418-xx | ECG/VGC memory test failed | |
| 2419-xx | ECG/VGC ROM checksum test failed | |
| 2421-xx | ECG/VGC 640 × 200 graphics mode test failed | |
| 2422-xx | ECG/VGC 640 × 350 16 color set test failed | |
| 2423-xx | ECG/VGC 640 × 350 64 color set test failed | |
| 2424-xx | ECG/VGC monochrome text mode test failed | |

| | | |
|---------|--|---|
| 2425-xx | ECG/VGC monochrome graphics mode test failed | |
| 2431-xx | 640 × 480 graphics test failure | |
| 2432-xx | 320 × 200 graphics (256 color mode) test failure | |
| 2448-xx | Advanced VGA Controller test failed | |
| 2451-xx | 132-column Advanced VGA test failed | |
| 2456-xx | Advanced VGA 256 Color test failed | |
| 2458-xx | Advanced VGA BitBLT test | <p>The following step applies to error codes 2458-xx through 2480-xx:</p> <p>Replace the system board and retest.</p> |
| 2468-xx | Advanced VGA DAC test | |
| 2477-xx | Advanced VGA data path test | |
| 2478-xx | Advanced VGA BitBLT test | |
| 2480-xx | Advanced VGA LineDraw test | |

Audio Test Error Codes

| | | |
|---------|-----------------------------|--------------------------------------|
| 3206-xx | Audio System Internal Error | Replace the system board and retest. |
|---------|-----------------------------|--------------------------------------|

TouchPad/Pointing Device Interface Test Error Codes

| | | |
|---------|-----------------------|--|
| 8601-xx | Mouse test failed | <ol style="list-style-type: none"> 1. Replace the TouchPad and retest. 2. Replace the system board and retest. |
| 8602-xx | Interface test failed | |

CD Drive Test Error Codes

| | | |
|---------|---------------------------|--|
| 3301-xx | CD drive read test failed | <ol style="list-style-type: none"> 1. Replace the CD and retest. 2. Verify that the speakers are connected. 3. Verify that drivers are loaded and properly installed. |
| 3305-xx | CD drive seek test failed | |

| | | |
|---------|-------------------------|--|
| 6600-xx | ID test failed | 4. Replace the CD drive and retest. 5. Replace the system board and retest. |
| 6605-xx | Read test failed | |
| 6608-xx | Controller test failed | |
| 6623-xx | Random read test failed | |

[Back to top](#)

1.800.AT.COMPAQ

[privacy and legal statement](#)

COMPAQ

[STORE](#) | [PRODUCTS](#) | [SERVICES](#) | [SUPPORT](#) | [CONTACT US](#) | [SEARCH](#)

Maintenance & Service Guide

Presario 1600 Series

Models: 1650 and 1655

[Home Page](#) | [Notice](#) | [Preface](#) | [Product Description](#) | [Troubleshooting](#)
[Illustrated Parts Catalog](#) | [Removal & Replacement Procedures](#) | [Specifications](#)
[Pin Assignments](#) | [Battery Pack Operations](#)

Troubleshooting Without Diagnostics

This section provides information about how to identify and correct some common hardware, memory, and software problems. It also explains several types of common messages that may be displayed on the screen. The following pages contain troubleshooting information on:

[Audio](#)[Battery/Battery gauge](#)[CD drive](#)[Diskette/Diskette drive](#)[Display](#)[Hard drive](#)[Hardware Installation](#)[Memory](#)[PC Card](#)[Power](#)[Printer](#)[Touch Pad](#)[Keyboard/Numeric keypad](#)

Since symptoms can appear to be similar, carefully match the symptoms of the computer malfunction against the problem description in the Troubleshooting tables to avoid a misdiagnosis.



WARNING: To avoid a potential shock hazard during troubleshooting procedures, disconnect all power sources before removing the keyboard cover or the display bezel.

Before Replacing Parts

Verify that cables are connected properly to the suspected defective parts.

- Run Computer Setup after connecting external devices.
- Verify that all required device drivers are installed.
- Verify that all required changes have been made to the *CONFIG.SYS* file.
- Verify that all required changes have been made to the *AUTOEXEC.BAT* file.
- Verify that all printer drivers have been installed for each application.

1.800.AT.COMPAQ

[privacy and legal statement](#)

Maintenance & Service Guide
Presario 1600 Series
Models: 1650 and 1655

| [Home Page](#) | [Notice](#) | [Preface](#) | [Product Description](#) | [Troubleshooting](#)
[Illustrated Parts Catalog](#) | [Removal & Replacement Procedures](#) | [Specifications](#)
[Pin Assignments](#) | [Battery Pack Operations](#)

Solving Minor Problems

Some minor problems and possible solutions are outlined in the following tables. If the problem appears related to a software application, check the documentation provided with the software.

Solving Audio Problems

Some common audio problems and solutions are listed in the following table.

| Solving Audio Problems | | |
|---|---|------------------------|
| Problem | Probable Cause | Solution(s) |
| Computer does not beep after the Power-On Self-Test (POST). | This is typical; it indicates successful completion of the Power-On Self-Test (POST). | No action is required. |

Solving Battery Pack and Battery Gauge Problems

Some common causes and solutions for battery pack problems are listed in the following table. The "Solving Power Problems" section in this chapter may also be applicable.

| Solving Battery Pack and Battery Gauge Problems | | |
|---|-----------------------------|--|
| Problem | Probable Cause | Solution(s) |
| Computer won't turn on when battery pack is inserted and power cord is unplugged. | Battery pack is discharged. | Connect the computer to an external power source and charge the battery pack. Replace the battery pack with a fully charged battery pack. |
| | | Check the battery connectors on the system board to verify they are evenly spaced and that they are not bent or broken. |

| | | |
|---|---|--|
| Computer is beeping and battery LED icon is blinking. | Battery charge is low. | Immediately save any open file(s). Then do any one of the following: <ul style="list-style-type: none"> • Connect the computer to an external power source to charge the battery pack. • Turn off the computer or initiate Hibernation until you can find another power source or charge the battery pack. |
| Computer battery LED icon (front on the unit) blinks to indicate low battery condition, but computer does not beep. | Volume is turned down too low. | Adjust the volume. |
| Battery LED icon doesn't light and battery pack won't fast charge. | Battery pack is already charged. | No action is necessary. |
| | Battery pack was exposed to temperature extremes. | Allow time for the battery pack to return to room temperature. |
| | Battery pack is at end of its life. | Replace battery pack. |
| You have to set the date and time every time you turn on the computer. | RTC battery is dead. | Replace the RTC battery. |

| Problem | Probable Cause | Solution(s) |
|---|---|--|
| Battery charge does not last as long as expected. | Battery is being exposed to high temperatures or extremely cold temperatures. | Keep the battery pack within the recommended operating temperature range 50° F to 104° F (10° C to 40° C) or recommended storage range -4° F to 86° F (-20° C to 30° C). Recharge the battery pack. |
| | Battery has partially self-discharged. | Recharge the battery. Discharge the battery completely and then recharge it. |
| | Power management is disabled. | Set a power management level in Computer Setup. |
| | An external device or PC Card is draining the battery. | Turn off or disconnect external devices when not using them. |
| Battery pack is warm to the touch after charging. | Normal warming has occurred due to charging. | No action is required. |
| Battery pack operating time is far less than the documented average operating time. | Power management is turned off or disabled. | Enable power management in Computer Setup and in Windows Power Properties. |
| | An external device or PC Card is draining the battery. | Turn off or disconnect external devices when not using them. |

| | | |
|--|--|---|
| | Battery pack has partially self-discharged. | <p>Condition the battery pack by fully charging, fully discharging, then fully recharging it.</p> <p>To maintain the charge, leave battery packs in the computer when it is connected to external power.</p> <p>If the computer is disconnected from external power for more than two weeks, remove battery packs from the computer to reduce the discharge rate.</p> |
| | Battery pack is being exposed to high temperatures or extremely cold temperatures. | <p>Keep the battery pack within the recommended temperature ranges. Operating: 50° F to 104° F (10° C to 40° C) Storage: -4° F to 86° F (-20° C to 30° C)</p> <p>Recharge the battery pack.</p> |

Solving CD Drive Problems

Some common causes and solutions for CD drive problems are listed in the following table.

| Solving CD Drive Problems | | |
|--------------------------------------|--|--|
| Problem | Probable Cause | Solution(s) |
| CD drive cannot read a compact disc. | Compact disc is upside down or is improperly inserted in the CD drive. | Open the CD loading tray, lay the compact disc in it (label side up), then close the tray. |
| | CD is CD Plus or Pregap/Track 0 type. | Cannot read these type CDs in 24x. Remove the CD. |

Solving Diskette and Diskette Drive Problems

Some common causes and solutions for diskette and diskette drive problems are listed in the following table.

| Solving Diskette and Diskette Drive Problems | | |
|--|---|---|
| Problem | Probable Cause | Solution(s) |
| Diskette drive cannot write to a diskette. | Diskette is write-protected. | Disable the diskette's write-protect feature or use a diskette that is not write-protected. |
| | Computer is writing to the wrong drive. | Check the drive letter in the path statement. |
| | Not enough space is left on the diskette. | Use another diskette. |

| | | |
|--|--|--|
| | Drive error has occurred. | Run Computer Checkup from the Compaq Diagnostics diskette. |
| | Diskette is not formatted. | Format the diskette. At the system prompt, enter FORMAT A: |
| Diskette drive cannot read a diskette. | The wrong type of diskette is being used. | Use the type of diskette required by the drive. |
| | Diskette has a bad sector. | Copy files to hard drive or another diskette. Reformat bad floppy. |
| | Drive error has occurred. | Run Computer Checkup from the Compaq Diagnostics diskette. |
| | Diskette is not formatted. | Format the diskette. At the system prompt, enter FORMAT A: |
| Cannot boot from diskette. | Bootable diskette is not in drive A. | Put the bootable diskette in drive A. |
| | Diskette Boot has incorrect setting in Computer Setup. | Run Computer Setup and set diskette as first to boot. |



Solving Display Problems

This section lists some common causes and solutions for computer display and external monitor problems.

You can perform a monitor self-test on an external VGA color or monochrome monitor by disconnecting the monitor from the computer. To do so, complete the following steps:

1. Turn off the monitor.
2. Turn off the computer.
3. Disconnect the monitor signal cable from the computer.
4. Turn on the monitor and allow it to warm up for one minute.

The display should be white. A narrow black border may also appear on the left and right sides of the display. Either of these displays indicates that the monitor is working properly.

| Solving Display Problems | | |
|--------------------------|---|---|
| Problem | Probable Cause | Solution(s) |
| Screen is dim. | Control for brightness (if applicable) is not set properly. | Adjust the Brightness of the display by using Fn + F7 () or Fn + F8 (). |
| | Computer screen is in direct light. | Tilt display or move computer. |
| Screen is blank. | Screen save was initiated by Power Management due to lack of user activity. | Press any key or touch the Touch Pad. |
| | Display has overheated. | If computer is in direct sunlight, move it and allow it to cool off. |

| | | |
|---|--|---|
| Display is blank and the Suspend icon is flashing. | System is in Suspend mode. | Press any key or touch the Touch Pad. |
| Internal display is blank and the screen on an external monitor displays information. | Display function was switched to the external monitor. | Use Fn + F2 to switch between LCD or CRT . |

| Problem | Probable Cause | Solution(s) |
|--|--|--|
| Internal display flashes or has garbled characters when computer is connected to external monitor. | Using 1024 × 768 or higher resolution on external monitor and have toggled back to internal display, which supports up to 800 × 600. | Restart the computer. |
| The light tubes on the edge of the display panel do not light up at all and Power-On Self-Test (POST) completes when the unit is powered up.** | Improper backlight or display cable connections | Replace the display assembly. |
| | Defective inverter board. | Replace the display assembly. |
| | Defective display cable. | Replace the display assembly. |
| | Defective display panel. | Replace the display assembly. |
| | Defective system board. | Replace the system board. |
| The light tubes on the edge of the display panel do not light up at all and Power-On Self-Test (POST) does not complete when the unit is powered up.** | Defective system board. | Replace the system board. |
| Backlight (brightness) cannot be adjusted with Fn + F7 () or Fn + F8 (-).*** | Improper display cable connections. | 1. Reseat the display cable to the system board. 2. Replace the display assembly. |
| | Defective inverter board. | Replace the display assembly. |
| | Defective display cable. | Replace the display assembly. |
| | Defective system board. | Replace the system board. |
| | Defective inverter board. | Replace the display assembly. |
| | Defective display cable. | Replace the display assembly. |
| | Defective system board. | Replace the system board. |

** This problem indicates that the backlight or its power circuitry has failed. Since you cannot observe the POST result on the display panel when the backlight is not functioning, connect the unit to an external monitor before powering the unit up. If an external monitor is not available, verify that POST completes by opening and closing the display, listening for the single or double beep, and watching for the LEDs turn on at the front of the computer.

| Problem | Probable Cause | Solution(s) |
|---------|----------------|-------------|
|---------|----------------|-------------|

| | | |
|---|---|--|
| <p>This display panel has a continuous pattern across it (e.g., a "jailbars" pattern), has a single color on it, or has garbled graphics across the entire panel. This failure is for patterns across the entire panel (not just on one section).</p> | <p>Improper display cable connections</p> | <p>Reseat the display cable to the following until the problem is solved:</p> <ol style="list-style-type: none"> 1. System board 2. Display assembly |
| | <p>Defective display cable.</p> | <p>Replace the display assembly.</p> |
| | <p>Defective inverter board.</p> | <p>Replace the display assembly.</p> |
| | <p>Defective system board.</p> | <p>Replace the system board.</p> |

NOTE: To perform a "self-test" on an external VGA color monitor, complete the following steps: The screen should be white. A narrow black border may also appear on the left and right sides of the display. Either of these displays indicates that the monitor is working properly.

Solving Hard Drive Problems

Some common causes and solutions for hard drive problems are listed in the following table.

| | |
|--|---|
|  | <p>CAUTION: To prevent loss of information, always maintain an up-to-date backup of your hard drive at all times, in case of errors or failures.</p> |
|--|---|

| Solving Hard Drive Problems | | |
|---|--|---|
| Problem | Probable Cause | Solution(s) |
| <p>Reading hard drive takes an unusually long time after restarting the computer.</p> | <p>System entered Hibernation due to low battery condition and is now exiting from it.</p> | <p>Give the system time to restore the previously saved data to its exact state before Hibernation.</p> |

| | | |
|---------------------------|---|--|
| Hard drive error occurs. | Hard drive has bad sectors or has failed. | Run Computer Checkup. |
| Hard drive does not work. | Hard drive is not seated properly. | Turn off and unplug the computer, remove the battery pack, and remove and then reinstall the hard drive. |

Solving Hardware Installation Problems

Some common causes and solutions for hardware installation problems are listed in the following table.

| Solving Hardware Installation Problems | | |
|--|--|---|
| Problem | Probable Cause | Solutions(s) |
| A new device is not recognized as part of the computer system. | Cable(s) of new external device are loose or power cables are unplugged. | Ensure that all cables are properly and securely connected. |
| | Power switch of new external device is not turned on. | Turn off the computer, turn on the external device, then turn on the computer to integrate the device with the computer system. |
| | Device is not seated properly. | Turn off the computer and reinsert the device. |

Solving Keyboard/Numeric Keypad Problems

Some common causes and solutions for keyboard/numeric keypad problems are listed in the following table.

| Solving Keyboard/Numeric Keypad Problems | | |
|--|---|--|
| Problem | Probable Cause | Solution(s) |
| Embedded numeric keypad on computer keyboard is disabled. | Num Lock function is not enabled. | Press the Shift+NumLk keys to enable the Num Lock function and embedded numeric keypad. The Num Lock icon on the status panel turns on. |
| Embedded numeric keypad is disabled and Num Lock function is on. | External numeric keypad is connected to the computer. | Disconnect the external numeric keypad from the computer. |

Solving Memory Problems

Some common causes and solutions for memory problems are listed in the following table.

| Solving Memory Problems | | |
|-------------------------|----------------|-------------|
| Problem | Probable Cause | Solution(s) |
| | | |

| | | |
|--|--|--|
| Memory count during Power-On Self-Test (POST) is incorrect. | Optional memory expansion card is installed incorrectly, is incompatible with the computer, or is defective. | Ensure that the optional memory expansion card is installed correctly. |
| "Out of Memory" message is displayed on the screen or insufficient memory error occurs during operation. | System ran out of memory for the application. | Check the application documentation for memory requirements. Install additional memory. |
| | Too many TSR (terminate-and stay-resident) applications are running. | Remove from memory any TSR applications that you do not need. |

[Solving Minor Problems \(continued\)](#)

1.800.AT.COMPAQ

[privacy and legal statement](#)

COMPAQ

[STORE](#) | [PRODUCTS](#) | [SERVICES](#) | [SUPPORT](#) | [CONTACT US](#) | [SEARCH](#)

Maintenance & Service Guide

Presario 1600 Series

Models: 1650 and 1655

| [Home Page](#) | [Notice](#) | [Preface](#) | [Product Description](#) | [Troubleshooting](#)
[Illustrated Parts Catalog](#) | [Removal & Replacement Procedures](#) | [Specifications](#)
[Pin Assignments](#) | [Battery Pack Operations](#)

Contacting Compaq Support

Obtain the following information before contacting Compaq Reseller Support:

- Product name
- Product serial number
- Purchase date
- Conditions under which the problem occurred
- Any error messages that have occurred
- Hardware configuration
- Type of printer connected
- Hardware/software being used
- Printed result of Computer Checkup (TEST)
- Printed copies of *CONFIG.SYS* and *AUTOEXEC.BAT* files, if possible

Shipping Preparation

To ship the computer, complete the following steps:

1. Back up the critical hard drive files. Ensure that backup tapes/diskette are not exposed to electrical or magnetic fields while stored in transit.
2. Turn off the computer and external devices.
3. Disconnect the external devices from their power sources, then from the computer.

IMPORTANT:

Ensure that there is no diskette in the diskette drive and that there are no PC Cards in the PC slots.

4. Close the display and all exterior doors of the computer.
5. Pack the computer with sufficient packing material to protect it. Use the original packing box or similar packaging.

1.800.A.T.COMPAQ

[privacy and legal statement](#)

Maintenance & Service Guide

Presario 1600 Series

Models: 1650 and 1655

| [Home Page](#) | [Notice](#) | [Preface](#) | [Product Description](#) | [Troubleshooting](#)
[Illustrated Parts Catalog](#) | [Removal & Replacement Procedures](#) | [Specifications](#)
[Pin Assignments](#) | [Battery Pack Operations](#)

System Unit

System Unit

[Boards](#)

[Display Assembly](#)

[Mass Storage Devices](#)

[Miscellaneous Cable Kit](#)

[Cables](#)

[Miscellaneous Hardware and Plastics Kit](#)

[Miscellaneous Parts](#)

[Documentation and Software](#)

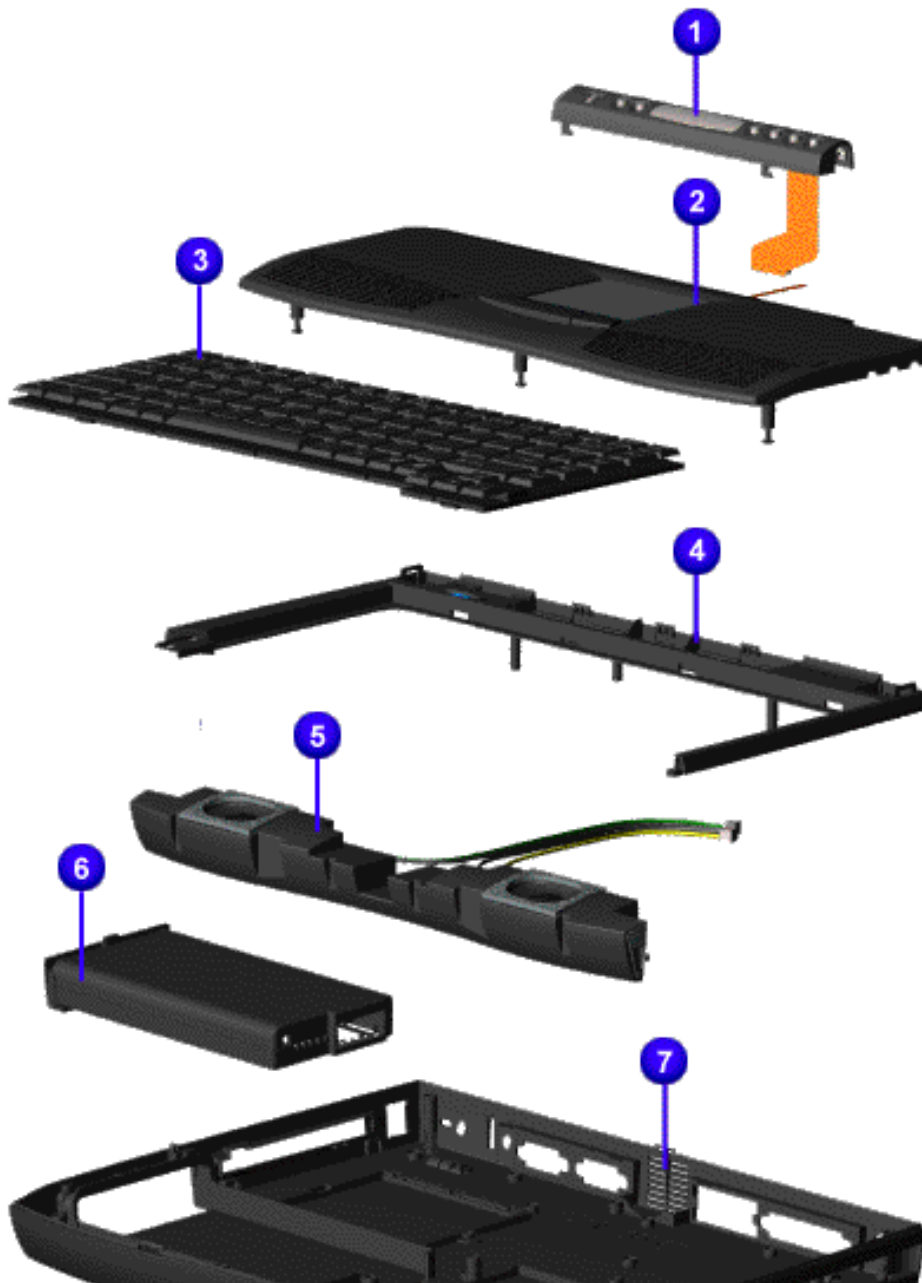

| Description | Spare Part Number |
|---|-------------------|
| 1. Status Panel | 293737-001 |
| 2. Palmrest Cover | 332226-001 |
| 3. Keyboard | |
| United States | 330981-001 |
| Canada | 330981-401 |
| 4. Upper CPU Cover with Power Switch Connector (Top Plastics) | 293739-001 |
| 5. Speaker Assembly w/ Cable | 293883-001 |
| 6. Battery Pack, Li Ion | 330936-001 |
| 7. CPU Base Assembly Enclosure, (Bottom Plastics) | 331156-001 |



1.800.AT.COMPAQ

[privacy and legal statement](#)

Maintenance & Service Guide Presario 1600 Series Models: 1650 and 1655

| [Home Page](#) | [Notice](#) | [Preface](#) | [Product Description](#) | [Troubleshooting](#)
[Illustrated Parts Catalog](#) | [Removal & Replacement Procedures](#) | [Specifications](#)
[Pin Assignments](#) | [Battery Pack Operations](#)

Boards

| |
|---|
| System Unit |
| Boards |
| Display Assembly |
| Mass Storage Devices |
| Miscellaneous Cable Kit |
| Cables |
| Miscellaneous Hardware and Plastics Kit |
| Miscellaneous Parts |
| Documentation and Software |

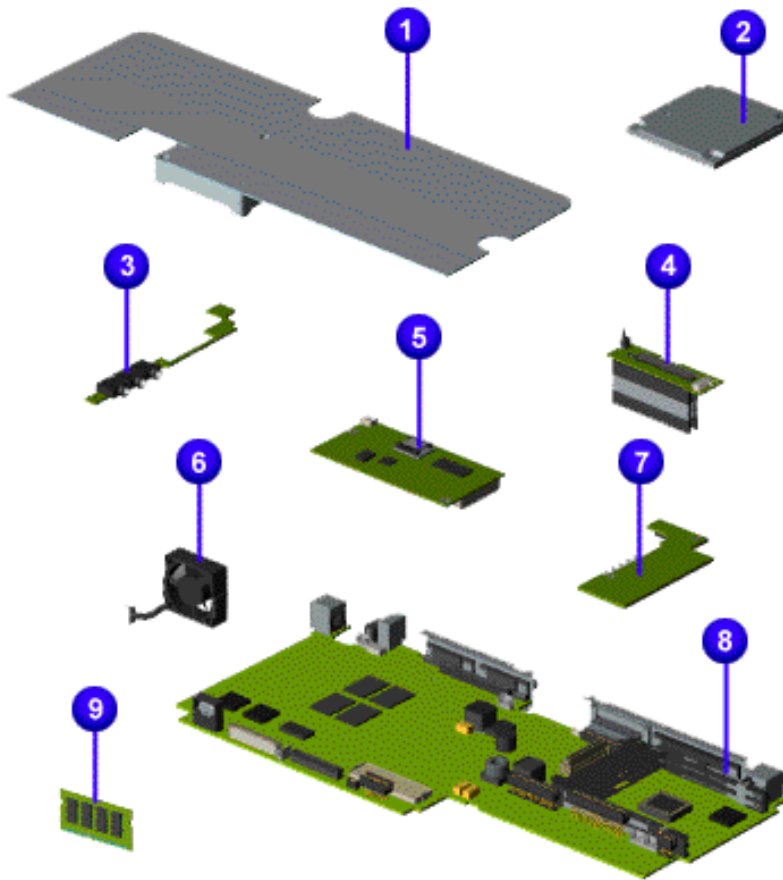

| Description | Spare Part Number |
|--|-------------------|
| 1. Heatspreader | 331164-001 |
| 2. Processor Pentium II/233 | 347556-001 |
| Processor Pentium II/266 | 330983-001 |
| 3. Audio Board | 331010-001 |
| 4. LCD Interface Board TFT w/ header | 293156-001 |
| 5. Modem, M+- 56.0 Kbps Data/Fax 138610-001 | |
| Modem, K-56.0 Kbps Data/Fax 138657-001 | |
| 6. Fan w/ Cable | 332228-001 |
| 7. Voltage Converter | 331019-001 |

| | |
|---|--|
| 8. System Board, w/o processor | 331009-001 |
| 9. Memory Module 16-MB 32-MB 64-MB | 293726-001 293727-001 332208-001 |

1.800.AT.COMPAQ

[privacy and legal statement](#)

COMPAQ

[STORE](#) | [PRODUCTS](#) | [SERVICES](#) | [SUPPORT](#) | [CONTACT US](#) | [SEARCH](#)

Maintenance & Service Guide Presario 1600 Series Models: 1650 and 1655

[Home Page](#) | [Notice](#) | [Preface](#) | [Product Description](#) | [Troubleshooting](#)
[Illustrated Parts Catalog](#) | [Removal & Replacement Procedures](#) | [Specifications](#)
[Pin Assignments](#) | [Battery Pack Operations](#)

System Unit

[Boards](#)

[Display Assembly](#)

[Mass Storage Devices](#)

[Miscellaneous Cable Kit](#)

[Cables](#)

[Miscellaneous Hardware and Plastics Kit](#)

[Miscellaneous Parts](#)

[Documentation and Software](#)



| Description | Spare Part Number |
|--|-------------------|
| Display Assembly w/ Cable, 12.1 inch TFT | 331014-001 |
| Display Assembly w/ Cable, 13.3 inch TFT | 331012-001 |

1.800.AT.COMPAQ

[privacy and legal statement](#)

COMPAQ

[STORE](#) | [PRODUCTS](#) | [SERVICES](#) | [SUPPORT](#) | [CONTACT US](#) | [SEARCH](#)

Maintenance & Service Guide Presario 1600 Series Models: 1650 and 1655

| [Home Page](#) | [Notice](#) | [Preface](#) | [Product Description](#) | [Troubleshooting](#)
[Illustrated Parts Catalog](#) | [Removal & Replacement Procedures](#) | [Specifications](#)
[Pin Assignments](#) | [Battery Pack Operations](#)

Mass Storage Devices

| |
|---|
| System Unit |
| Boards |
| Display Assembly |
| Mass Storage Devices |
| Miscellaneous Cable Kit |
| Cables |
| Miscellaneous Hardware and Plastics Kit |
| Miscellaneous Parts |
| Documentation and Software |

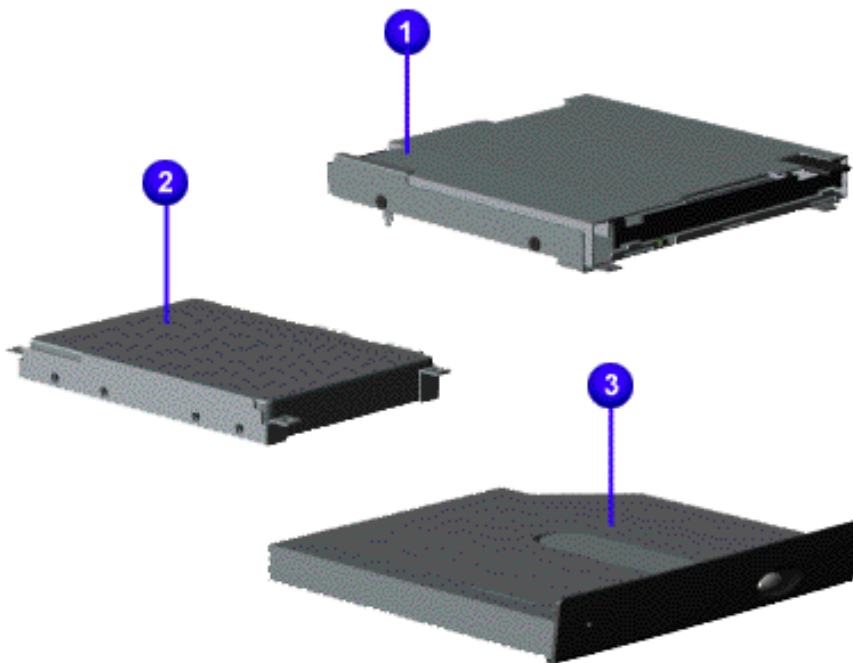

| Description | Spare Part Number |
|---|-------------------|
| 1. Diskette Drive w/ Cable, 1.44 MB, 3.5 inch | 331165-001 |
| 2. Hard Drive w/ Mounting Bracket, 5.0-GB | 331011-001 |
| Hard Drive w/Mounting Bracket 4.0-GB | 330969-001 |
| 3. 24x MAX CD Drive | 330967-001 |

1.800.AT.COMPAQ

[privacy and legal statement](#)

Maintenance & Service Guide

Presario 1600 Series

Models: 1650 and 1655

[Home Page](#) | [Notice](#) | [Preface](#) | [Product Description](#) | [Troubleshooting](#)
[Illustrated Parts Catalog](#) | [Removal & Replacement Procedures](#) | [Specifications](#)
[Pin Assignments](#) | [Battery Pack Operations](#)

Miscellaneous Cables Kit

| |
|---|
| System Unit |
| Boards |
| Display Assembly |
| Mass Storage Devices |
| Miscellaneous Cable Kit |
| Cables |
| Miscellaneous Hardware and Plastics Kit |
| Miscellaneous Parts |
| Documentation and Software |

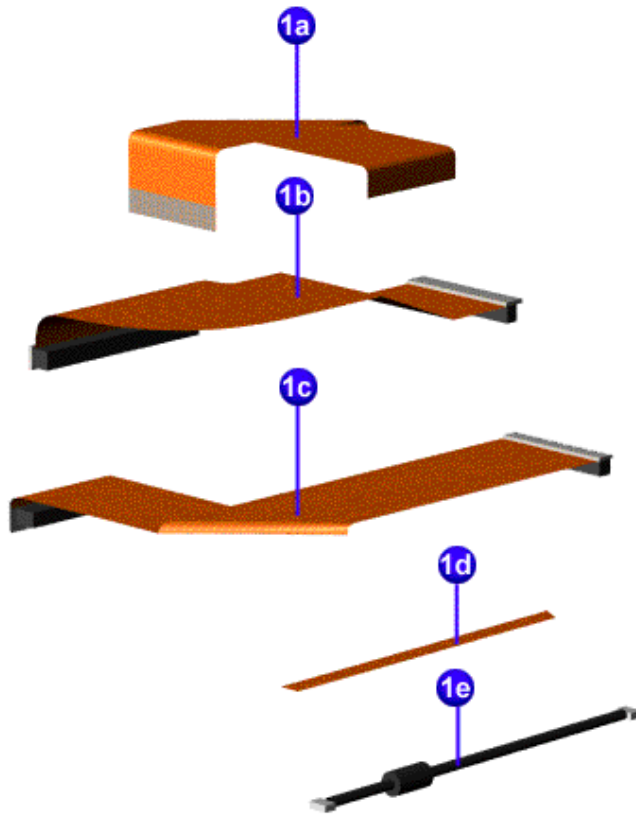

Miscellaneous Cables Kit
Spare Part Number: 332234-001

| Description | Quantity |
|------------------------------|----------|
| 1a. Cable, Diskette Drive | 1 |
| 1b. Cable, Hard Drive | 1 |
| 1c. Cable, CD Drive | 1 |
| 1d. Cable, TouchPad SW Board | 1 |
| 1e. Cable, Fax/Modem | 1 |

COMPAQ | [STORE](#) | [PRODUCTS](#) | [SERVICES](#) | [SUPPORT](#) | [CONTACT US](#) | [SEARCH](#)

Maintenance & Service Guide

Presario 1600 Series

Models: 1650 and 1655

| [Home Page](#) | [Notice](#) | [Preface](#) | [Product Description](#) | [Troubleshooting](#)
[Illustrated Parts Catalog](#) | [Removal & Replacement Procedures](#) | [Specifications](#)
[Pin Assignments](#) | [Battery Pack Operations](#)

| |
|---|
| System Unit |
| Boards |
| Display Assembly |
| Mass Storage Devices |
| Miscellaneous Cable Kit |
| Cables |
| Miscellaneous Hardware and Plastics Kit |
| Miscellaneous Parts |
| Documentation and Software |

| Power Cords | |
|-------------|-------------------|
| Description | Spare Part Number |
| Power Cord | |

| Modem Cables | |
|--------------|-------------------|
| Description | Spare Part Number |
| 1. Modem | |

1.800.AT.COMPAQ

[privacy and legal statement](#)

Maintenance & Service Guide

Presario 1600 Series

Models: 1650 and 1655

[Home Page](#) | [Notice](#) | [Preface](#) | [Product Description](#) | [Troubleshooting](#)
[Illustrated Parts Catalog](#) | [Removal & Replacement Procedures](#) | [Specifications](#)
[Pin Assignments](#) | [Battery Pack Operations](#)

Miscellaneous Hardware and Plastics Kit

| |
|---|
| System Unit |
| Boards |
| Display Assembly |
| Mass Storage Devices |
| Miscellaneous Cable Kit |
| Cables |
| Miscellaneous Hardware and Plastics Kit |
| Miscellaneous Parts |
| Documentation and Software |

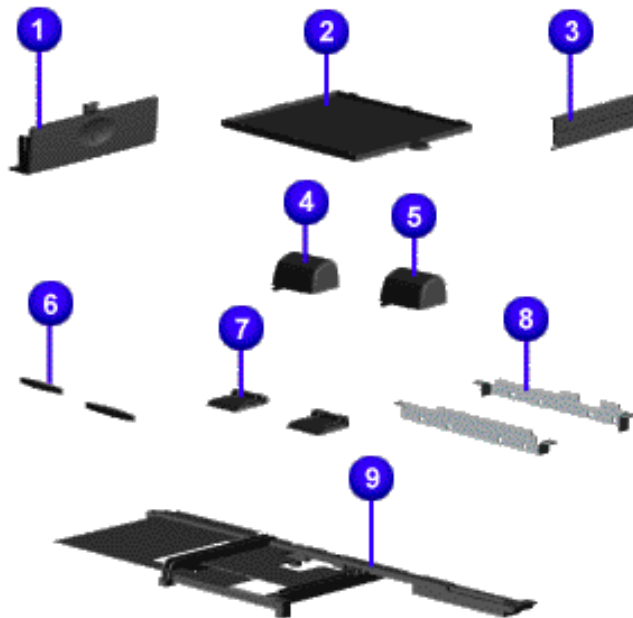

| <i>Miscellaneous Hardware and Plastics Kit</i> <i>Spare Part Number: 293761-001</i> | |
|--|----------|
| Description | Quantity |
| 1. Door, Battery Pack | 1 each |
| 2. Cover, Memory Module | 1 each |
| 3. Door, PCMCIA | 2 each |
| 4. Hinge (Clutch) Cover, Left | 1 each |
| 5. Hinge (Clutch) Cover, Right | 1 each |
| 6. Rubber Foot | 10 each |
| 7. Stand Foot (plastic) | 10 each |
| 8. Hard Drive Mounting Bracket | 1 each |
| 9. Stiffener Bracket | 1 each |

1.800.AT.COMPAQ

[privacy and legal statement](#)

Maintenance & Service Guide

Presario 1600 Series

Models: 1650 and 1655

| [Home Page](#) | [Notice](#) | [Preface](#) | [Product Description](#) | [Troubleshooting](#)
[Illustrated Parts Catalog](#) | [Removal & Replacement Procedures](#) | [Specifications](#)
[Pin Assignments](#) | [Battery Pack Operations](#)

Miscellaneous Parts

[System Unit](#)

[Boards](#)

[Display Assembly](#)

[Mass Storage Devices](#)

[Miscellaneous Cable Kit](#)

[Cables](#)

[Miscellaneous Hardware and Plastics Kit](#)

[Miscellaneous Parts](#)

[Documentation and Software](#)

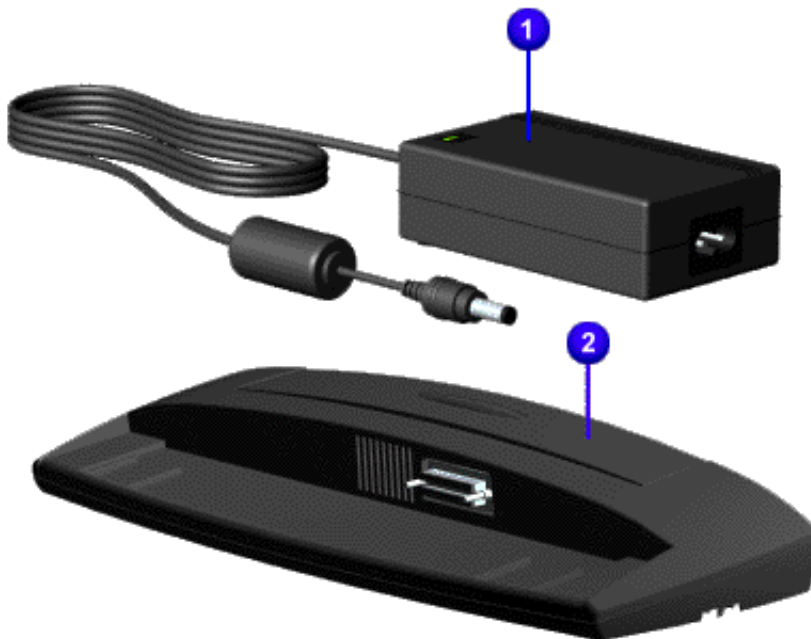

| Description | Spare Part Number |
|-------------------------------------|-------------------|
| 1. AC Adapter | 298239-001 |
| 2. Port Replicator | 293857-001 |
| Clock Battery (Not Shown) | 117099-001 |
| Miscellaneous Screw Kit (Not Shown) | 293760-001 |
| Logo Kit (Not Shown) | 203727-001 |
| Return Kit (Not Shown) | 293799-001 |

1.800.AT.COMPAQ

[privacy and legal statement](#)

Maintenance & Service Guide

Presario 1600 Series

Models: 1650 and 1655

[Home Page](#) | [Notice](#) | [Preface](#) | [Product Description](#) | [Troubleshooting](#)
[Illustrated Parts Catalog](#) | [Removal & Replacement Procedures](#) | [Specifications](#)
[Pin Assignments](#) | [Battery Pack Operations](#)

Documentation and Software

| System Unit | Description | Spare Part Number | | | | | | | | | | | | | | | | | | | | | | | | | | | | | | | | |
|---|---|--------------------------|------------------------------|--|--|--|--------|-------|--------|-------|------|---------|------|------|------|----------|------|--------|------|-------|------|-----------|------|-------|------|---------|------|-----|------|----------|------|------|------|----------|
| Boards | Quick Restore CD | | | | | | | | | | | | | | | | | | | | | | | | | | | | | | | | | |
| Display Assembly | Not Available | | | | | | | | | | | | | | | | | | | | | | | | | | | | | | | | | |
| Mass Storage Devices | Not Available | | | | | | | | | | | | | | | | | | | | | | | | | | | | | | | | | |
| Miscellaneous Cable Kit | Not Available | | | | | | | | | | | | | | | | | | | | | | | | | | | | | | | | | |
| Cables | Not Available | | | | | | | | | | | | | | | | | | | | | | | | | | | | | | | | | |
| Miscellaneous Hardware and Plastics Kit | Quick Reference Guide | | | | | | | | | | | | | | | | | | | | | | | | | | | | | | | | | |
| Miscellaneous Parts | QuickFind for Windows, North America, Latin America, Asia Pacific | | | | | | | | | | | | | | | | | | | | | | | | | | | | | | | | | |
| Documentation and Software | QuickFind for Windows, Europe, Middle East, Africa | | | | | | | | | | | | | | | | | | | | | | | | | | | | | | | | | |
| <p>*QuickFind is updated monthly. To complete the QuickFind part number, add the suffix from the table below for the desired month. If you do not specify the 3-digit suffix, the default is the current month in which the order is placed.</p> <table border="1" style="width: 100%; text-align: center;"> <thead> <tr> <th colspan="4">QuickFind Part Number Suffix</th> </tr> <tr> <th>Suffix</th> <th>Month</th> <th>Suffix</th> <th>Month</th> </tr> </thead> <tbody> <tr> <td>-001</td> <td>January</td> <td>-007</td> <td>July</td> </tr> <tr> <td>-002</td> <td>February</td> <td>-008</td> <td>August</td> </tr> <tr> <td>-003</td> <td>March</td> <td>-009</td> <td>September</td> </tr> <tr> <td>-004</td> <td>April</td> <td>-010</td> <td>October</td> </tr> <tr> <td>-005</td> <td>May</td> <td>-011</td> <td>November</td> </tr> <tr> <td>-006</td> <td>June</td> <td>-012</td> <td>December</td> </tr> </tbody> </table> | | | QuickFind Part Number Suffix | | | | Suffix | Month | Suffix | Month | -001 | January | -007 | July | -002 | February | -008 | August | -003 | March | -009 | September | -004 | April | -010 | October | -005 | May | -011 | November | -006 | June | -012 | December |
| QuickFind Part Number Suffix | | | | | | | | | | | | | | | | | | | | | | | | | | | | | | | | | | |
| Suffix | Month | Suffix | Month | | | | | | | | | | | | | | | | | | | | | | | | | | | | | | | |
| -001 | January | -007 | July | | | | | | | | | | | | | | | | | | | | | | | | | | | | | | | |
| -002 | February | -008 | August | | | | | | | | | | | | | | | | | | | | | | | | | | | | | | | |
| -003 | March | -009 | September | | | | | | | | | | | | | | | | | | | | | | | | | | | | | | | |
| -004 | April | -010 | October | | | | | | | | | | | | | | | | | | | | | | | | | | | | | | | |
| -005 | May | -011 | November | | | | | | | | | | | | | | | | | | | | | | | | | | | | | | | |
| -006 | June | -012 | December | | | | | | | | | | | | | | | | | | | | | | | | | | | | | | | |

1.800.AT.COMPAQ

[privacy and legal statement](#)

Maintenance & Service Guide

Presario 1600 Series

Models: 1650 and 1655

[Home Page](#) | [Notice](#) | [Preface](#) | [Product Description](#) | [Troubleshooting](#)
[Illustrated Parts Catalog](#) | [Removal & Replacement Procedures](#) | [Specifications](#)
[Pin Assignments](#) | [Battery Pack Operations](#)

Electrostatic Discharge

A sudden discharge of static electricity from a finger or other conductor can destroy static-sensitive devices or microcircuitry. Often the spark is neither felt nor heard, but damage occurs. An electronic device exposed to electrostatic discharge (ESD) may not be affected at all and will work perfectly throughout a normal cycle. Although, it may function normally for a while, then degrade in the internal layers, reducing its life expectancy.

Networks built into many integrated circuits provide some protection, but in many cases, the discharge contains enough power to alter device parameters or melt silicon junctions.

Generating Static

The table shows how different activities generate static electricity and at different electrostatic voltage levels.

Typical Electrostatic Voltages

| Event | Relative Humidity | | |
|----------------------------------|-------------------|----------|---------|
| | 10% | 40% | 55% |
| Walking across carpet | 35,000 V | 15,000 V | 7,500 V |
| Walking across vinyl floor | 12,000 V | 5,000 V | 3,000 V |
| Motions of bench worker | 6,000 V | 800 V | 400 V |
| Removing DIPS from plastic tubes | 2,000 V | 700 V | 400 V |

| | | | |
|---|----------|----------|---------|
| Removing DIPS from vinyl trays | 11,500 V | 4,000 V | 2,000 V |
| Removing DIPS from Styrofoam | 14,500 V | 5,000 V | 3,500 V |
| Removing bubble pack from PCBs | 26,000 V | 20,000 V | 7,000 V |
| Packing PCBs in foam-lined box | 21,000 V | 11,000 V | 5,000 V |
| NOTE: 700 volts can degrade a product. | | | |

[Return to Removal & Replacement Procedures](#)

1.800.AT.COMPAQ

[privacy and legal statement](#)

COMPAQ

[STORE](#) | [PRODUCTS](#) | [SERVICES](#) | [SUPPORT](#) | [CONTACT US](#) | [SEARCH](#)

Maintenance & Service Guide

Presario 1600 Series

Models: 1650 and 1655

[Home Page](#) | [Notice](#) | [Preface](#) | [Product Description](#) | [Troubleshooting](#)
[Illustrated Parts Catalog](#) | [Removal & Replacement Procedures](#) | [Specifications](#)
[Pin Assignments](#) | [Battery Pack Operations](#)

Service Considerations

Listed below are some of the considerations that you should keep in mind during the disassembly and assembly of the computer.

Tool and Software Requirements

To service the computer, you need the following:

- Compaq screwdriver kit (Spare Part No. 161946-001)
- Torx T-9 screwdriver
- 5mm nut drivers (for screwlocks and standoffs)
- Small, standard screwdriver
- Small, Phillips screwdriver
- Plastic shroud
- Diagnostics software

Screws

The screws used in the computer are not interchangeable. If an incorrect screw is used during the reassembly process, it can damage the unit. Compaq strongly recommends that all screws removed during disassembly be kept with the part that was removed, then returned to their proper locations.

IMPORTANT: As each subassembly is removed from the computer, it should be placed away from the work area to prevent damage.

Return to Removal & Replacement Procedures

1.800.AT.COMPAQ

[privacy and legal statement](#)

Maintenance & Service Guide

Presario 1600 Series

Models: 1650 and 1655

| [Home Page](#) | [Notice](#) | [Preface](#) | [Product Description](#) | [Troubleshooting](#)
[Illustrated Parts Catalog](#) | [Removal & Replacement Procedures](#) | [Specifications](#)
[Pin Assignments](#) | [Battery Pack Operations](#)

Cables and Connectors

Most cables used throughout the unit are ribbon cables. Cables must be handled with extreme care to avoid damage. Apply only the tension required to seat or unseat the cables during insertion or removal from the connector. Handle cables by the connector whenever possible. In all cases, avoid bending, twisting, or tearing the cables, and ensure that the cables are routed in such a way that they cannot be caught or snagged by parts being removed or replaced.

Cables

Use the following precautions when handling cables to avoid damage to the cable or computer:

- Always handle cables by their connectors.
- Avoid bending, twisting, or pulling on the cables.
- Apply minimum required force when seating or unseating the cables from their connectors.
- Place the cables in such a manner that they cannot be caught or snagged by parts being removed or replaced.
- Handle flex cables with extreme care; they can tear easily.



CAUTION: When serving these computers, ensure that cables are placed in their proper location during the reassembly process. Improper cable placement can cause severe damage to the unit.

Select the desired illustration.

Removing a Cable from a [ZIF Connector](#).

The ribbon cable position for the [5.0-GB or 4.0 hard drive](#).

The ribbon cable position for the [CD drive](#).

The ribbon cable position for the [diskette drive](#).

The cable position for the [speaker assembly](#).

Plastic Parts

Plastic parts can be damaged by the use of excessive force during disassembly and reassembly. When handling the plastic parts, use care. Apply pressure only at the points designated in the maintenance instructions.

[Back to Top of Page](#)

[Return to Removal & Replacement Procedures](#)

| | | | | | |
|-----------------------------|------------------------|--------------------------|-------------------------|---------------------------|----------------------------|
| Compaq Home | Search | Products | Service | Worldwide | Compaq.com |
|-----------------------------|------------------------|--------------------------|-------------------------|---------------------------|----------------------------|

[Comments?](#)

[Legal Notices and Privacy Statement](#)

Revised: dd Month 1998

[1.800.AT.COMPAQ](#)

[privacy and legal statement](#)

[COMPAQ](#)[STORE](#) | [PRODUCTS](#) | [SERVICES](#) | [SUPPORT](#) | [CONTACT US](#) | [SEARCH](#)

Maintenance & Service Guide

Presario 1600 Series

Models: 1650 and 1655

[Home Page](#) | [Notice](#) | [Preface](#) | [Product Description](#) | [Troubleshooting](#)
[Illustrated Parts Catalog](#) | [Removal & Replacement Procedures](#) | [Specifications](#)
[Pin Assignments](#) | [Battery Pack Operations](#)

Preparing the Computer for Disassembly

[Electrostatic Discharge](#)

Before beginning removal and replacement procedures, complete the following procedures:

[Service Considerations](#)

1. Disconnect AC power and any external devices.

[Cables and Connectors](#)

2. Remove the battery pack.

[Preparing the Computer for Disassembly](#)

3. Remove any PC Cards.

IMPORTANT:

The battery pack should be removed before performing any internal maintenance on the computer.

[Battery Pack](#)

[Palmrest Cover with Touch Pad](#)

[Keyboard](#)

[Heatspreader](#)

[Modem](#)

[Processor](#)

[Status Panel](#)

[Interface Board](#)



WARNING: Metal objects can damage the battery pack as well as the battery contacts in the battery compartment. To prevent damage, do not allow metal objects to touch the battery contacts. Place only the battery pack for the Compaq Presario 1600 Series Portable Computers into the battery compartment. Do not force the battery pack into the bay if insertion does not occur easily.

[Hard Drives](#)

[Battery
Charger Board](#)

[CD Drive](#)

[Display Panel
Assembly](#)

[Upper CPU
Cover](#)

[Speaker
Assembly](#)

[Diskette Drive](#)

[Fan Assembly](#)

[Audio Board](#)

[System Board](#)

[Memory
Module](#)



CAUTION: Do not crush, puncture, or incinerate the battery pack. Do not open a battery pack, as this damages the pack, makes it unusable, and exposes potentially harmful battery components. There are no field-serviceable parts located inside the battery pack.

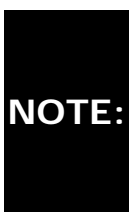

The Compaq Presario 1600 Series Portable Computers have several screws of various sizes which are **not** interchangeable. **NOTE:** Care must be taken during reassembly to ensure that the correct screws are used in their correct location. During removal please keep respective screws with their associate sub-assembly.

1.800.AT.COMPAQ

[privacy and legal statement](#)

Maintenance & Service Guide

Presario 1600 Series

Models: 1650 and 1655

[Home Page](#) | [Notice](#) | [Preface](#) | [Product Description](#) | [Troubleshooting](#)
[Illustrated Parts Catalog](#) | [Removal & Replacement Procedures](#) | [Specifications](#)
[Pin Assignments](#) | [Battery Pack Operations](#)

Removing the Battery Pack

[Electrostatic Discharge](#)

[Service Considerations](#)

[Cables and Connectors](#)

[Preparing the Computer for Disassembly](#)

[Battery Pack](#)

[Palmrest Cover with Touch Pad](#)

[Keyboard](#)

[Heatspreader](#)

[Modem](#)

[Processor](#)

[Status Panel](#)

[Interface Board](#)

[Hard Drives](#)

[Battery Charger Board](#)

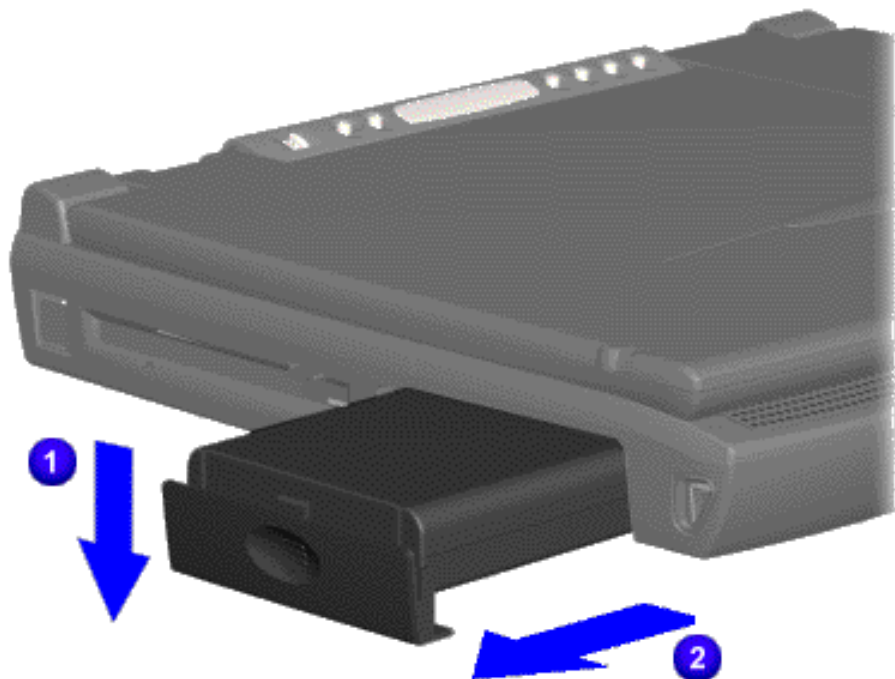

To remove the battery pack, complete the following steps:

1. Slide the battery pack compartment **1** door down and **2** pull the battery pack forward from the chassis.

To replace the battery pack, reverse the procedure.

NOTE: The replacement battery pack will come with a removable door. To properly replace the battery pack follow the instructions below.

[CD Drive](#)

[Display Panel
Assembly](#)

[Upper CPU
Cover](#)

[Speaker
Assembly](#)

[Diskette Drive](#)

[Fan Assembly](#)

[Audio Board](#)

[System Board](#)

[Memory
Module](#)

To replace a new battery pack, complete the following steps:

1. Push forward on the battery pack with tab to insert the battery pack into the battery pack slot.
2. Slide the battery pack door up onto the opening for the battery pack door.

1.800.AT.COMPAQ

[privacy and legal statement](#)

Maintenance & Service Guide

Presario 1600 Series

Models: 1650 and 1655

| [Home Page](#) | [Notice](#) | [Preface](#) | [Product Description](#) | [Troubleshooting](#)
[Illustrated Parts Catalog](#) | [Removal & Replacement Procedures](#) | [Specifications](#)
[Pin Assignments](#) | [Battery Pack Operations](#)

Removing the Palmrest Cover with Touch Pad

[Electrostatic Discharge](#)

[Service Considerations](#)

[Cables and Connectors](#)

[Preparing the Computer for Disassembly](#)

[Battery Pack](#)

[Palmrest Cover with Touch Pad](#)

[Keyboard](#)

[Heatspreader](#)

[Modem](#)

[Processor](#)

[Status Panel](#)

[Interface Board](#)

[Hard Drives](#)

[Battery Charger Board](#)

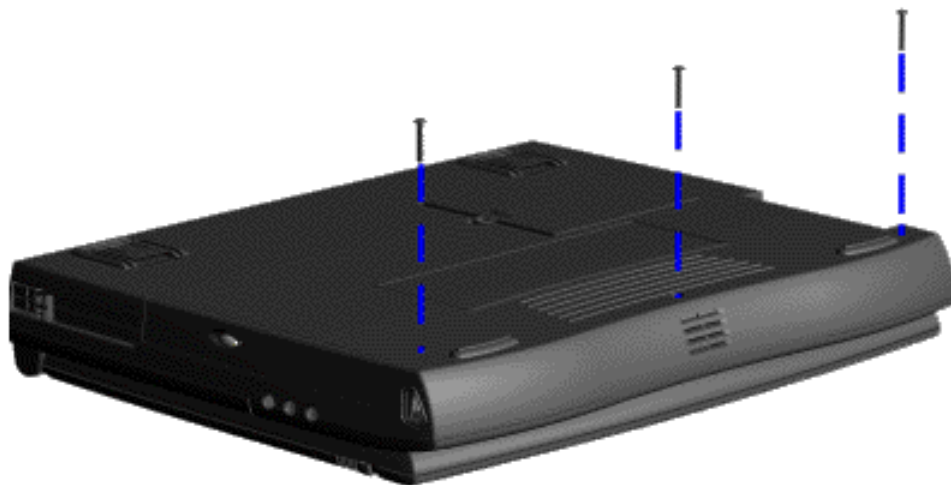

The palmrest cover with touch pad must be removed to gain access to any of the interior components of the computer, and it is the first component that has to be removed to gain access to the interior components.

NOTE: It is not necessary to remove the display panel assembly to access the interior components of the computer.

To remove the palmrest cover with touch pad, complete the following steps:

1. [Prepare the computer for disassembly.](#)

[CD Drive](#)

[Display Panel
Assembly](#)

[Upper CPU
Cover](#)

[Speaker
Assembly](#)

[Diskette Drive](#)

[Fan Assembly](#)

[Audio Board](#)

[System Board](#)

[Memory
Module](#)

2. Close the computer and turn the computer upside down.

3. Remove three screws from the bottom of the computer.

[Next Step](#)

1.800.AT.COMPAQ

[privacy and legal statement](#)

Maintenance & Service Guide

Presario 1600 Series
Models: 1650 and 1655

[Home Page](#) | [Notice](#) | [Preface](#) | [Product Description](#) | [Troubleshooting](#)
[Illustrated Parts Catalog](#) | [Removal & Replacement Procedures](#) | [Specifications](#)
[Pin Assignments](#) | [Battery Pack Operations](#)

Removing the Keyboard

[Electrostatic Discharge](#)

[Service Considerations](#)

[Cables and Connectors](#)

[Preparing the Computer for Disassembly](#)

[Battery Pack](#)

[Palmrest Cover with Touch Pad](#)

[Keyboard](#)

[Heatspreader](#)

[Modem](#)

[Processor](#)

[Status Panel](#)

[Interface Board](#)

[Hard Drives](#)

[Battery Charger Board](#)

[CD Drive](#)

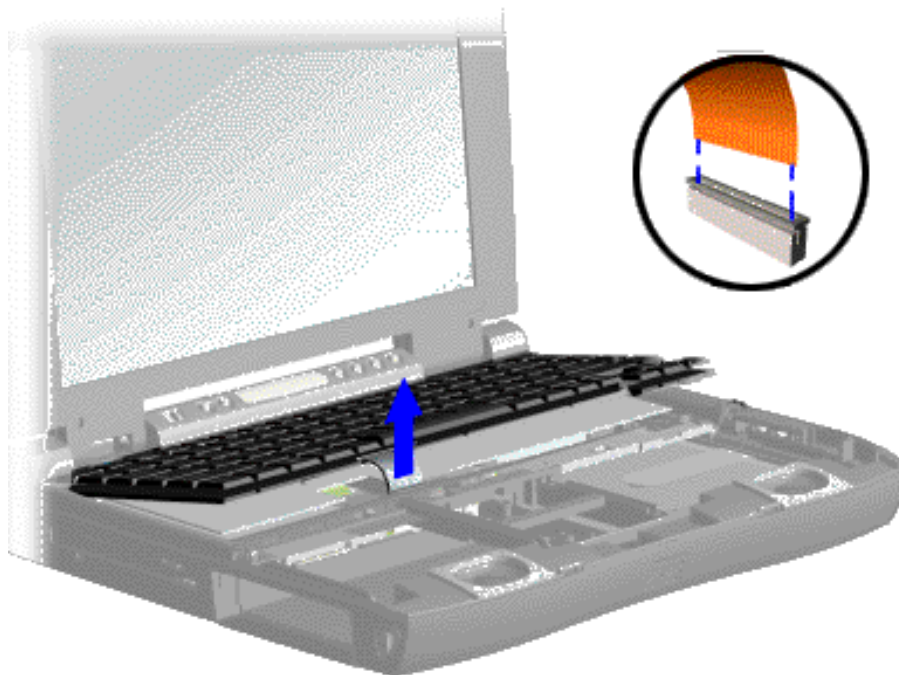

To remove the keyboard, complete the following steps:

1. [Prepare the computer for disassembly.](#)
2. [Remove the palmrest cover with touch pad.](#)
3. Gently lift up the front of the keyboard and disconnect the flex cable from the ZIF connector on the system board.

[Display Panel Assembly](#)

[Upper CPU Cover](#)

[Speaker Assembly](#)

[Diskette Drive](#)

[Fan Assembly](#)

[Audio Board](#)

[System Board](#)

[Memory Module](#)

[Memory Module](#)

[Memory Module](#)

[Memory Module](#)

[Memory Module](#)

[Memory Module](#)

[Memory Module](#)

NOTE:

To remove a cable from a ZIF connector, lift both corners of the ZIF connector and slide simultaneously with constant light force. Then remove the cable. Refer to the section on [Cables and Connectors](#) for more information on removing a cable from the ZIF connector.

[Next Step](#)

1.800.AT.COMPAQ

[privacy and legal statement](#)

COMPAQ

[STORE](#) | [PRODUCTS](#) | [SERVICES](#) | [SUPPORT](#) | [CONTACT US](#) | [SEARCH](#)

Maintenance & Service Guide

Presario 1600 Series

Models: 1650 and 1655

[Home Page](#) | [Notice](#) | [Preface](#) | [Product Description](#) | [Troubleshooting](#)
[Illustrated Parts Catalog](#) | [Removal & Replacement Procedures](#) | [Specifications](#)
[Pin Assignments](#) | [Battery Pack Operations](#)

Removing the Heatspreader

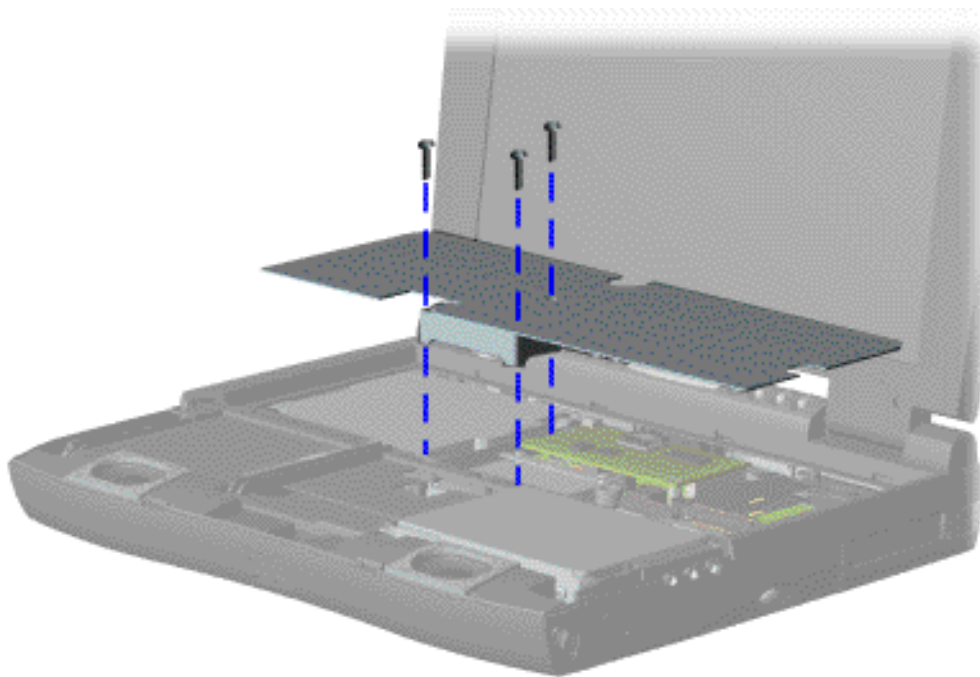
[Electrostatic Discharge](#)[Service Considerations](#)[Cables and Connectors](#)[Preparing the Computer for Disassembly](#)[Battery Pack](#)[Palmrest Cover with Touch Pad](#)[Keyboard](#)[Heatspreader](#)[Modem](#)[Processor](#)[Status Panel](#)[Interface Board](#)[Hard Drives](#)

To remove the heatspreader, complete the following steps:

1. [Prepare the computer for disassembly.](#)
2. Remove the [palmrest cover with touch pad.](#)
3. Remove the [keyboard.](#)
4. Remove three screws from the heatspreader and lift out of the chassis.

To replace

[Battery
Charger Board](#)

[CD Drive](#)

[Display Panel
Assembly](#)

[Upper CPU
Cover](#)

[Speaker
Assembly](#)

[Diskette Drive](#)

[Fan Assembly](#)

[Audio Board](#)

[System Board](#)

[Memory
Module](#)

the
heatspreader,
reverse the
previous
procedures.

[1.800.AT.COMPAQ](#)

[privacy and legal statement](#)

Maintenance & Service Guide

Presario 1600 Series

Models: 1650 and 1655

[Home Page](#) | [Notice](#) | [Preface](#) | [Product Description](#) | [Troubleshooting](#)
[Illustrated Parts Catalog](#) | [Removal & Replacement Procedures](#) | [Specifications](#)
[Pin Assignments](#) | [Battery Pack Operations](#)

Removing the Modem

[Electrostatic Discharge](#)

[Service Considerations](#)

[Cables and Connectors](#)

[Preparing the Computer for Disassembly](#)

[Battery Pack](#)

[Palmrest Cover with Touch Pad](#)

[Keyboard](#)

[Heatspreader](#)

[Modem](#)

[Processor](#)

[Status Panel](#)

[Interface Board](#)

[Hard Drives](#)

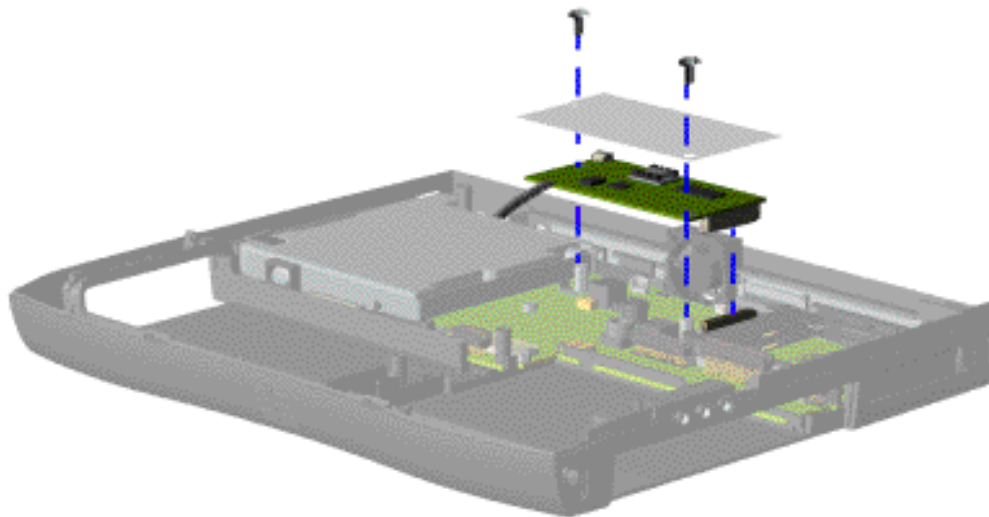

To remove the modem and shield, complete the following steps:

1. Prepare the [computer for disassembly](#).
2. Remove the [palmrest cover with touch pad](#).
3. Remove the [keyboard](#).
4. Remove the [heatspreader](#).
5. Remove two screws securing the

[Battery](#)

[Charger Board](#)

[CD Drive](#)

[Display Panel
Assembly](#)

[Upper CPU
Cover](#)

[Speaker
Assembly](#)

[Diskette Drive](#)

[Fan Assembly](#)

[Audio Board](#)

[System Board](#)

[Memory
Module](#)

shield and
modem, lift
off the
shield, and
pull the
modem off
the
connector on
the system
board.

[Next Step](#)

[1.800.AT.COMPAQ](#)

[privacy and legal statement](#)

COMPAQ

[STORE](#) | [PRODUCTS](#) | [SERVICES](#) | [SUPPORT](#) | [CONTACT US](#) | [SEARCH](#)

Maintenance & Service Guide

Presario 1600 Series

Models: 1650 and 1655

[Home Page](#) | [Notice](#) | [Preface](#) | [Product Description](#) | [Troubleshooting](#)
[Illustrated Parts Catalog](#) | [Removal & Replacement Procedures](#) | [Specifications](#)
[Pin Assignments](#) | [Battery Pack Operations](#)

Removing the Processor

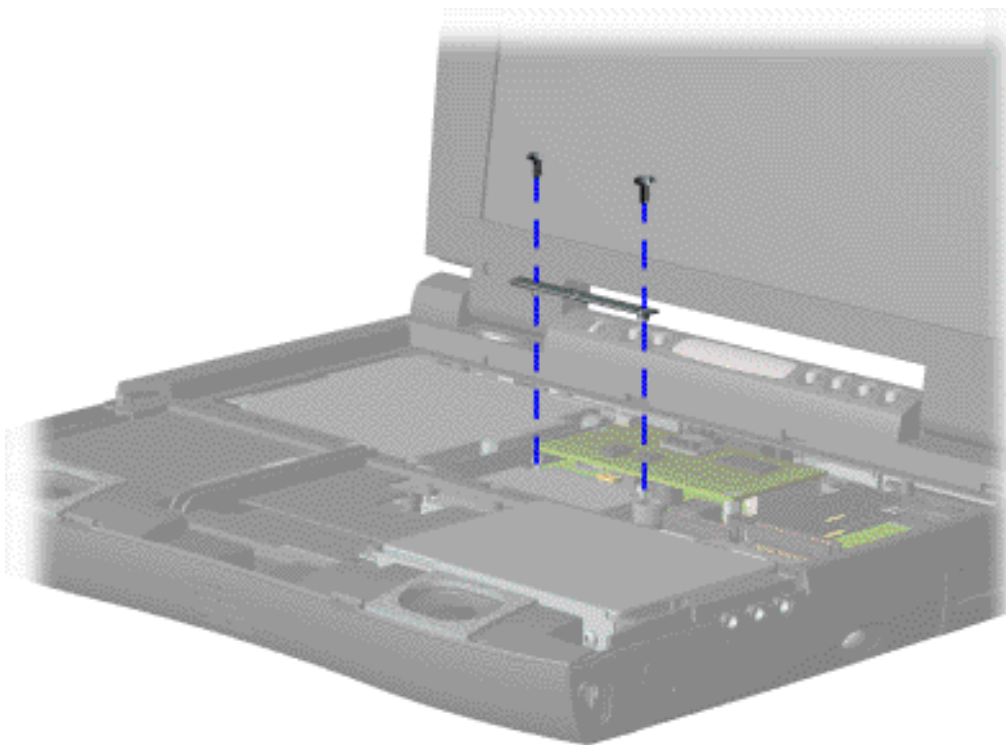
[Electrostatic Discharge](#)[Service Considerations](#)[Cables and Connectors](#)[Preparing the Computer for Disassembly](#)[Battery Pack](#)[Palmrest Cover with Touch Pad](#)[Keyboard](#)[Heatspreader](#)[Modem](#)[Processor](#)[Status Panel](#)[Interface Board](#)[Hard Drives](#)

To remove the processor, complete the following steps:

1. [Prepare the computer for disassembly.](#)
2. Remove the [palmrest cover with touch pad.](#)
3. Remove the [keyboard.](#)
4. Remove the [heatspreader.](#)
5. Remove the [modem.](#)

[Battery](#)

[Charger Board](#)

[CD Drive](#)

[Display Panel
Assembly](#)

[Upper CPU
Cover](#)

[Speaker
Assembly](#)

[Diskette Drive](#)

[Fan Assembly](#)

[Audio Board](#)

[System Board](#)

[Memory
Module](#)

6. Remove two screws securing the processor bracket.

[Next Step](#)

1.800.AT.COMPAQ

[privacy and legal statement](#)

Maintenance & Service Guide

Presario 1600 Series

Models: 1650 and 1655

[Home Page](#) | [Notice](#) | [Preface](#) | [Product Description](#) | [Troubleshooting](#)
[Illustrated Parts Catalog](#) | [Removal & Replacement Procedures](#) | [Specifications](#)
[Pin Assignments](#) | [Battery Pack Operations](#)

Removing the Status Panel

| |
|--|
| Electrostatic Discharge |
| Service Considerations |
| Cables and Connectors |
| Preparing the Computer for Disassembly |
| Battery Pack |
| Palmrest Cover with Touch Pad |
| Keyboard |
| Heatspreader |
| Modem |
| Processor |
| Status Panel |
| Interface Board |
| Hard Drives |
| Battery Charger Board |
| CD Drive |

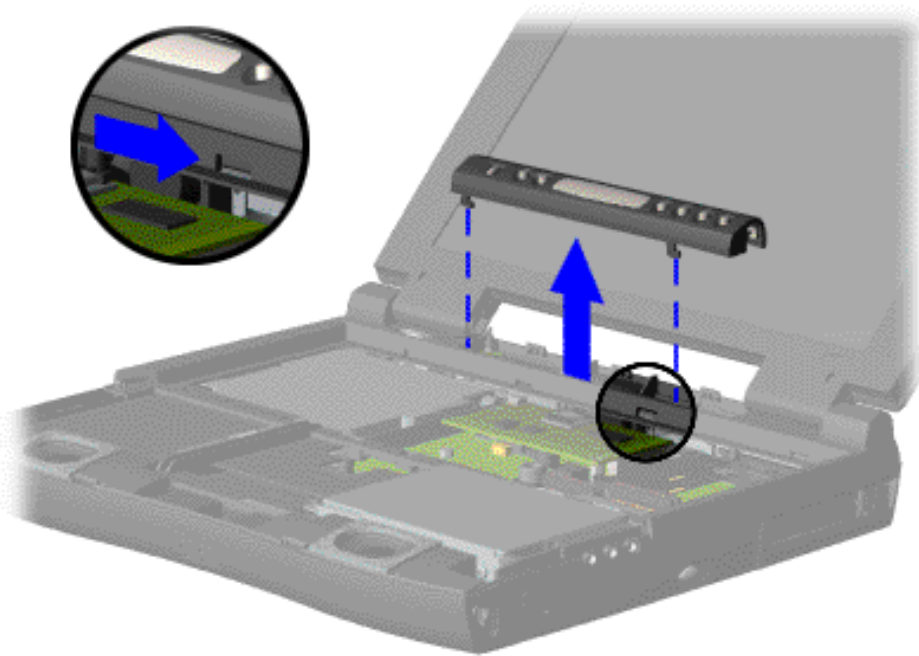

To remove the status panel, complete the following steps:

1. [Prepare the computer for disassembly.](#)
2. [Remove the palmrest cover with touch pad.](#)
3. [Remove the keyboard.](#)
4. Move the lever (located below the CD Play button on the status panel) to the right to release the status panel cover.
5. Support the front bottom corners of the status panel with the thumb and forefinger. Lift up the status panel off the chassis.

[Next Step](#)

[Display Panel Assembly](#)

[Upper CPU Cover](#)

[Speaker Assembly](#)

[Diskette Drive](#)

[Fan Assembly](#)

[Audio Board](#)

[System Board](#)

[Memory Module](#)

| | | | | | |
|-----------------------------|------------------------|--------------------------|-------------------------|---------------------------|----------------------------|
| Compaq Home | Search | Products | Service | Worldwide | Compaq.com |
|-----------------------------|------------------------|--------------------------|-------------------------|---------------------------|----------------------------|

[Comments?](#)

[Legal Notices and Privacy Statement](#)

Revised: dd Month 1998

[1.800.AT.COMPAQ](#)

[privacy and legal statement](#)

Maintenance & Service Guide

Presario 1600 Series

Models: 1650 and 1655

[Home Page](#) | [Notice](#) | [Preface](#) | [Product Description](#) | [Troubleshooting](#)
[Illustrated Parts Catalog](#) | [Removal & Replacement Procedures](#) | [Specifications](#)
[Pin Assignments](#) | [Battery Pack Operations](#)

Removing the Interface Board with Header

[Electrostatic Discharge](#)

[Service Considerations](#)

[Cables and Connectors](#)

[Preparing the Computer for Disassembly](#)

[Battery Pack](#)

[Palmrest Cover with Touch Pad](#)

[Keyboard](#)

[Heatspreader](#)

[Modem](#)

[Processor](#)

[Status Panel](#)

[Interface Board](#)

[Hard Drives](#)

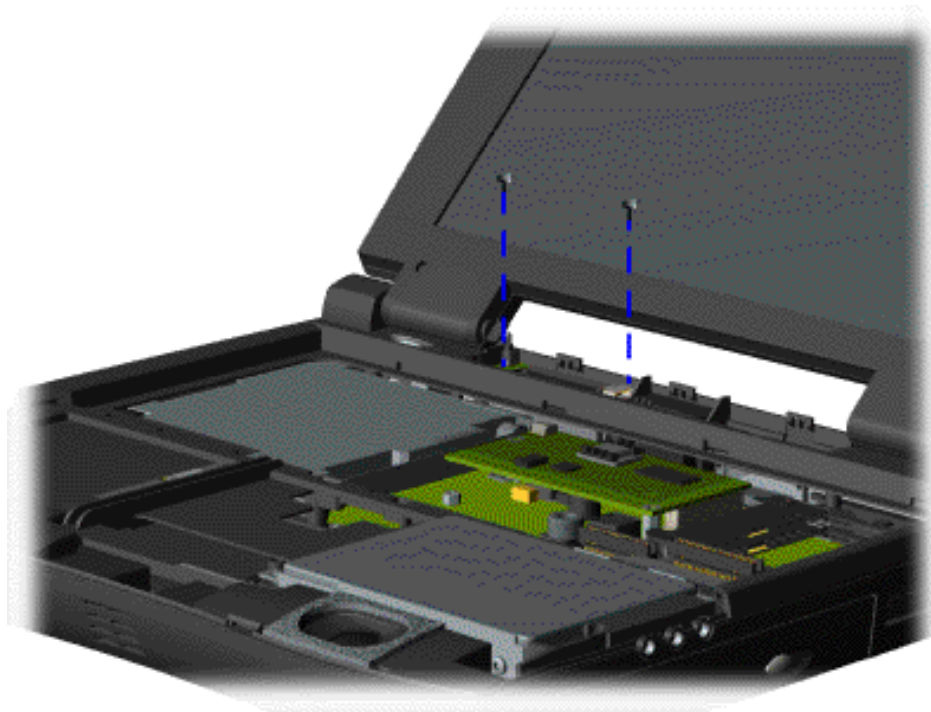

To remove the interface board with header, complete the following steps:

1. Prepare the computer for disassembly.
2. Remove the palmrest cover with touch pad.
3. Remove the keyboard.
4. Remove the status panel.
5. Remove the two screws from the interface board.

[Next Step](#)

[Battery
Charger Board](#)

[CD Drive](#)

[Display Panel
Assembly](#)

[Upper CPU
Cover](#)

[Speaker
Assembly](#)

[Diskette Drive](#)

[Fan Assembly](#)

Audio Board

[System Board](#)

[Memory
Module](#)

| | | | | | |
|-----------------------------|------------------------|--------------------------|-------------------------|---------------------------|----------------------------|
| Compaq Home | Search | Products | Service | Worldwide | Compaq.com |
|-----------------------------|------------------------|--------------------------|-------------------------|---------------------------|----------------------------|

[Comments?](#)

[Legal Notices and Privacy Statement](#)

Revised: dd Month 1998

1.800.AT.COMPAQ

[privacy and legal statement](#)

COMPAQ

[STORE](#) | [PRODUCTS](#) | [SERVICES](#) | [SUPPORT](#) | [CONTACT US](#) | [SEARCH](#)

Maintenance & Service Guide

Presario 1600 Series

Models: 1650 and 1655

[Home Page](#) | [Notice](#) | [Preface](#) | [Product Description](#) | [Troubleshooting](#)
[Illustrated Parts Catalog](#) | [Removal & Replacement Procedures](#) | [Specifications](#)
[Pin Assignments](#) | [Battery Pack Operations](#)

Removing the 5.0-GB or 4.0-GB Hard Drives

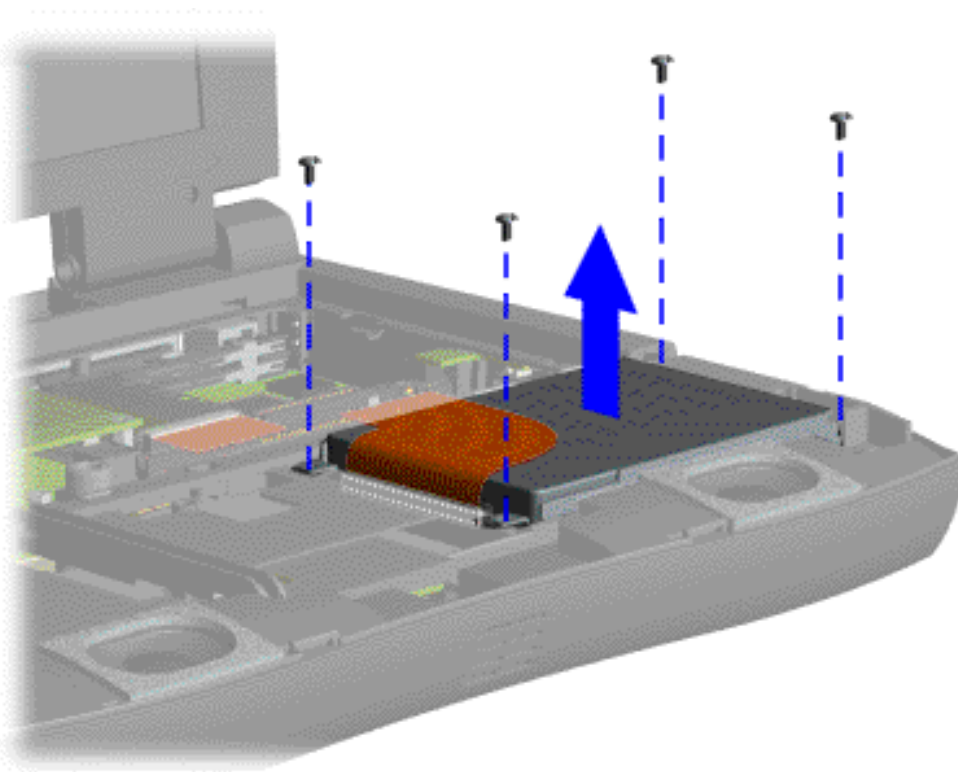
[Electrostatic Discharge](#)[Service Considerations](#)[Cables and Connectors](#)[Preparing the Computer for Disassembly](#)[Battery Pack](#)[Palmrest Cover with Touch Pad](#)[Keyboard](#)[Heatspreader](#)[Modem](#)[Processor](#)[Status Panel](#)[Interface Board](#)

To remove the hard drive with the hard drive bracket attached, complete the following steps:

1. Prepare the [computer for disassembly](#).

2. Remove the [palmrest cover with touch pad](#).

3. Remove four screws from the hard drive

| |
|--|
| Hard Drives |
| Battery |
| Charger Board |
| CD Drive |
| Display Panel Assembly |
| Upper CPU Cover |
| Speaker Assembly |
| Diskette Drive |
| Fan Assembly |
| Audio Board |
| System Board |
| Memory Module |

mounting bracket and lift up the hard drive.

[Next Step](#)

1.800.AT.COMPAQ

[privacy and legal statement](#)

COMPAQ

[STORE](#) | [PRODUCTS](#) | [SERVICES](#) | [SUPPORT](#) | [CONTACT US](#) | [SEARCH](#)

Maintenance & Service Guide

Presario 1600 Series

Models: 1650 and 1655

[Home Page](#) | [Notice](#) | [Preface](#) | [Product Description](#) | [Troubleshooting](#)
[Illustrated Parts Catalog](#) | [Removal & Replacement Procedures](#) | [Specifications](#)
[Pin Assignments](#) | [Battery Pack Operations](#)

Removing the Battery Charger Board

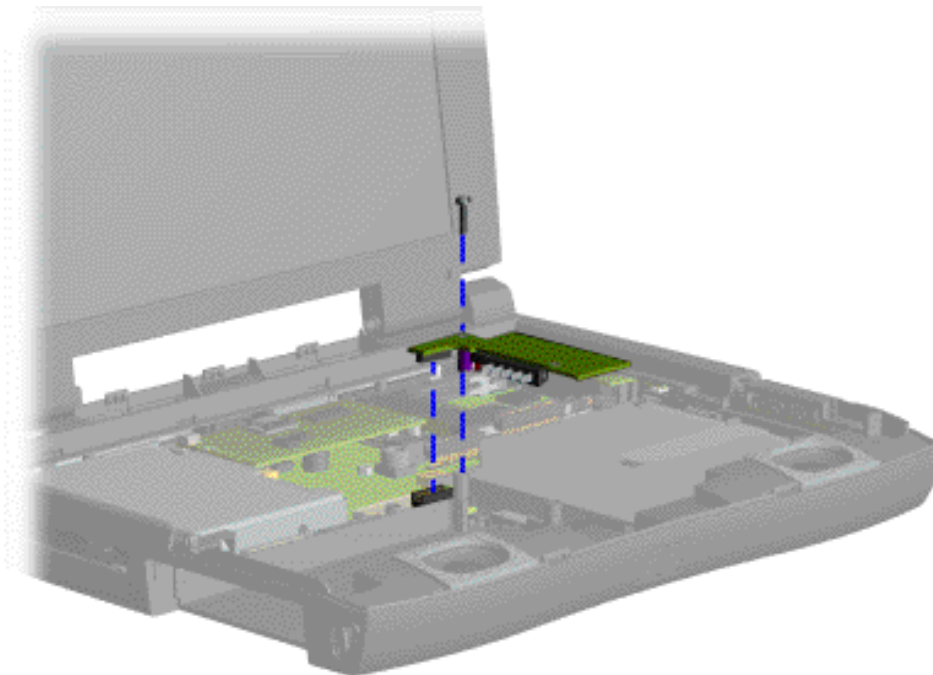
[Electrostatic Discharge](#)[Service Considerations](#)[Cables and Connectors](#)[Preparing the Computer for Disassembly](#)[Battery Pack](#)[Palmrest Cover with Touch Pad](#)[Keyboard](#)[Heatspreader](#)[Modem](#)[Processor](#)[Status Panel](#)[Interface Board](#)

To remove the battery charger board, complete the following steps:

1. Prepare the [computer for disassembly](#).
2. Remove the [palmrest cover with touch pad](#).
3. Remove the [keyboard](#).
4. Remove the [hard drive](#).
5. Remove the [stiffener bracket](#).
6. Remove screw from the battery charger board, unplug the board from the connector on the system board,

[Hard Drives](#)

[Battery
Charger Board](#)

[CD Drive](#)

[Display Panel
Assembly](#)

[Upper CPU
Cover](#)

[Speaker
Assembly](#)

[Diskette Drive](#)

[Fan Assembly](#)

[Audio Board](#)

[System Board](#)

[Memory
Module](#)

and lift out of the chassis.

To replace the battery charger board, reverse the previous procedures.

NOTE: When replacing the battery charger board, ensure the pins are aligned with the connector on the system board.

1.800.AT.COMPAQ

[privacy and legal statement](#)

Maintenance & Service Guide

Presario 1600 Series

Models: 1650 and 1655

[Home Page](#) | [Notice](#) | [Preface](#) | [Product Description](#) | [Troubleshooting](#)
[Illustrated Parts Catalog](#) | [Removal & Replacement Procedures](#) | [Specifications](#)
[Pin Assignments](#) | [Battery Pack Operations](#)

Removing the CD Drive

[Electrostatic Discharge](#)

[Service Considerations](#)

[Cables and Connectors](#)

[Preparing the Computer for Disassembly](#)

[Battery Pack](#)

[Palmrest Cover with Touch Pad](#)

[Keyboard](#)

[Heatspreader](#)

[Modem](#)

[Processor](#)

[Status Panel](#)

[Interface Board](#)

[Hard Drives](#)

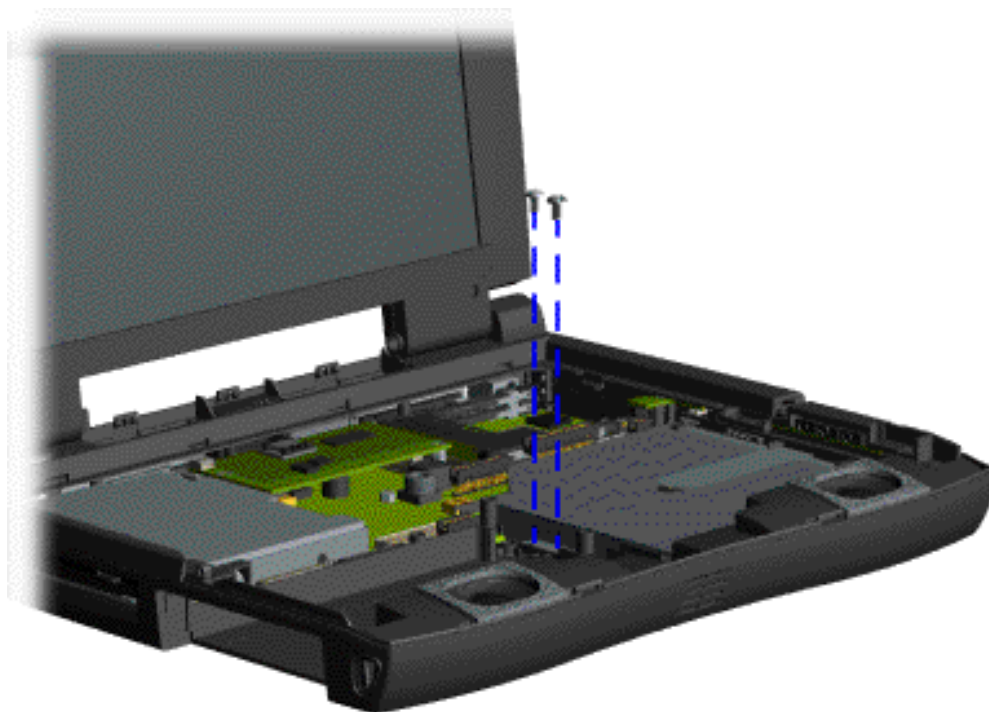

To remove the CD drive, complete the following steps:

1. Prepare the [computer for disassembly](#).
2. Remove the [palmrest cover with touch pad](#).
3. Remove the [keyboard](#).
4. Remove the [heatspreader](#).
4. Remove the [hard drive](#).

- [Battery
Charger Board](#)
- [CD Drive](#)
- [Display Panel
Assembly](#)
- [Upper CPU
Cover](#)
- [Speaker
Assembly](#)
- [Diskette Drive](#)
- [Fan Assembly](#)
- [Audio Board](#)
- [System Board](#)
- [Memory
Module](#)

5. Remove the [stiffener bracket](#).

6. Remove the [battery charger board](#).

7. Remove two screws located at the back CD drive.

[Next Step](#)

1.800.AT.COMPAQ

[privacy and legal statement](#)

Maintenance & Service Guide

Presario 1600 Series

Models: 1650 and 1655

[Home Page](#) | [Notice](#) | [Preface](#) | [Product Description](#) | [Troubleshooting](#)
[Illustrated Parts Catalog](#) | [Removal & Replacement Procedures](#) | [Specifications](#)
[Pin Assignments](#) | [Battery Pack Operations](#)

Removing the Display Panel Assembly

[Electrostatic Discharge](#)

[Service Considerations](#)

[Cables and Connectors](#)

[Preparing the Computer for Disassembly](#)

[Battery Pack](#)

[Palmrest Cover with Touch Pad](#)

[Keyboard](#)

[Heatspreader](#)

[Modem](#)

[Processor](#)

[Status Panel](#)

[Interface Board](#)

[Hard Drives](#)

[Battery Charger Board](#)

[CD Drive](#)

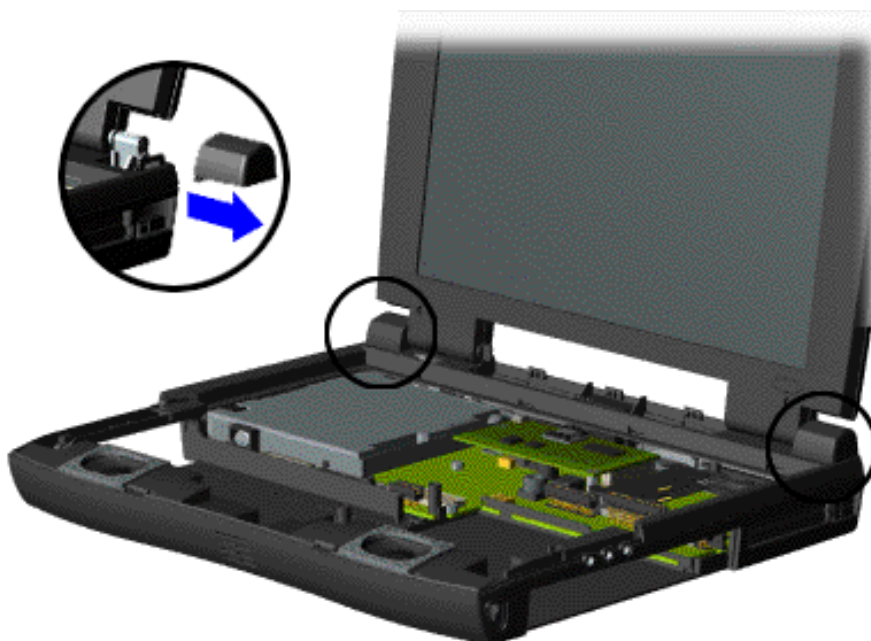

To remove the display panel assembly, complete the following steps:

1. [Prepare the computer for disassembly.](#)
2. Remove the [palmrest cover with touch pad.](#)
3. Remove the [keyboard.](#)
4. Remove the [heatspreader.](#)
5. Remove the [status panel.](#)
6. Remove the [interface board.](#)
7. Grasp the hinge covers, pull out and lift the covers off the chassis.

[Display Panel Assembly](#)

[Upper CPU Cover](#)

[Speaker Assembly](#)

[Diskette Drive](#)

[Fan Assembly](#)

[Audio Board](#)

[System Board](#)

[Memory Module](#)

IMPORTANT: Carefully remove the display panel assembly hinge covers.

[Next Step](#)

1.800.AT.COMPAQ

[privacy and legal statement](#)

Maintenance & Service Guide

Presario 1600 Series

Models: 1650 and 1655

[Home Page](#) | [Notice](#) | [Preface](#) | [Product Description](#) | [Troubleshooting](#)
[Illustrated Parts Catalog](#) | [Removal & Replacement Procedures](#) | [Specifications](#)
[Pin Assignments](#) | [Battery Pack Operations](#)

Removing the Upper CPU Cover

| |
|--|
| Electrostatic Discharge |
| Service Considerations |
| Cables and Connectors |
| Preparing the Computer for Disassembly |
| Battery Pack |
| Palmrest Cover with Touch Pad |
| Keyboard |
| Heatspreader |
| Modem |
| Processor |

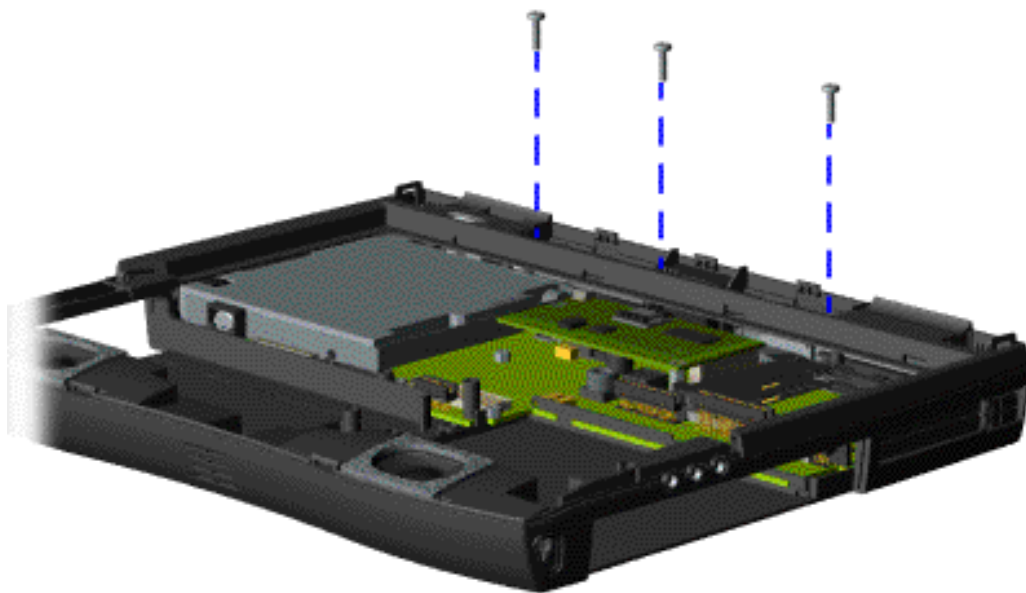

To remove the Upper CPU cover complete the following steps:

1. Prepare the [computer for disassembly](#).
2. Remove the screw located under the bottom of the unit near the battery pack which secures the Upper CPU cover to the chassis.
3. Remove the [palmrest](#)

| |
|--|
| Status Panel |
| Interface Board |
| Hard Drives |
| Battery Charger Board |
| CD Drive |
| Display Panel Assembly |
| Upper CPU Cover |
| Speaker Assembly |
| Diskette Drive |
| Fan Assembly |
| Audio Board |
| System Board |
| Memory Module |

[cover with touch pad.](#)

4. Remove the [keyboard](#).

5. Remove the [heatspreader](#).

6. Remove the [display panel assembly](#).

7. Remove three screws located on the top and release the snap located in the left corner of the Upper CPU cover.

To replace the Upper CPU cover, reverse the previous procedures.

1.800.AT.COMPAQ

[privacy and legal statement](#)

Maintenance & Service Guide

Presario 1600 Series

Models: 1650 and 1655

[Home Page](#) | [Notice](#) | [Preface](#) | [Product Description](#) | [Troubleshooting](#)
[Illustrated Parts Catalog](#) | [Removal & Replacement Procedures](#) | [Specifications](#)
[Pin Assignments](#) | [Battery Pack Operations](#)

Removing the Speaker Assembly

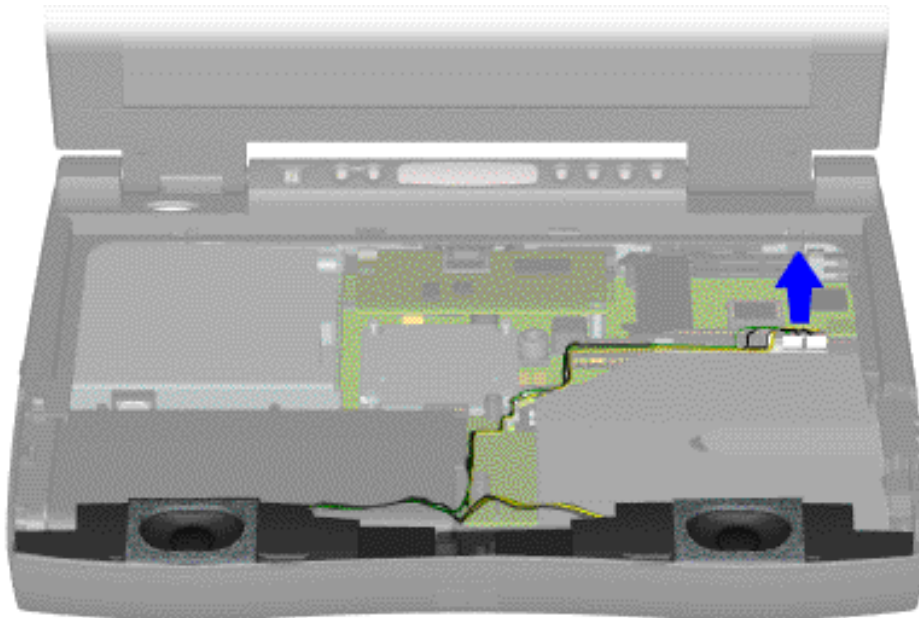

To remove the speaker assembly, complete the following steps:

1. Prepare the [computer for disassembly](#).
2. Remove the [palmrest cover with touch pad](#).
3. Remove the [keyboard](#).
4. Remove the [heatspreader](#).
5. Remove the [hard drive](#).
6. Remove the [stiffener bracket](#).
7. Remove the [display panel assembly](#).
8. Remove the [CD](#)

[Electrostatic Discharge](#)

[Service Considerations](#)

[Cables and Connectors](#)

[Preparing the Computer for Disassembly](#)

[Battery Pack](#)

[Palmrest Cover with Touch Pad](#)

- [Keyboard](#)
- [Heatspreader](#)
- [Modem](#)
- [Processor](#)
- [Status Panel](#)
- [Interface Board](#)
- [Hard Drives](#)
- [Battery Charger Board](#)
- [CD Drive](#)
- [Display Panel Assembly](#)
- [Upper CPU Cover](#)
- [Speaker Assembly](#)
- [Diskette Drive](#)
- [Fan Assembly](#)
- [Audio Board](#)
- [System Board](#)
- [Memory Module](#)

[drive.](#)

9. Disconnect the speaker cables from the system board and remove the speaker assembly from the chassis.

NOTE:

The speaker cables must be properly routed when replacing the speaker assembly. Place the cables in such a manner that they cannot be caught or snagged by screws.

For more information refer to the section on [speaker assembly cable position.](#)

To replace the speaker assembly, reverse the previous procedures.

[privacy and legal statement](#)

Maintenance & Service Guide

Presario 1600 Series

Models: 1650 and 1655

[Home Page](#) | [Notice](#) | [Preface](#) | [Product Description](#) | [Troubleshooting](#)
[Illustrated Parts Catalog](#) | [Removal & Replacement Procedures](#) | [Specifications](#)
[Pin Assignments](#) | [Battery Pack Operations](#)

Removing the Diskette Drive

[Electrostatic Discharge](#)

To remove the diskette drive, complete the following steps:

[Service Considerations](#)

1. [Prepare the computer for disassembly.](#)
2. Remove the [palmrest cover with touch pad.](#)

[Cables and Connectors](#)

3. Remove the [keyboard.](#)

[Preparing the Computer for Disassembly](#)

4. Remove the [heatspreader.](#)
5. Remove the [display panel assembly.](#)

[Battery Pack](#)

6. Remove the [Upper CPU cover.](#)

[Palmrest Cover with Touch Pad](#)

[Next Step](#)

[Keyboard](#)

[Heatspreader](#)

[Modem](#)

[Processor](#)

[Status Panel](#)

[Interface Board](#)

NOTE: Ensure the diskette drive eject lever is properly inserted in the chassis slot, when replacing the diskette drive.

[Hard Drives](#)

[Battery](#)

[Charger Board](#)

[CD Drive](#)

[Display Panel
Assembly](#)

[Upper CPU
Cover](#)

[Speaker
Assembly](#)

[Diskette Drive](#)

[Fan Assembly](#)

[Audio Board](#)

[System Board](#)

[Memory
Module](#)

[1.800.AT.COMPAQ](#)

[privacy and legal statement](#)

Maintenance & Service Guide

Presario 1600 Series

Models: 1650 and 1655

| [Home Page](#) | [Notice](#) | [Preface](#) | [Product Description](#) | [Troubleshooting](#)
[Illustrated Parts Catalog](#) | [Removal & Replacement Procedures](#) | [Specifications](#)
[Pin Assignments](#) | [Battery Pack Operations](#)

Removing the Fan Assembly

[Electrostatic Discharge](#)

[Service Considerations](#)

[Cables and Connectors](#)

[Preparing the Computer for Disassembly](#)

[Battery Pack](#)

[Palmrest Cover with Touch Pad](#)

[Keyboard](#)

[Heatspreader](#)

[Modem](#)

[Processor](#)

[Status Panel](#)

[Interface Board](#)

[Hard Drives](#)

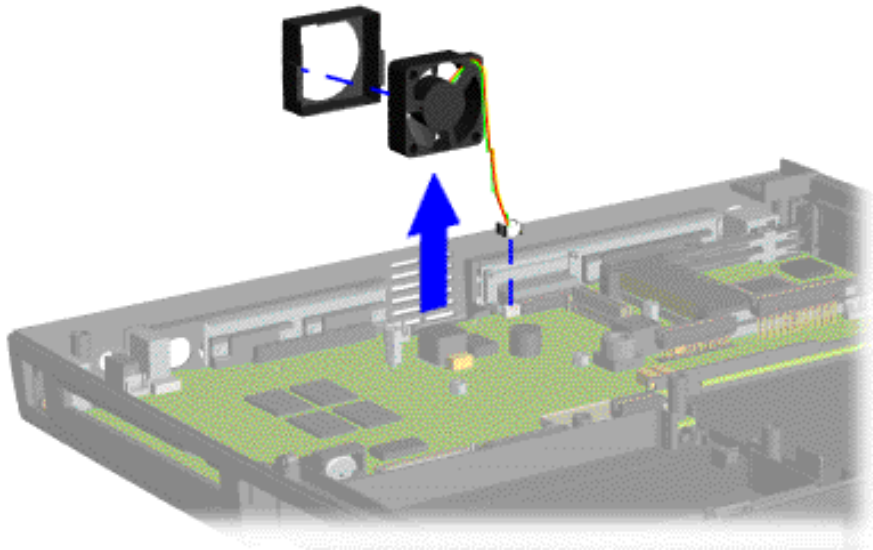

To remove the fan assembly, complete the following steps:

1. Prepare the [computer for disassembly](#).
2. Remove the [palmrest cover with touch pad](#).
3. Remove the [keyboard](#).
4. Remove the [heatspreader](#).
5. Remove the [display panel assembly](#).
6. Remove the [Upper CPU cover](#).
7. Disconnect the fan cable from the connector on the system board. Pull the fan from the chassis slot.

To remove the fan gasket, complete the following step:

Pull the gasket from the fan.

- [Battery](#)
- [Charger Board](#)
- [CD Drive](#)
- [Display Panel Assembly](#)
- [Upper CPU Cover](#)
- [Speaker Assembly](#)
- [Diskette Drive](#)
- [Fan Assembly](#)
- [Audio Board](#)
- [System Board](#)
- [Memory Module](#)

IMPORTANT: Replace the fan gasket, place the fan at a 15 degree angle, and push forward to replace the fan assembly.

To replace the fan assembly, reverse the previous procedures.

1.800.AT.COMPAQ

[privacy and legal statement](#)

Maintenance & Service Guide

Presario 1600 Series

Models: 1650 and 1655

[Home Page](#) | [Notice](#) | [Preface](#) | [Product Description](#) | [Troubleshooting](#)
[Illustrated Parts Catalog](#) | [Removal & Replacement Procedures](#) | [Specifications](#)
[Pin Assignments](#) | [Battery Pack Operations](#)

Removing the System Board

[Electrostatic Discharge](#)

To remove the system board, complete the following steps:

[Service Considerations](#)

1. Prepare the [computer for disassembly](#).

[Cables and Connectors](#)

2. Remove the [palmrest cover with touch pad](#).

[Preparing the Computer for Disassembly](#)

3. Remove the [keyboard](#).

[Battery Pack](#)

4. Remove the [heatspreader](#).

[Palmrest Cover with Touch Pad](#)

5. Remove the [processor](#).

[Keyboard](#)

6. Remove the [status panel](#).

[Heatspreader](#)

7. Remove the [interface board](#).

[Modem](#)

8. Remove the [modem](#).

[Processor](#)

9. Remove the [hard drive](#).

[Status Panel](#)

10. Remove the [stiffener bracket](#).

[Interface Board](#)

11. Remove the [battery charger board](#).

[Hard Drives](#)

12. Remove the [CD drive](#).

[Battery
Charger Board](#)

13. Remove the [display panel assembly](#).

[CD Drive](#)

14. Remove the [Upper CPU Cover](#).

[Display Panel
Assembly](#)

15. Remove the [diskette drive](#).

[Upper CPU
Cover](#)

16. Remove the [fan](#).

[Speaker
Assembly](#)

17. Remove the [audio board](#).

[Diskette Drive](#)

18. Disconnect the [speaker assembly](#) cables.

[Fan Assembly](#)

[Next Step](#)

[Audio Board](#)

[System Board](#)

[Memory
Module](#)

1.800.AT.COMPAQ

[privacy and legal statement](#)

COMPAQ

[STORE](#) | [PRODUCTS](#) | [SERVICES](#) | [SUPPORT](#) | [CONTACT US](#) | [SEARCH](#)

Maintenance & Service Guide

Presario 1600 Series
Models: 1650 and 1655

[Home Page](#) | [Notice](#) | [Preface](#) | [Product Description](#) | [Troubleshooting](#)
[Illustrated Parts Catalog](#) | [Removal & Replacement Procedures](#) | [Specifications](#)
[Pin Assignments](#) | [Battery Pack Operations](#)

Removing the Memory Module

[Electrostatic Discharge](#)

[Service Considerations](#)

[Cables and Connectors](#)

[Preparing the Computer for Disassembly](#)

[Battery Pack](#)

[Palmrest Cover with Touch Pad](#)

[Keyboard](#)

[Heatspreader](#)

[Modem](#)

[Processor](#)

[Status Panel](#)

[Interface Board](#)

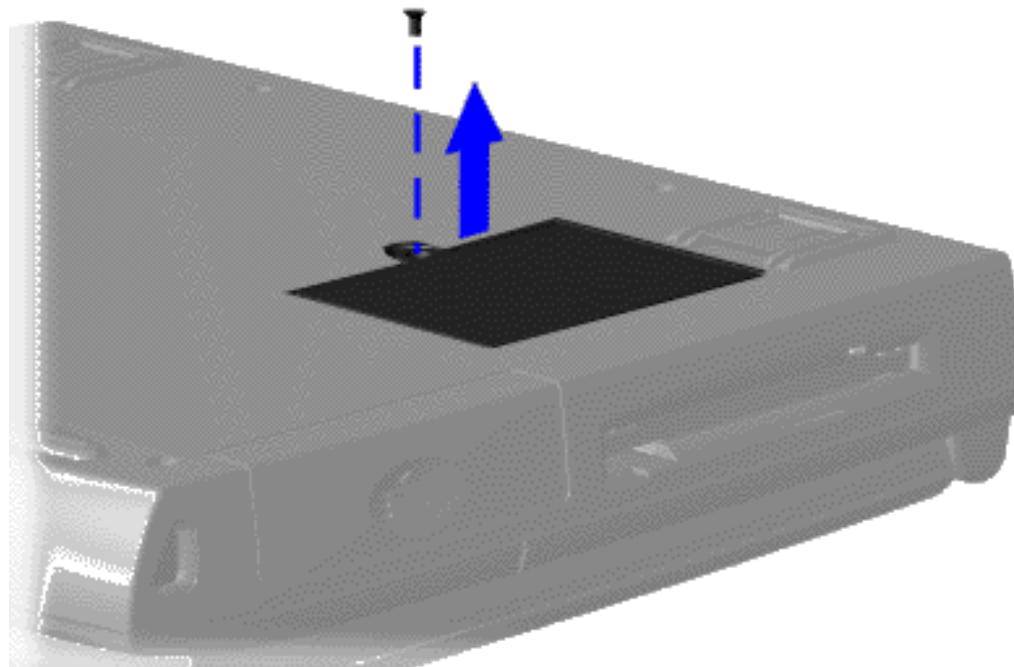

To remove the memory module, complete the following steps:

1. Prepare the [computer for disassembly](#).
2. Close the computer and turn the computer upside down.
3. Remove the screw from the memory module

[Hard Drives](#)

[Battery](#)

[Charger Board](#)

[CD Drive](#)

[Display Panel
Assembly](#)

[Upper CPU
Cover](#)

[Speaker
Assembly](#)

[Diskette Drive](#)

[Fan Assembly](#)

[Audio Board](#)

[System Board](#)

[Memory
Module](#)

door, and slide the memory module door to the right.

[Next Step](#)

1.800.AT.COMPAQ

[privacy and legal statement](#)